

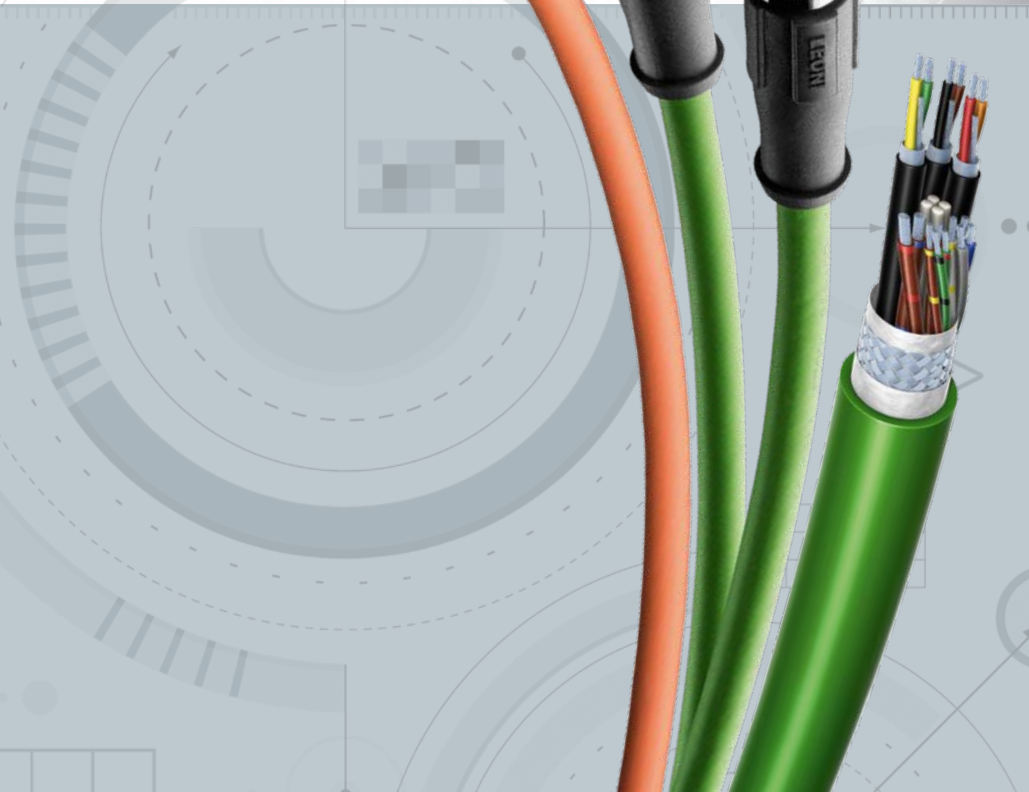

FieldLink®
Cable solutions for
Automation & Drives

The Quality Connection

LEONI

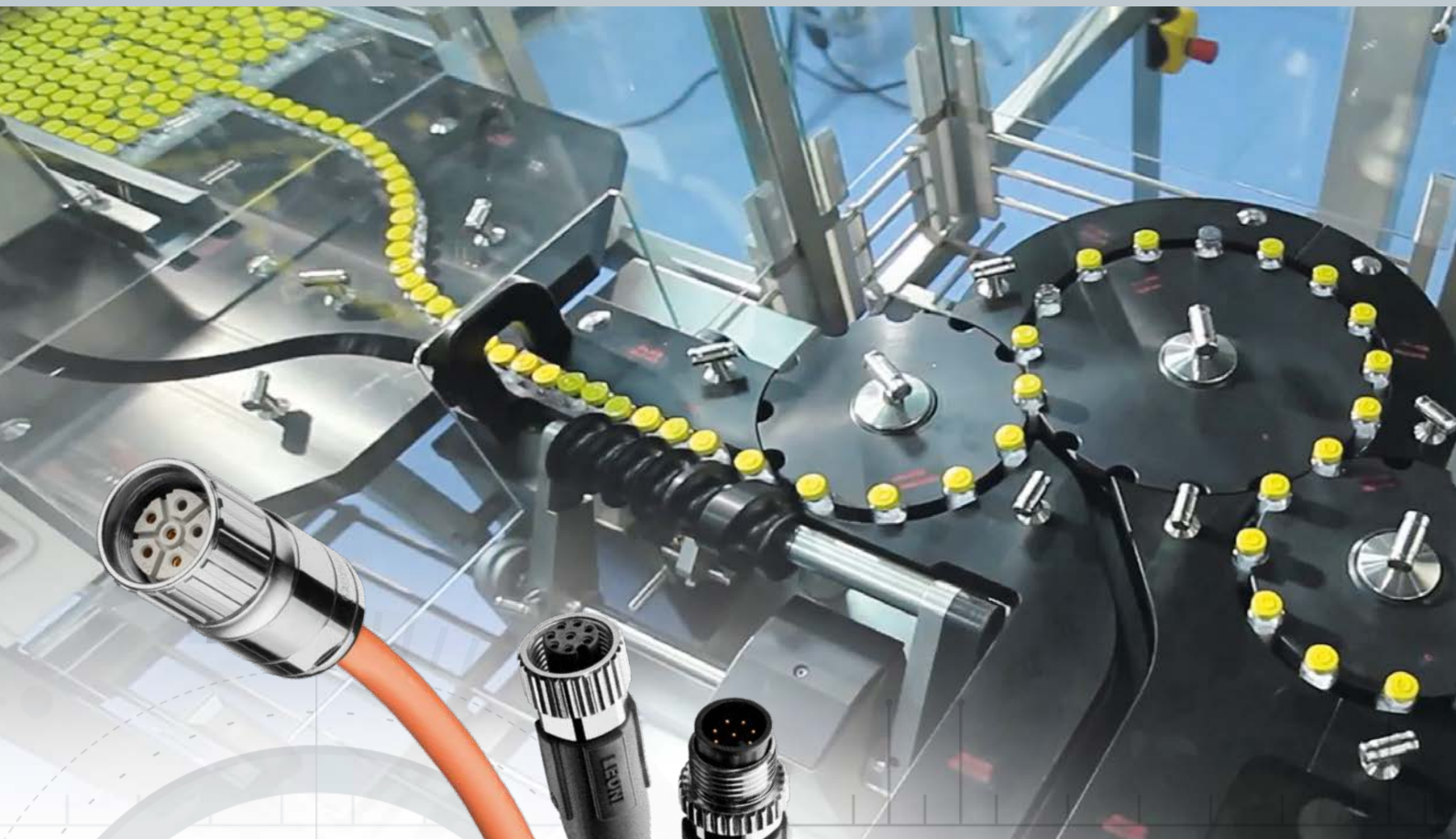

Issue 08/2018

All FieldLink® products are permanently enhanced for our customers. Therefore this brochure is subject to change and error. Up to all information on products, developments, research projects and trade fairs of the Business Unit Automation & Drives can also be found on the website: www.leoni-factory-automation.com

Indication:
Unless prior agreement, the general conditions of sale and delivery applying will be those of the concerned LEONI AG.



In state-of-the-art automation, the trend is towards ever more complex bus systems that have to cover all the data transfer from the supervisory to the actuator/sensor level on the machine via increasingly sophisticated cables.

At the same time, these new systems must match or exceed the assurance and reliability of existing industrial cabling.

The LEONI Group	4
Factory Automation in all it's diversity	5
Engineering · Products · Services	6
Fields of application	8
FieldLink® bus cables and Industrial Ethernet cables	10
FieldLink MC® Motion Control cables	54
Technical Information	72
Type designation for copper cables	73
Installation guide	74
Drag chain test centre	75
The significance of UL and CSA certifications	76
UL listed cable types	78
Flame tests	80
Quality and environment	86
Industrial expertise	87

The LEONI Group

Intelligent solutions for energy and data management



LEONI is a global provider of products, solutions and services for energy and data management in the automotive sector and other industries. The market-listed group of companies has more than 88,000 employees in 31 countries and generated consolidated sales of EUR 4.9 billion in 2017.

LEONI's largest customer group comprises the global car, commercial vehicle and component supply industry. LEONI furthermore supplies products and services to these markets: data communication & networks, healthcare, process industry, transportation, energy & infrastructure, factory automation, machinery & sensors as well as marine. An integrated network for research & development, production as well as distribution and service gives customers the assurance of tailor-made support at more than 90 locations around the globe. LEONI operates as a solutions provider with pronounced development and systems expertise.

Innovative solutions based on development and systems partnership

Especially in the automotive industry, LEONI offers substantial added value to motor vehicle manufacturers in both technological and commercial terms by being an innovation partner based on profound understanding of the overall system and by being involved in the early stages of development. In addition to standard and special cables as well as custom-developed wiring systems and related components, the

Company's offering also includes software solutions and such services as architecture design and simulation. LEONI concentrates its automotive research and development work on the sector's major trends such as electromobility, autonomous driving and connectivity – enhanced by lightweight construction solutions, multi-voltage and function integration, but also by logistics and engineering expertise.

Digital transformation thanks to intelligent products and smart services

LEONI pursues the aim of becoming a leading solutions provider of intelligent systems for the megatrends of energy transmission and data management. To achieve this, the Company's offering will in the future also include intelligent cables, cable systems and components – which is gaining importance particularly in the wake of digitalization and the development of fail-safe systems with a high level of connectivity. The Company is consequently enhancing its know-how in such fields as electronics, sensor technology and big data, and provides such customised smart services as predictive maintenance and error analyses. The digital transformation within LEONI manifests itself in digital processes and software expertise, which is used, for instance, to implement more automated production. Together with international customer networks and strategic partnerships, this is creating new, digital business models – individually tailored to customers' requirements.

For further information, please visit www.leoni.com

Factory Automation

in all its diversity



With innovative solutions for intelligent energy and data management in automated production processes, LEONI has been for years a preferred supplier of many automotive and factory automation OEMs. LEONI products are already facing up to the key future trend of digitalisation with an extensive and innovative range of complementary products and services in the market segments Automation, Drives and Robotics.

In several competence centres around the world, LEONI develops and produces bus cables, Industrial Ethernet and Motion Control cables as well as cable systems and services. Connector development and production as well as assembled drag chains round off the product portfolio. Moreover, LEONI supplies a wide variety of solutions, including robotic cables and their assembly, hoses and tubes, dresspack systems, integration-ready robots, robot programming and automation systems training. In view of the increasing digitalization LEONI provides integrated and intelligent sensor-based measuring and vision solutions e.g. for robot guidance, part identification, defect detection and assembly inspection. LEONI markets this product variety via a global sales organisation at nearly 50 locations.

Their sharp focus on service and increasing product diversification provides impetus for developing these markets further. With its product range LEONI confronts the market's challenges by way of ongoing collaboration with technology leaders and user organisations, and it actively develops products as well as services to meet the trends of the future, especially with respect to the increasing digitalisation. Thus, LEONI is taking an important step towards meeting future market requirements in a 'smart' way.

Engineering · Products · Services



1 FieldLink® bus cables

2 FieldLink® Industrial Ethernet cables

3 Fiber optic cables

4 FieldLink®MC cables and cable systems for Motion Control

5 Robotic cables

6 Hybrid cables

7 Polyurethane tubes & hoses, corrugated hoses

8 Electromechanical component assemblies

9 Assembly of standardised and special cables

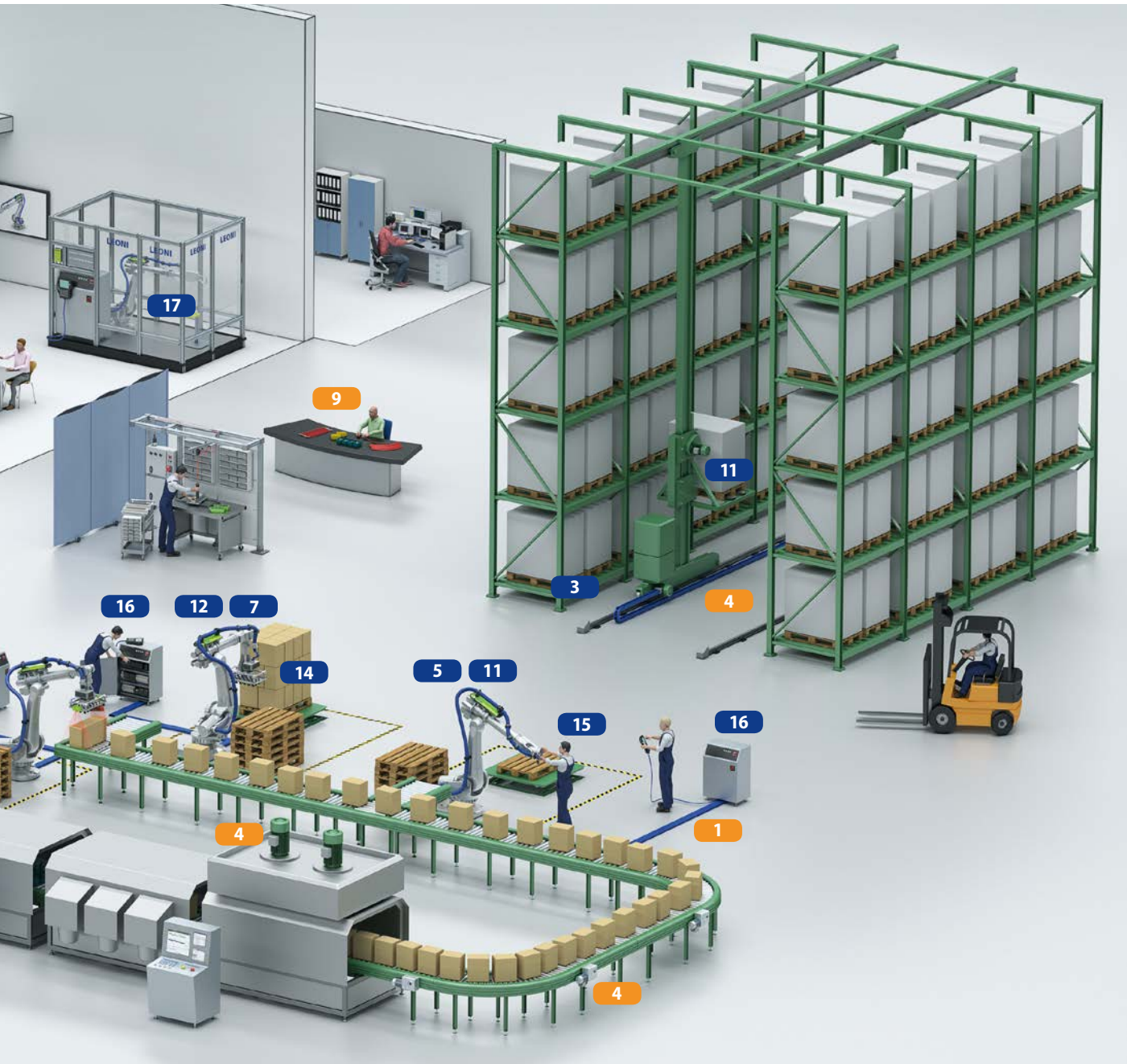

- | | |
|--|---------------------------------------|
| 10 Cable drag chain systems | 14 Machine vision systems |
| 11 Dresspack systems | 15 Installation & maintenance |
| 12 Robot function packages | 16 Robot & PLC programming |
| 13 advintec measurement and calibration systems | 17 Automation systems training |
| | 18 Project management |

Fields of application

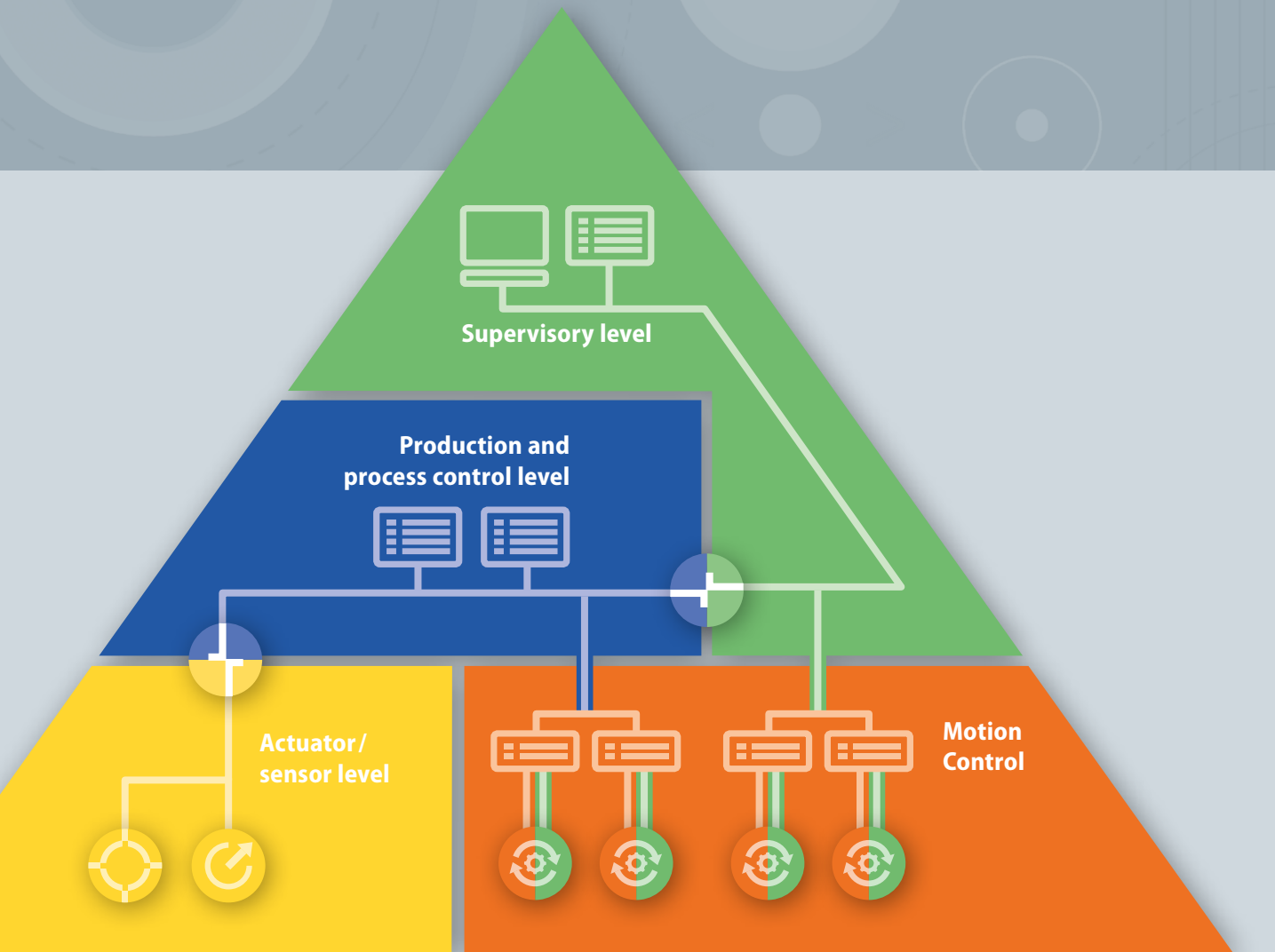

● Supervisory level

- IT communication – WAN
- Task: visualisation, archival, e.g. control post, interference indicating station

● Production and process control level

- Data communication – LAN
- Task: system control, e.g. reception, administration

● Actuator / sensor level

- Field communication (process signals)
- Task (operation level):
processing, e.g. regulation/control of realtime functions
- Task (drive control):
input and output, e.g. measure, regulate, move, switch

● Motion control

- Field communication and power supply
- Task:
drive control with input and output
and additional power supply

Product overview

FieldLink®

bus cables and Industrial Ethernet cables

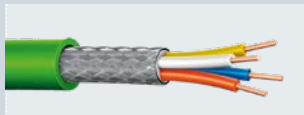

**Industrial Ethernet /
PROFINET**
page 11



PROFIBUS
page 24

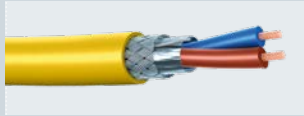

**Foundation™
Fieldbus**
page 34

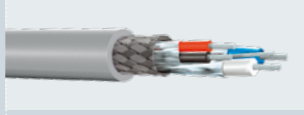

DeviceNet™
page 36

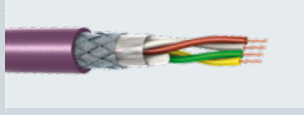

CAN
page 40

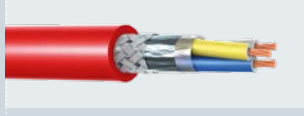

CC-Link®
page 44



KNX (EIB)
page 46

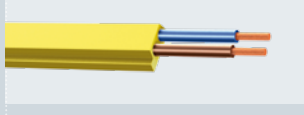

AS-Interface
page 48

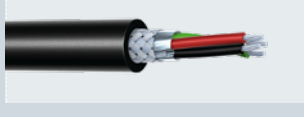

USB and Fire Wire
page 52

FieldLink® MC

cables for Motion Control



Feedback cables
analog and digital
page 55



Power cables
page 64

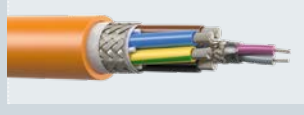

Hybrid cables
page 70

FieldLink® bus cables and Industrial Ethernet cables

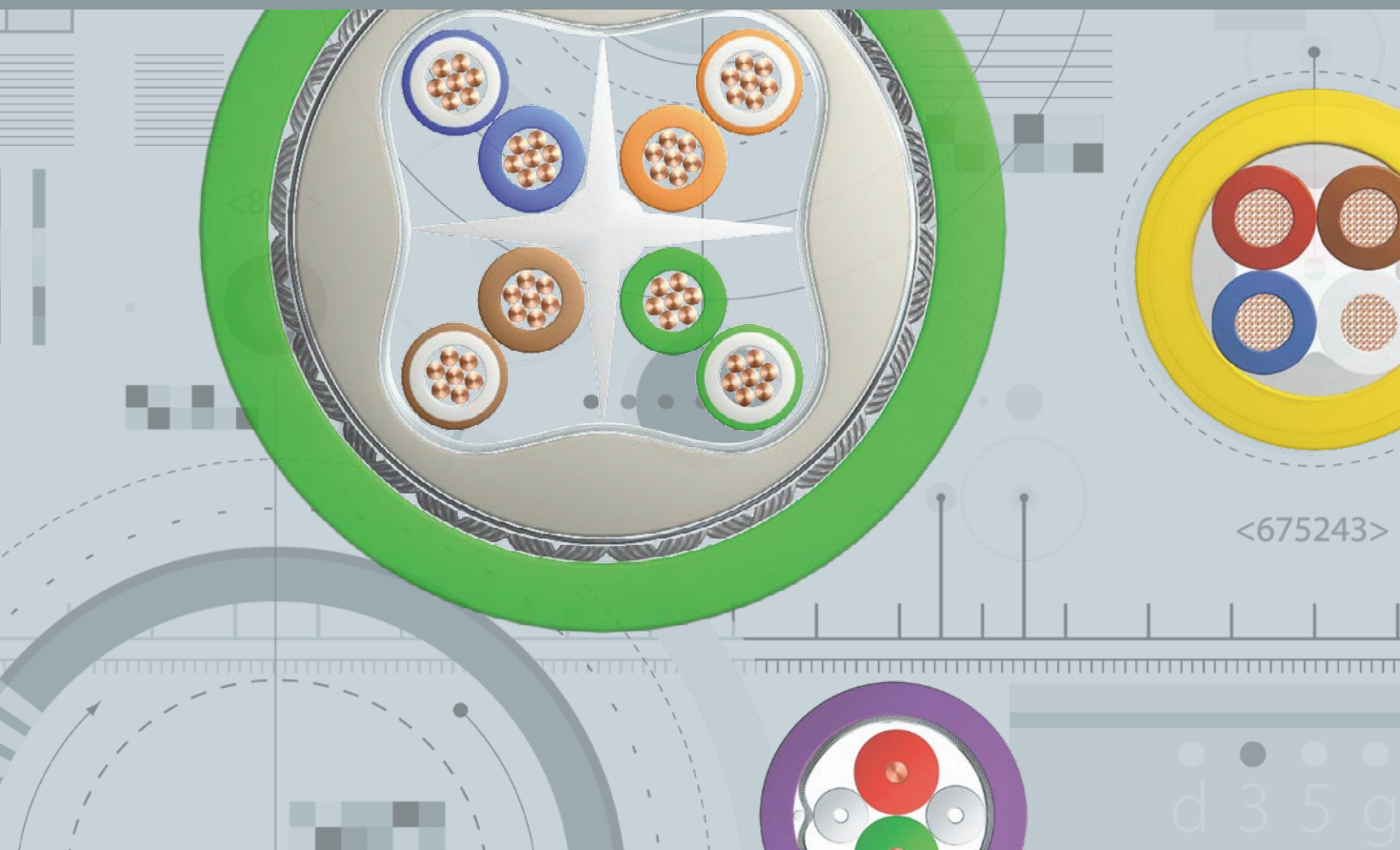

● ● ● The FieldLink-product family provides you with the optimum solution for all common bus systems: be they AS-Interface, FOUNDATION Fieldbus, PROFIBUS or PROFINET / Industrial Ethernet applications. We are there for you at all levels of automation.

As a member of various associations and user organisations we are always at the hub of activities in this field and thus actively contribute to the further development of automation technology.

Industrial Ethernet / PROFINET



Cable characteristics:

- Flame retardant
- Weld splatter resistant
- Sunlight resistant
- Oil resistant
- Cold resistant
- Chemical resistant
- Highly flexible
- Permanent installation
- Trailing cable
- Halogen free
- Silicon free
- Compliant acc. to 2011/65/EC (RoHS 2)



Using our **product finder** you can find appropriate solutions for your application.

LEONI Special Cables with its Business Unit Automation & Drives is a member of PROFIBUS International.





www.profinet.com

and of EtherCAT Technology Group
www.ethercat.org



**Industrial Ethernet Cat 5e ES****Industrial Ethernet Cat 5e ES****Industrial Ethernet Cat 5e ES**

Application	PROFINET cable for permanent installation (easy to strip), 2x2x22AWG1, UL listed: CMG and PLTC and ITC	PROFINET cable for permanent installation (easy to strip, FRNC), 2x2x22AWG1, UL listed: CMG	PROFINET cable for permanent installation (easy to strip) with additional rodent protection, 2x2x22AWG1
Conductor	Bare copper wire $\varnothing 0.64$ mm (0.025 in), insulation of PE $\varnothing 1.5$ mm (0.059 in)	Bare copper wire $\varnothing 0.65$ mm (0.026 in), insulation of PE $\varnothing 1.5$ mm (0.059 in)	Bare copper wire $\varnothing 0.65$ mm (0.026 in), insulation of PE $\varnothing 1.5$ mm (0.059 in)
Core	Filler as central element, 4 wires twisted to a quad Inner jacket: PVC	Filler as central element, 4 wires twisted to a quad Inner jacket: FRNC	Filler as central element, 4 wires twisted to a quad Inner jacket: PVC
Shield	Alulaminat foil overlapped, shield braiding of tinned copper wires $\varnothing 0.13$ mm (0.005 in)	Alulaminat foil overlapped, shield braiding of tinned copper wires $\varnothing 0.13$ mm (0.005 in)	Alulaminat foil overlapped, shield braiding of tinned copper wires $\varnothing 0.13$ mm (0.005 in) Armouring: 2 layers of galvanised steel tape, intercalated tapes
Jacket	PVC green $\varnothing 6.5 \pm 0.2$ mm (0.256 \pm 0.008 in)	Thermoplastic copolymer (FRNC) green $\varnothing 6.5 \pm 0.2$ mm (0.256 \pm 0.008 in)	PE black $\varnothing 9.3 \pm 0.5$ mm (0.366 \pm 0.020 in)
Characteristics	Flame retardant acc. to IEC 60332-1-2 and UL 1685 (CSA FT 4), limited oil resistant, sunlight resistant acc. to UL 2556 Sec. 4.2.8.5, UL-File E119100 Vol. 1 Sec. 12 Page 1, UL-File E116441 Vol. 1 Sec. 6 Page 8, UL-File E352715 Vol. 1 Sec. 1 Page 1 verified Cat 5e, UL-File E306668 Vol. 1 Sec. 3 Page 1, UL-Style 21694 (600 V)	Flame retardant acc. to IEC 60332-3 Cat A/F, halogen free acc. to IEC 60754, sunlight resistant, UL-File E119100 Vol. 1 Sec. 11 Page 1, UL-Style 21279 (600 V)	Rodent protection, sunlight resistant, crush resistant, for direct burial, EMC resistant
Type designation	2YY(ST)CY 2x2x0.64/1.5-100 GN	2YH(ST)CH 2x2x0.64/1.5-100 GN FRNC KF25	2YY(ST)CYB2Y 2x2x0.64/1.5-100 (2B0.1VZK) BK
Order number	L45467-J16-B35	L45467-J16-B136	L45467-J16-B56

 <p>Industrial Ethernet Cat 5e ES</p>	 <p>Industrial Ethernet Cat 5e ES</p>	 <p>Industrial Ethernet Cat 5e ES</p>	
PROFINET cable for flexible installation (easy to strip), 2x2x22AWG7, UL listed: CMG and PLTC	PROFINET cable for flexible installation (easy to strip, FRNC), 2x2x22AWG7, UL listed: CMG and PLTC	PROFINET cable for flexible installation with special sunlight resistance (easy to strip), 2x2x22AWG7, UL listed: CMG and PLTC	Application
Stranded tinned copper wire 7x0.25 mm (0.010 in), Ø 0.75 mm (0.030 in), insulation of PE Ø 1.5 mm (0.059 in)	Stranded tinned copper wire 7x0.25 mm (0.010 in), Ø 0.75 mm (0.030 in), insulation of PP Ø 1.5 mm (0.059 in)	Stranded tinned copper wire 7x0.25 mm (0.010 in), Ø 0.75 mm (0.030 in), insulation of PE Ø 1.56 ± 0.03 mm (0.061 ± 0.001 in)	Conductor
Filler as central element, 4 wires twisted to a quad Inner jacket: PVC	Filler as central element, 4 wires twisted to a quad Inner jacket: FRNC	Filler as central element, 4 wires twisted to a quad Inner jacket: PVC	Core
Alulaminare foil overlapped, shield braiding of tinned copper wires Ø 0.13 mm (0.005 in)	Alulaminare foil overlapped, shield braiding of tinned copper wires Ø 0.13 mm (0.005 in)	Alulaminare foil overlapped, shield braiding of tinned copper wires Ø 0.13 mm (0.005 in)	Shield
PVC green Ø 6.5 ± 0.2 mm (0.256 ± 0.008 in)	Thermoplastic copolymer (FRNC) green Ø 6.5 ± 0.2 mm (0.256 ± 0.008 in)	PVC black Ø 6.5 ± 0.2 mm (0.256 ± 0.008 in)	Jacket
Flame retardant acc. to IEC 60332-1-2 and UL 1685 (CSA FT 4), oil resistant acc. to IEC 60811-2-1 (4 hrs, 70°C, 158°F), sunlight resistant acc. to UL 2556 Sec. 4.2.8.5, UL-File E119100 Vol. 1 Sec. 12 Page 1, UL-File E116441 Vol. 1 Sec. 6 Page 8, UL-Style 21694 (600 V)	Flame retardant acc. to IEC 60332-3 Cat A/F and UL 1685 (CSA FT 4), sunlight resistant acc. to UL 2556 Sec. 4.2.8.5, halogen free, limited oil resistance, UL-File E119100 Vol. 1 Sec. 11 Page 1, UL-File E352715 Vol. 1 Sec. 1 Page 1 verified Cat 5e, UL-File E116441 Vol. 1 Sec. 6 Page 4	Flame retardant acc. to UL 1685 (CSA FT 4), sunlight resistant acc. to UL 2556 Sec. 4.2.8.5, UL-File E119100 Vol. 1 Sec. 12 Page 1, UL-File E116441 Vol. 1 Sec. 6 Page 8, UL-Style 21695 (600 V)	Characteristics
2YY(ST)CY 2x2x0.75/1.5-100 LI GN VZN	9YH(ST)CH 2x2x0.75/1.5-100 LI VZN GN	2YY(ST)CY 2x2x0.75/1.5-100 LI VZN	Type designation
L45467-J17-B15	L45467-J16-B146	L45467-J17-B115	Order number

**Industrial Ethernet Cat 5e****Industrial Ethernet Cat 5e ES****Industrial Ethernet Cat 5e**

Application	PROFINET hybrid cable for flexible installation, (FRNC) 2x2x22AWG 7 + 4x1.5 mm ² (0.059 square in), UL recognised: AWM	PROFINET trailing cable (easy to strip, FRNC), 2x2x22AWG7, UL listed: CMX	PROFINET flexible cable for torsional stress applications (FRNC), 2x2x22AWG19, UL recognised: AWM
Conductor	Wire LIH 1.5/2.4 Stranded bare copper wire 84x0.15 mm (0.006 in), Ø 1.55 mm (0.061 in), insulation of FRNC Ø 2.4 mm (0.094 in) Wire 02YS 1x0.75/1.5 LI Stranded bare copper wire 7x0.25 mm (0.010 in), Ø 0.75 mm (0.030 in), insulation of foamed PE with skin Ø 1.5 mm (0.059 in)	Stranded tinned wire 7x0.25 mm (0.010 in), Ø 0.75 mm (0.030 in), insulation of PE Ø 1.5 mm (0.059 in)	Stranded tinned copper wire 19x0.15 mm (0.006 in), Ø 0.75 mm (0.030 in), insulation of foamed PE with skin Ø 1.5 mm (0.059 in)
Core	2 wires twisted to a pair, filler as central element, 2 screened pairs, 4 wires	Filler as central element, 4 wires twisted to a quad, inner jacket: FRNC	Filler as central element, 4 wires twisted to a quad
Shield	Datawire: Alulaminat foil overlapped, shield braiding of tinned copper wires Ø 0.1 mm (0.004 in)	Alulaminat foil overlapped, shield braiding of tinned copper wires Ø 0.13 mm (0.005 in)	Shield braiding of tinned copper wires Ø 0.13 mm (0.005 in)
Jacket	Thermoplastic copolymer (FRNC) green Ø 10.3 ± 0.3 mm (0.406 ± 0.012 in)	TPU green Ø 6.5 ± 0.2 mm (0.256 ± 0.008 in)	TPU green Ø 6.5 ± 0.2 mm (0.256 ± 0.008 in)
Characteristics	Flame retardant acc. to IEC 60332-1-2, halogen free acc. to IEC 60754, sunlight resistant acc. to UL 2556 Sec. 4.2.8.5, UL Style 21282	Flame retardant acc. to IEC 60332-1-2 and UL 2556 Sec. 9.4 (VW 1), halogen free acc. to IEC 60754, oil resistant acc. to DIN EN 60811-404 (7x24hrs / 90 °C, 194 °F), sunlight resistant acc. to UL 2556 Sec. 4.2.8.5, UL-File E119100 Vol. 1 Sec. 13 Page 1, UL-File E352715 Vol. 1 Sec. 1 Page 3 verified Cat 5e	Flame retardant acc. to IEC 60332-1-2, halogen free acc. to IEC 60754, UL-Style 21161
Type designation	02YS 2x2x0.75/1.5-100 LI(STC) FRNC LIH-Z H 4x1x1.5 GN	2YH(ST)C11Y 2x2x0.75/1.5-100 LI GN VZN FRNC	02YSC11Y 1x4x0.75/1.5-100 LI VZN FRNC GN
Order number	L45467-J116-C6	L45467-J17-B18	L45467-J17-B78

 <p>Industrial Ethernet Cat 5e</p>	 <p>Industrial Ethernet Cat 5e ES</p>	 <p>Industrial Ethernet Cat 5e ES</p>	
<p>PROFINET cable for flexible installation with insulation preservation in case of fire (FE90, FRNC), 2x2x22AWG7, UL recognised: AWM</p>	<p>PROFINET flexible cable for marine applications (easy to strip, FRNC), 2x2x22 AWG7, UL listed: CMG and PLTC</p>	<p>PROFINET cable for flexible installation in offshore applications with higher oil resistance acc. to NEK 606 (easy to strip, FRNC), 2x2x22AWG7</p>	Application
<p>Stranded tinned copper wire 7x0.25 mm (0.010 in), Ø 0.75 mm (0.030 in), insulation of PE Ø 1.56 mm (0.061 in), fire resistant tape</p>	<p>Stranded tinned copper wire 7x0.25 (0.010 in), Ø 0.75 mm (0.030 in), insulation of PP Ø 1.5 mm</p>	<p>Stranded tinned copper wire 7x0.25 (0.010 in), Ø 0.75 mm (0.030 in) insulation of PE Ø 1.5 mm</p>	Conductor
<p>4 wires twisted to a quad</p>	<p>Filler as central element, 4 wires twisted to a quad, plastic tape, overlapped Inner jacket: FRNC</p>	<p>Filler as central element, 4 wires twisted to a quad, plastic tape, overlapped Inner jacket: FRNC</p>	Core
<p>Alulminate foil overlapped, shield braiding of tinned copper wires, fire resistant tape</p>	<p>Alulminate foil overlapped, shield braiding of tinned copper wires Ø 0.13 mm (0.005 in)</p>	<p>Alulminate foil overlapped, shield braiding of tinned copper wires, coverage about 85 %</p>	Shield
<p>Thermoplastic copolymer (FRNC) black Ø 6.5 ± 0.2 mm (0.256 ± 0.008 in)</p>	<p>Thermoplastic copolymer (FRNC) green Ø 6.5 ± 0.4 mm (0.256 ± 0.016 in)</p>	<p>Thermoplastic copolymer (FRNC) green Ø 6.5 ± 0.2 mm (0.256 ± 0.008 in)</p>	Jacket
<p>Flame retardant acc. to IEC 60331-23 (90 min.), halogen free acc. to IEC 60754, UL-Style 21281 (300 V)</p>	<p>Flame retardant acc. to IEC 60332-3-22 Cat A/F, halogen free, sunlight-resistant, limited oil resistant, UL-File E119100, Vol. 1, Sec. 11, Page 1, UL-File E352715 Vol. 1 Sec. 1 Page 1 verified Cat 5e, UL-File E116441, Vol. 1, Sec. 6, Page 4</p> <p>Maritime and offshore approvals: Germanischer Lloyd, Lloyds Register of Shipping, ABS Europe, Bureau Veritas, Det Norske Veritas</p>	<p>Flame retardant acc. to IEC 60332-3-24, halogen free acc. to IEC 60754, mud resistant acc. to NEK 606, sunlight resistant</p>	Characteristics
<p>2Y(FE)(ST)C(FE)H 2x2x0.75/1.9-100 LI</p>	<p>L-9YH(ST)CH 2x2x0.34/1.5-100 GN VZN FRNC</p>	<p>2YH(ST)CH 2x2x0.75/1.5-100 LI VZN GN</p>	Type designation
<p>L45467-J17-B46</p>	<p>L45467-J16-B26</p>	<p>L45467-J16-B216</p>	Order number



**Industrial Ethernet
similar Cat 5 (FRNC)**

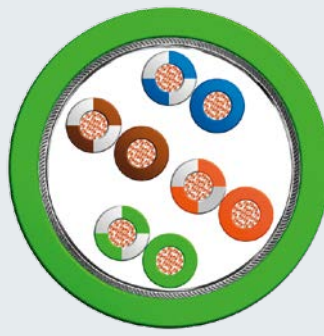

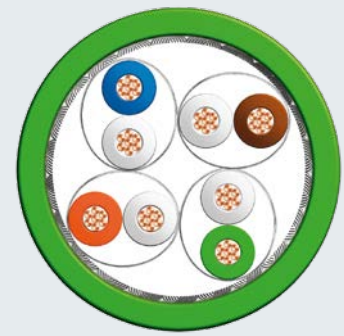

**Industrial Ethernet
similar Cat 5 (FRNC)**





Industrial Ethernet Cat 5e

Application	Trailing patch cable (FRNC), 2x2x26AWG19	Trailing patch cable (FRNC), 4x2x26AWG19, UL recognised: AWM	PROFINET Patch cable for marine applications (FRNC), 4x2x24AWG7
Conductor	Stranded bare copper wire 19x0.1 mm (0.004 in), Ø 0.5 mm (0.020 in), insulation of PP Ø 1.0 mm (0.039 in)	Stranded bare copper wire 19x0.1 mm (0.004 in), Ø 0.5 mm (0.020 in), insulation of PP Ø 1.0 mm (0.039 in)	Stranded bare copper wire 7x0.2 mm (0.008 in), Ø 0.6 mm (0.024 in), insulation of PP Ø 1.2 mm (0.047 in) 2 wires twisted to a pair
Core	Strain member out of kevlar, 4 wires twisted to a quad	2 wires twisted to a pair, 4 pairs twisted	4 pairs twisted, plastic tape overlapped
Shield	Shield braiding of tinned copper wires Ø 0.1 mm (0.004 in), plastic tape conductive	Shield braiding of tinned copper wires Ø 0.1 mm (0.004 in), plastic tape conductive	Alulminate foil overlapped, shield braiding of tinned copper wires Ø 0.13 mm (0.005 in)
Jacket	TPU green Ø 4.8 – 0.3 mm (0.189 – 0.012 in)	TPU green Ø 6.8 – 0.3 mm (0.268 – 0.012 in)	Thermoplastic copolymer (FRNC) green Ø 7.8 ± 0.3 mm (0.307 ± 0.012 in)
Characteristics	Halogen free acc. to IEC 60754, oil resistant acc. to IEC 60811-2-1, sunlight resistant	Flame retardant acc. to IEC 60332-1-2, halogen free acc. to IEC 60754, oil resistant acc. to UL 758 Sec. 15 (60 °C, 140 °F), sunlight resistant, UL-Style 20963	Flame retardant acc. to IEC 60332-3-22 Cat A, halogen free acc. to IEC 60754-2, smoke density acc. to IEC 61034, sunlight-resistant Maritime and offshore approvals: Germanischer Lloyd
Type designation	LI9YC(ST)11Y 4x1x0.15 GN	LI9YC(ST)11Y 4x2x0.15 GN	9Y(ST)CH 4x2x0.6/1.2-100 LI GN FRNC
Order number	L45581-B41-K8	L45581-B42-K8	L45467-J816-B6

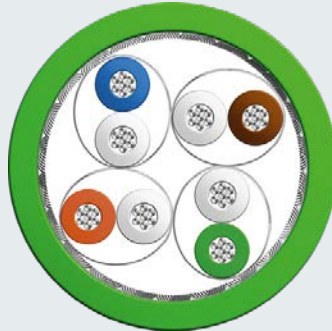
 <p>Industrial Ethernet similar Cat 5 (FRNC)</p>	 <p>Industrial Ethernet Cat 6 ES</p>	 <p>Industrial Ethernet Cat 6 ES</p>	
<p>Flexible patch cable for trailing and torsional stress applications (FRNC), 4x2x26AWG19, UL recognised: AWM</p>	<p>Cable for fixed installation (easy to strip), 4x2x24AWG1, UL listed: CMG</p>	<p>PROFINET trailing cable for flexible installation (easy to strip), 4x2x24AWG7, UL listed: CMG</p>	Application
<p>Stranded bare copper wire 19x0.1 mm (0.004 in), Ø 0.5 mm (0.020 in), insulation of PP Ø 0.95 mm (0.037 in)</p>	<p>Bare copper wire Ø 0.51 mm (0.020 in), insulation of PE Ø 1.0 mm (0.039 in) 2 wires twisted to a pair</p>	<p>Stranded bare copper wires 7x0.2 mm (0.008 in) Ø 0.6 mm (0.024 in), insulation of foamed PE with skin Ø 1.1 mm (0.043 in) 2 strands twisted to a pair</p>	Conductor
<p>2 wires twisted to a pair, 4 pairs stranded</p>	<p>4 pairs in separating element, plastic tape overlapped Inner jacket: Thermoplastic copolymer (FRNC)</p>	<p>4 pairs in separating element, plastic tape overlapped Inner jacket: Thermoplastic copolymer (FRNC)</p>	Core
<p>Aluluminum foil overlapped, wire covering</p>	<p>Aluluminum foil overlapped, applied longitudinally, shield braiding of tinned copper wires Ø 0.1 mm (0.004 in)</p>	<p>Aluluminum foil overlapped, applied longitudinally, shield braiding of tinned copper wires Ø 0.1 mm (0.004 in)</p>	Shield
<p>TPU green Ø 7.5 ± 0.2 mm (0.295 ± 0.008 in)</p>	<p>PVC green Ø 8.0 ± 0.2 mm (0.315 ± 0.008 in)</p>	<p>PVC green Ø 8.0 ± 0.2 mm (0.315 ± 0.008 in)</p>	Jacket
<p>Halogen free acc. to IEC 60754, oil resistant, UL-Style 20963</p>	<p>Flame retardant acc. to UL 1685 (CSA FT 4), sunlight-resistant acc. to UL 2556 Sec. 4.2.8.5, limited oil resistant acc. to DIN EN 50290-2-22, UL-File E119100 Vol. 1 Sec. 33 Page 1</p>	<p>Flame retardant acc. to UL 1685 (CSA FT 4) and IEC 60332-3-24 (Cat C), sunlight resistant, limited oil resistant, UL-File E119100 Vol. 1 Sec. 33 Page 1</p>	Characteristics
<p>LI9(ST)D11Y 4x2x0.15 GN</p>	<p>2YH(ST)CY 4x2x0.5/1.0-100 GN</p>	<p>02YSH(ST)CY 4x2x0.6/1.1-100 LI GN</p>	Type designation
<p>L45581-B42-K68</p>	<p>L45467-J15-B15</p>	<p>L45467-J415-C5</p>	Order number

**Industrial Ethernet Cat 6 ES****Industrial Ethernet Cat 6a****Industrial Ethernet Cat 6a ES**

Application	Trailing patch cable (easy to strip, FRNC), 4x2x26AWG19, UL listed: CMX	PROFINET cable for flexible installation, 4x2x23AWG7, UL recognised: AWM	Trailing patch cable (easy to strip, FRNC), 4x2x25AWG19, UL recognised: AW
Conductor	Stranded tinned copper wire Ø 0.55 mm (0.022 in), insulation of PP Ø 0.98 mm (0.039 in) 2 wires twisted to a pair	Stranded tinned copper wire Ø 0.72 mm (0.028 in), insulation of foamed PE with skin Ø 1.58 mm (0.062 in)	Stranded tinned copper wire Ø 0.55 mm (0.022 in), insulation of PP Ø 0.98 mm (0.039 in) 2 wires twisted to a pair
Core	4 pairs twisted, filler as central element Inner jacket: Thermoplastic copolymer (FRNC)	2 wires twisted to a pair, each pair shielded with aluminated foil, 4 pairs twisted	4 pairs in separating element, plastic tape overlapped Inner jacket: Thermoplastic copolymer (FRNC)
Shield	Aluminated foil overlapped, shield braiding of tinned copper wires Ø 0.1 mm (0.004 in)	Shield braiding of tinned copper wires, coverage 85 %	Aluminated foil overlapped, shield braiding of tinned copper wires, plastic tape overlapped
Jacket	TPU green Ø 7.8 ± 0.2 mm (0.307 ± 0.008 in)	PVC green Ø 8.7 ± 0.2 mm (0.343 ± 0.008 in)	TPU green Ø 8.8 ± 0.2 mm (0.346 ± 0.008 in)
Characteristics	Flame retardant acc. to IEC 60332-1-2, UL 2556 Sec 9.4 (VW1) and UL 1581, Sec. 1060 (CSA FT-1), halogen free acc. to IEC 60754-1, oil resistant acc. to CSA-C22.2 (4x24 hrs / 100 °C, 212 °F), UL-File E119100 Vol.1 Sec. 17 Page 1a	Flame retardant acc. to IEC 60332-1-2, sunlight resistant, limited oil resistant, UL-Style 2461	Flame retardant acc. to IEC 60332-1-2, halogen free acc. to IEC 60754-1, oil resistant acc. to DIN EN 60811-404 (7x24 hrs / 90 °C, 194 °F), UL-Style 21198
Type designation	9YH(ST)C11Y 4x2x0.55/0.98-100 LI GN	02YSCY 4x2x0.72/1.58-100 LI VZN PIMF GN	9YH(ST)C11Y 4x2x0.55/0.98-100 LI GN
Order number	L45467-J415-C48	L45467-J416-C5	L45467-J415-K28

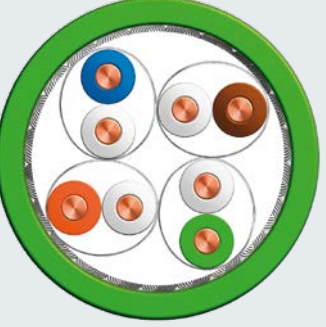
 <p>Industrial Ethernet Cat 6a ES</p>	 <p>Industrial Ethernet Cat 6a ES</p>	 <p>Industrial Ethernet Cat 7</p>	
<p>PROFINET patch cable for trailing and torsional stress applications (easy to strip, FRNC), 4x2x24AWG7, UL recognised: AWM</p>	<p>PROFINET cable for flexible installation in offshore applications with higher oil res. acc. to NEK 606 (easy to strip, FRNC), 4x2x24AWG7</p>	<p>Standard cable for permanent installation in harsh environments (FRNC), 4x2x23AWG1, UL recognised: AWM</p>	Application
<p>Stranded bare copper wire Ø 0.6 mm (0.024 in), insulation of PE Ø 1.05 mm (0.041 in), 2 wires twisted to a pair</p>	<p>Stranded bare copper wires 7x0.2 mm (0.010 in), insulation of Polyethylene (PE) Ø 1.05 mm (0.041 in), 2 strands twisted to a pair</p>	<p>Bare copper wire Ø 0.6 mm (0.024 in), insulation of foamed PE with skin Ø 1.4 mm (0.055 in)</p>	Conductor
<p>4 pairs in separating element, plastic tape overlapped</p> <p>Inner jacket: Thermoplastic copolymer (FRNC)</p>	<p>4 pairs in separating element, plastic tape, overlapped</p> <p>Inner jacket: Thermoplastic copolymer (FRNC)</p>	<p>2 wires twisted to a pair, each pair shielded with aluminated foil, 4 pairs twisted</p>	Core
<p>Aluminated foil overlapped, shield braiding of tinned copper wires, plastic tape overlapped</p>	<p>Aluminated foil overlapped, applied longitudinally, shield braiding of tinned copper wires Ø 0.1 mm (0.004 in)</p>	<p>Shield braiding of tinned copper wires Ø 0.1 mm (0.004 in)</p>	Shield
<p>TPU green Ø 8.9 ± 0.2 mm (0.350 ± 0.008 in)</p>	<p>Thermoplastic copolymer (FRNC) green Ø 8.0 ± 0.2 mm (0.315 ± 0.008 in)</p>	<p>TPU green Ø 8.2 ± 0.2 mm (0.323 ± 0.008 in)</p>	Jacket
<p>Flame retardant acc. to IEC 60332-1-2, halogen free acc. to IEC 60754-1, oil resistant acc. to DIN EN 60811-404 (7x24 hrs / 90 °C, 194 °F), UL-Style 21198</p>	<p>Flame retardant acc. to IEC 60332-3-24 (Cat C), halogen free acc. to IEC 60754, mud resistant acc. to NEK 606, sunlight resistant</p>	<p>Flame retardant acc. to IEC 60332-1-2, halogen free acc. to IEC 60754-1, oil resistant acc. to IEC 60811-2-1 (4 hrs / 70 °C, 158 °F), UL-Style 20963</p>	Characteristics
<p>2YH(ST)C11Y 4x2x0.6/1.05-100 LI GN</p>	<p>2YH(ST)CH 4x2x0.6/1.05-100 LI GN</p>	<p>02YSC11Y 4x2x0.6/1.4-100 FRNC GN PIMF</p>	Type designation
<p>L45467-J416-B28</p>	<p>L45467-J416-B16</p>	<p>L45467-J816-C38</p>	Order number

**Industrial Ethernet Cat 7****Industrial Ethernet Cat 7****Industrial Ethernet Cat 7**

Application	Cable for flexible installation in marine applications (FRNC), 4x2x22AWG7	Cable for flexible installation in marine applications with higher oil res. (FRNC), 4x2x22AWG7	Cable for flexible installation in offshore applications with higher oil res. acc. to NEK 606 (FRNC), 4x2x22AWG7
Conductor	Stranded bare copper wire 7x0.25mm (0.010 in), Ø 0.76 mm (0.03 in), insulation of foamed PE with skin Ø 1.8 mm (0.071 in)	Stranded bare copper wire 7x0.25mm (0.010 in), Ø 0.76 mm (0.03 in), insulation of foamed PE with skin Ø 1.8 mm (0.071 in)	Stranded bare copper wire 7x0.25mm (0.010 in), Ø 0.76 mm (0.03 in), insulation of foamed PE with skin Ø 1.8 mm (0.071 in)
Core	2 wires twisted to a pair, each pair shielded with alumininate foil, 4 pairs twisted	2 wires twisted to a pair, each pair shielded with alumininate foil, 4 pairs twisted	2 wires twisted to a pair, each pair shielded with alumininate foil, 4 pairs twisted
Shield	Shield braiding of tinned copper wires, coverage 65 %	Shield braiding of tinned copper wires, coverage 65 %	Shield braiding of tinned copper wires, coverage 65 %
Jacket	Thermoplastic copolymer (FRNC) black Ø 10.0 ± 0.2 mm (0.394 ± 0.008 in)	Thermoplastic copolymer (FRNC) black Ø 10.0 ± 0.2 mm (0.394 ± 0.008 in)	Thermoplastic copolymer (FRNC) black Ø 10.0 ± 0.2 mm (0.394 ± 0.008 in)
Characteristics	Flame retardant acc. to IEC 60332-1-2 and 60332-3-22 (Cat A), halogen free acc. to IEC 60754, smoke density acc. to IEC 61034, oil resistant acc. to EN 60811-2-1 (4 hrs / 70 °C, 158 °F), sunlight resistant Maritime and offshore approvals: Germanischer Lloyd, Det Norske Veritas	Flame retardant acc. to IEC 60332-1-2 and 60332-3-22 (Cat A), halogen free acc. to IEC 60754, smoke density acc. to IEC 61034, oil resistant acc. to EN 60811-2-1 (24 hrs / 100 °C, 212 °F), sunlight resistant Maritime and offshore approvals: Germanischer Lloyd, Det Norske Veritas	Flame retardant acc. to IEC 60332-1-2 and 60332-3-22 (Cat A), halogen free acc. to IEC 60754, oil resistant acc. to NEK 606, sunlight resistant Maritime and offshore approvals: Germanischer Lloyd, Det Norske Veritas
Type designation	02YSCH 4x2x0.76/1.8-100 LI PIMF	02YSCHX 4x2x0.76/1.8-100 LI PIMF	02YSCH 4x2x0.76/1.8-100 LI PIMF
Order number	L45467-J417-C6	L45467-J417-C16	L45467-J417-C26

			
Industrial Ethernet Cat 7	Industrial Ethernet Cat7	Industrial Ethernet Cat 7	
Cable for permanent installation in marine applications (FRNC), 4x2x23AWG1	Cable for permanent installation in marine applications with higher oil res. (FRNC), 4x2x23AWG1	Cable for permanent installation in offshore applications with higher oil res. acc. to NEK 606 (FRNC), 4x2x23AWG1	Application
Bare copper wire, \varnothing 0.6 mm (0.024 in), insulation of foamed PE with skin \varnothing 1.43 mm (0.056 in)	Bare copper wire, \varnothing 0.6 mm (0.024 in), insulation of foamed PE with skin \varnothing 1.43 mm (0.056 in)	Bare copper wire, \varnothing 0.6 mm (0.024 in), insulation of foamed PE with skin \varnothing 1.43 mm (0.056 in)	Conductor
2 wires twisted to a pair, each pair shielded with aluminated foil, 4 pairs twisted	2 wires twisted to a pair, each pair shielded with aluminated foil, 4 pairs twisted	2 wires twisted to a pair, each pair shielded with aluminated foil, 4 pairs twisted	Core
Shield braiding of tinned copper wires, coverage 55 %	Shield braiding of tinned copper wires, coverage 55 %	Shield braiding of tinned copper wires, coverage 55 %	Shield
Thermoplastic copolymer (FRNC) black \varnothing 8.7 \pm 0.2 mm (0.343 \pm 0.008 in)	Thermoplastic copolymer (FRNC) black \varnothing 8.7 \pm 0.2 mm (0.343 \pm 0.008 in)	Thermoplastic copolymer (FRNC) black \varnothing 8.7 \pm 0.2 mm (0.343 \pm 0.008 in)	Jacket
Flame retardant acc. to IEC 60332-1-2 and 60332-3-22 (Cat A), halogen free acc. to IEC 60754, smoke density acc. to IEC 61034, oil resistant acc. to EN 60811-2-1 (4 hrs / 70 °C, 158 °F), sunlight resistant Maritime and offshore approvals: Germanischer Lloyd, Det Norske Veritas	Flame retardant acc. to IEC 60332-1-2 and 60332-3-24 (Cat C), halogen free acc. to IEC 60754, smoke density acc. to IEC 61034, oil resistant acc. to EN 60811-2-1 (24 hrs / 100 °C, 212 °F), sunlight resistant Maritime and offshore approvals: Germanischer Lloyd, Det Norske Veritas	Flame retardant acc. to IEC 60332-1-2 and 60332-3-24 (Cat C), halogen free acc. to IEC 60754, oil resistant acc. to NEK 606, sunlight resistant Maritime and offshore approvals: Germanischer Lloyd, Det Norske Veritas	Characteristics
02YSCH 4x2x0.6/1.43-100 LI PIMF	02YSCHX 4x2x0.6/1.43-100 LI PIMF	02YSCH 4x2x0.6/1.43-100 LI PIMF	Type designation
L45467-J416-C476	L45467-J416-C96	L45467-J416-C106	Order number

**Industrial Ethernet Cat 7****Industrial Ethernet Cat 7****Industrial Ethernet Cat 7**

Application	Patch cable for flexible installation in marine applications (FRNC), 4x2x24AWG7	Patch cable for flexible installation in marine applications with higher oil res. (FRNC), 4x2x24AWG7	Patch cable for flexible installation in offshore applications with higher oil res. acc. to NEK 606 (FRNC), 4x2x24AWG7
Conductor	Stranded bare copper wire 7x0.2mm (0.008 in), Ø 0.6 mm (0.024 in), insulation of foamed PE with skin Ø 1.43 mm (0.056 in)	Stranded bare copper wire 7x0.2mm (0.008 in), Ø 0.6 mm (0.024 in), insulation of foamed PE with skin Ø 1.43 mm (0.056 in)	Stranded bare copper wire 7x0.2mm (0.008 in), Ø 0.6 mm (0.024 in), insulation of foamed PE with skin Ø 1.43 mm (0.056 in)
Core	2 wires twisted to a pair, each pair shielded with alumininate foil, 4 pairs twisted	2 wires twisted to a pair, each pair shielded with alumininate foil, 4 pairs twisted	2 wires twisted to a pair, each pair shielded with alumininate foil, 4 pairs twisted
Shield	Shield braiding of tinned copper wires, coverage 60 %	Shield braiding of tinned copper wires, coverage 60 %	Shield braiding of tinned copper wires, coverage 60 %
Jacket	Thermoplastic copolymer (FRNC) black Ø 8.7 ± 0.2 mm (0.343 ± 0.008 in)	Thermoplastic copolymer (FRNC) black Ø 8.7 ± 0.2 mm (0.343 ± 0.008 in)	Thermoplastic copolymer (FRNC) black Ø 8.7 ± 0.2 mm (0.343 ± 0.008 in)
Characteristics	Flame retardant acc. to IEC 60332-1-2 and 60332-3-22 (Cat A), halogen free acc. to IEC 60754, smoke density acc. to IEC 61034, oil resistant acc. to EN 60811-2-1 (4 hrs / 70 °C, 158 °F), sunlight resistant Maritime and offshore approvals: Germanischer Lloyd, Det Norske Veritas	Flame retardant acc. to IEC 60332-1-2 and 60332-3-24 (Cat C), halogen free acc. to IEC 60754, smoke density acc. to IEC 61034, oil resistant acc. to EN 60811-2-1 (24 hrs / 100 °C, 212 °F), sunlight resistant Maritime and offshore approvals: Germanischer Lloyd, Det Norske Veritas	Flame retardant acc. to IEC 60332-1-2 and 60332-3-24 (Cat C), halogen free acc. to IEC 60754, oil resistant acc. to NEK 606, sunlight resistant Maritime and offshore approvals: Germanischer Lloyd, Det Norske Veritas
Type designation	02YSCH 4x2x0.6/1.4-100 LI PIMF	02YSCHX 4x2x0.6/1.4-100 LI PIMF	02YSCH 4x2x0.6/1.4-100 LI PIMF
Order number	L45467-J416-C16	L45467-J416-C26	L45467-J416-C36

			
Industrial Ethernet Cat 7	Industrial Ethernet Cat7	Industrial Ethernet Cat 7	
Patch cable for flexible installation in marine applications (FRNC), 4x2x26AWG7	Patch cable for flexible installation in marine applications with higher oil res. (FRNC), 4x2x26AWG7	Patch cable for flexible installation in offshore applications with higher oil res. acc. to NEK 606 (FRNC), 4x2x26AWG7	Application
Stranded bare copper wire 7x0.16mm (0.008 in), Ø 0.48 mm (0.019 in), insulation of foamed PE with skin Ø 1.0 mm (0.039 in)	Stranded bare copper wire 7x0.16mm (0.008 in), Ø 0.48 mm (0.019 in), insulation of foamed PE with skin Ø 1.0 mm (0.039 in)	Stranded bare copper wire 7x0.16mm (0.008 in), Ø 0.48 mm (0.019 in), insulation of foamed PE with skin Ø 1.0 mm (0.039 in)	Conductor
2 wires twisted to a pair, each pair shielded with aluminated foil, 4 pairs twisted	2 wires twisted to a pair, each pair shielded with aluminated foil, 4 pairs twisted	2 wires twisted to a pair, each pair shielded with aluminated foil, 4 pairs twisted	Core
Shield braiding of tinned copper wires, coverage 65 %	Shield braiding of tinned copper wires, coverage 65 %	Shield braiding of tinned copper wires, coverage 65 %	Shield
Thermoplastic copolymer (FRNC) black Ø 7.1 ± 0.2 mm (0.280 ± 0.008 in)	Thermoplastic copolymer (FRNC) black Ø 7.1 ± 0.2 mm (0.280 ± 0.008 in)	Thermoplastic copolymer (FRNC) black Ø 7.1 ± 0.2 mm (0.280 ± 0.008 in)	Jacket
Flame retardant acc. to IEC 60332-1-2 and 60332-3-22 (Cat A), halogen free acc. to IEC 60754, smoke density acc. to IEC 61034, oil resistant acc. to EN 60811-2-1 (4 hrs / 70 °C, 158 °F), sunlight resistant Maritime and offshore approvals: Germanischer Lloyd, Det Norske Veritas	Flame retardant acc. to IEC 60332-1-2 and 60332-3-22 (Cat A), halogen free acc. to IEC 60754, smoke density acc. to IEC 61034, oil resistant acc. to EN 60811-2-1 (24 hrs / 100 °C, 212 °F), sunlight resistant Maritime and offshore approvals: Germanischer Lloyd, Det Norske Veritas	Flame retardant acc. to IEC 60332-1-2 and 60332-3-24 (Cat C), halogen free acc. to IEC 60754, oil resistant acc. to NEK 606, sunlight resistant Maritime and offshore approvals: Germanischer Lloyd, Det Norske Veritas	Characteristics
02YSCH 4x2x0.5/1.0-100 LI PIMF	02YSCHX 4x2x0.5/1.0-100 LI PIMF	02YSCH 4x2x0.5/1.0-100 LI PIMF	Type designation
L45467-J415-C246	L45467-J415-C256	L45467-J415-C266	Order number

PROFIBUS

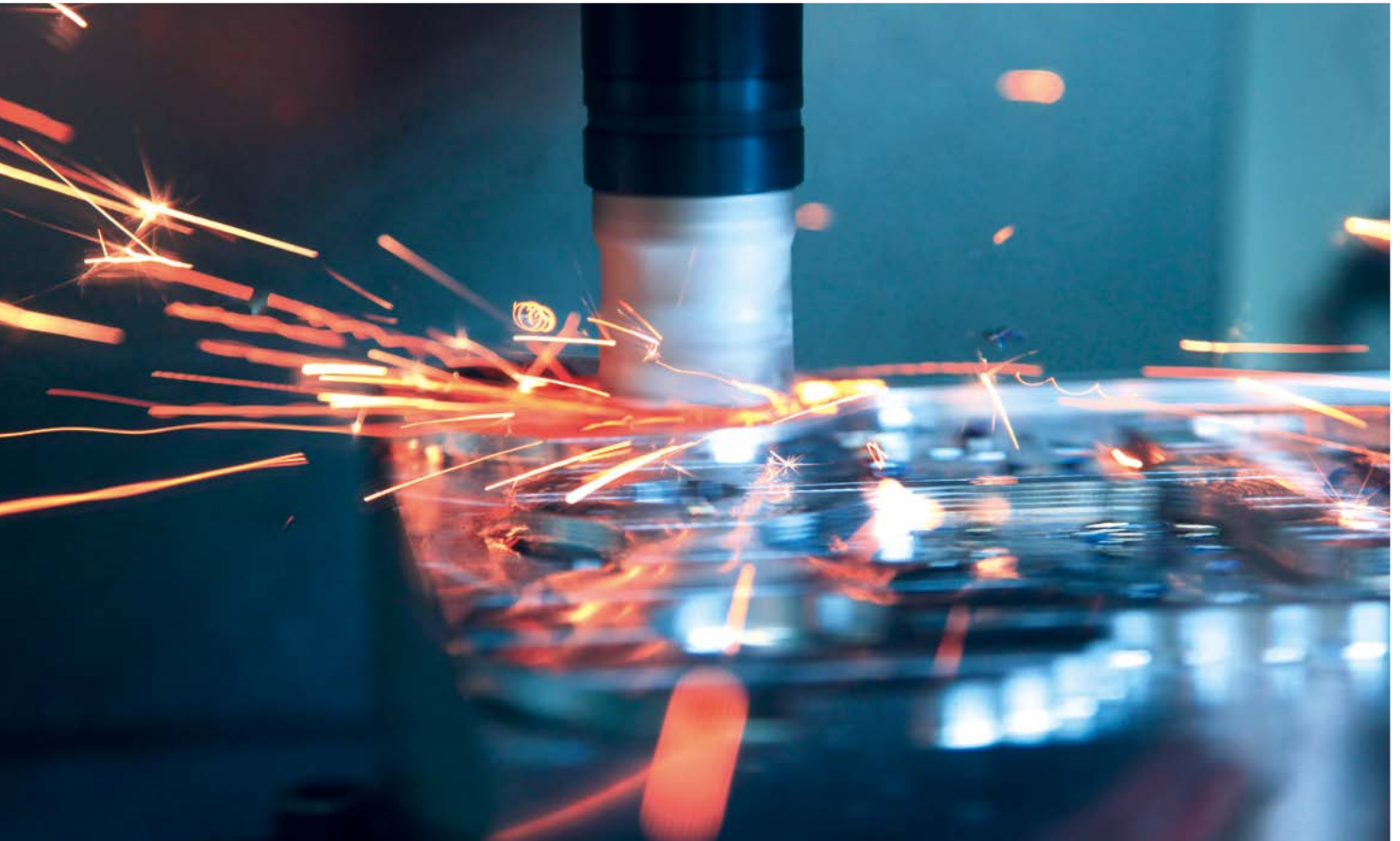

Cable characteristics:

- Flame retardant
- Weld splatter resistant
- Sunlight resistant
- Oil resistant
- Cold resistant
- Chemical resistant
- Insulation integrity (90 min)
- Highly flexible
- Permanent installation
- Direct burial
- Festoon cable
- Torsional stress cable
- Trailing cable
- Halogen free
- Silicon free
- EMC cable for electro-magnetic compatibility
- Compliant acc. to 2011/65/EC (RoHS 2)



Using our **product finder** you can find appropriate solutions for your application.

LEONI Special Cables with its Business Unit Automation & Drives is a member of PROFIBUS International.



www.profibus.com

			
PROFIBUS DP ES	PROFIBUS DP ES	PROFIBUS DP ES	
Cable for permanent installation (easy to strip), 2x22AWG1, UL listed: CMG and CL3	Cable for permanent installation (easy to strip, FRNC), 2x22AWG1, UL listed: CM	Cable for permanent installation in harsh environments (easy to strip), 2x22AWG1, UL listed: CMX	Application
Bare copper wire Ø 0.64 mm (0.025 in), insulation of foamed PE with skin Ø 2.55 mm (0.100 in)	Bare copper wire Ø 0.64 mm (0.025 in), insulation of foamed PE with skin Ø 2.55 mm (0.100 in)	Bare copper wire Ø 0.64 mm (0.025 in), insulation of foamed PE with skin Ø 2.55 mm (0.100 in)	Conductor
2 wires twisted to a pair Inner jacket: PVC	2 wires twisted to a pair Inner jacket: FRNC	2 wires twisted to a pair Inner jacket: PVC	Core
Alulaminat foil overlapped, shield braiding of tinned copper wires Ø 0.15 mm (0.06 in)	Alulaminat foil overlapped, shield braiding of tinned copper wires Ø 0.15 mm (0.06 in)	Alulaminat foil overlapped, shield braiding of tinned	Shield
PVC violet Ø 8.0 ± 0.4 mm (0.315 ± 0.016 in)	Thermoplastic copolymer (FRNC) violet Ø 8.0 ± 0.4 mm (0.315 ± 0.016 in)	TPU violet Ø 8.0 ± 0.4 mm (0.315 ± 0.016 in)	Jacket
Flame retardant acc. to IEC 60332-3-24 and UL 1685 (CSA FT 4), cold bending resistant acc. to IEC 60811-1-4, sunlight resistant acc. to UL 2556 Sec. 4.2.8.5, UL-File E119100 Vol. 1 Sec. 16 Page 7, UL-File E116441 Vol. 1 Sec. 6 Page 7, UL-Style 21694 (600 V)	Flame retardant acc. to IEC 60332-3-24 and UL 1685 Sec. 1160 (Vertical Tray), halogen free acc. to IEC 60754, sunlight resistant acc. to UL 2556 Sec. 4.2.8.5, limited oil resistant, UL-File E119100 Vol. 1 Sec. 11 Page 1	Flame retardant acc. to IEC 60332-1-2, cold bending resistant acc. to IEC 60811-1-4, sunlight resistant, mineral oil and fat resistant, oil resistant acc. to UL 2556 Sec. 4.2.8.3, UL-File E119100 Vol. 1 Sec. 8 Page 1	Characteristics
02YSY(ST)CY 1x2x0.64/2.55-150 VI KF40 FR	02YSH(ST)CH 1x2x0.64/2.55-150 VI KF25 FRN	02YSY(ST)C11Y 1x2x0.64/2.55-150 VI KF40 FR	Type designation
L45467-G16-C185	L45467-G16-C286	L45467-G16-C118	Order number

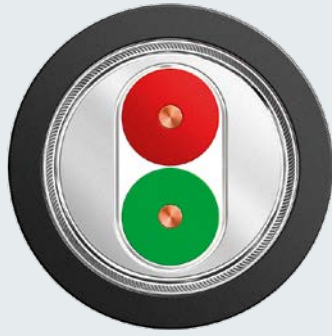
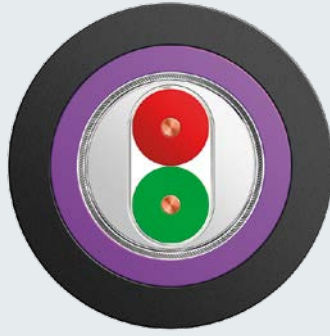
**PROFIBUS DP ES****PROFIBUS DP ES****PROFIBUS DP ES**

Application	Cable for food industry (easy to strip), 2x22AWG1	Cable for direct burial (easy to strip), 2x22AWG1	Trailing cable (easy to strip), similar to 2x23AWG19, UL listed: CMX
Conductor	Bare copper wire Ø 0.64 mm (0.025 in), insulation of foamed PE with skin Ø 2.55 mm (0.100 in)	Bare copper wire Ø 0.64 mm (0.025 in), insulation of foamed PE with skin Ø 2.55 mm (0.100 in)	Stranded bare copper wire 19x0.14 mm (0.006 in), Ø 0.65 mm (0.026 in), insulation of foamed PE Ø 2.56 mm (0.101 in)
Core	2 wires twisted to a pair Inner jacket: PVC	2 wires twisted to a pair Inner jacket: PVC	2 wires twisted to a pair Inner jacket: PVC
Shield	Alulminate foil overlapped, shield braiding of tinned copper wires Ø 0.15 mm (0.006 in)	Alulminate foil overlapped, shield braiding of tinned copper wires Ø 0.15 mm (0.006 in)	Alulminate foil overlapped, shield braiding of tinned copper wires Ø 0.15 mm (0.006 in)
Jacket	PE black Ø 8.0 ± 0.4 mm (0.315 ± 0.016 in)	Inner jacket: PVC violet Ø 8.0 ± 0.4 mm (0.315 ± 0.016 in) Outer jacket: PE black Ø 10.8 ± 0.5 mm (0.425 ± 0.020 in)	TPU petrol Ø 8.0 ± 0.4 mm (0.315 ± 0.016 in)
Characteristics	Cold bending resistant acc. to IEC 60811-1-4, sunlight resistant, limited mineral oil and fat resistant	Cold bending resistant acc. to IEC 60811-1-4, sunlight resistant, limited mineral oil and fat resistant	Flame retardant acc. to IEC 60332-1-2, cold bending resistant acc. to IEC 60811-1-4, mineral oil and fat resistant, oil resistant acc. to UL 13 Sec. 40 (60°C, 140°F), oil resistant acc. to UL 2556 Sec. 4.2.8.3, UL-File E119100 Vol. 1 Sec. 8 Page 1
Type designation	02YSY(ST)C2Y 1x2x0.64/2.55-150 KF40 BK	02YSY(ST)CY2Y 1x2x0.64/2.55-150 KF40 BK	02YY(ST)C11Y 1x2x0.65/2.56-150 LI KF40 FR petrol
Order number	L45467-G16-C246	L45467-G16-C236	L45467-G16-C98

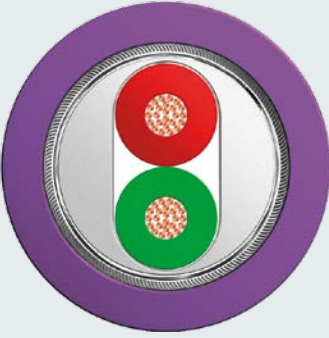
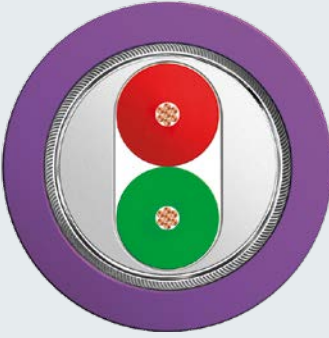
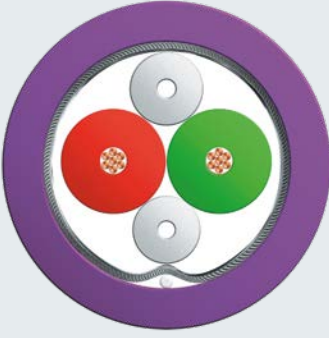
 <p>PROFIBUS DP ES</p>	 <p>PROFIBUS DP ES</p>	 <p>PROFIBUS DP ES</p>	
<p>Cable for flexible installation (easy to strip), similar to 2x23AWG19, UL listed: CMG and CL3</p>	<p>Cable for flexible installation in marine applications (easy to strip, FRNC), 2x22AWG7 [a] SHF 1 [b] SHF 2, with higher oil resistant</p>	<p>Cable for flexible installation in offshore applications with higher oil res. acc. to NEK 606 (easy to strip, FRNC), 2x22AWG7</p>	Application
<p>Stranded bare copper wire 19x0.14 mm (0.006 in), Ø 0.67 mm (0.026 in), insulation of foamed PE with skin Ø 2.56 mm (0.101 in)</p>	<p>Stranded bare copper wire Ø 0.76 mm (0.030 in), insulation of foamed PE with skin Ø 2.55 mm (0.100 in)</p>	<p>Stranded bare copper wire Ø 0.76 mm (0.030 in), insulation of foamed PE with skin Ø 2.55 mm (0.100 in)</p>	Conductor
<p>2 wires twisted to a pair Inner jacket: PVC</p>	<p>2 wires twisted to a pair, plastic tape overlapped Inner jacket: FRNC</p>	<p>2 wires twisted to a pair, plastic tape overlapped Inner jacket: FRNC</p>	Core
<p>Alulaminat foil overlapped, shield braiding of tinned copper wires Ø 0.15 mm (0.006 in)</p>	<p>Alulaminat foil overlapped, applied longitudinally, shield braiding of tinned copper wires Ø 0.15 mm (0.006 in)</p>	<p>Alulaminat foil overlapped, applied longitudinally, shield braiding of tinned copper wires Ø 0.15 mm (0.006 in)</p>	Shield
<p>PVC violet Ø 8.0 ± 0.4 mm (0.315 ± 0.016 in)</p>	<p>Thermoplastic copolymer (FRNC) violet Ø 8.0 ± 0.4 mm (0.315 ± 0.016 in)</p>	<p>Thermoplastic copolymer (FRNC) violet Ø 8.0 ± 0.4 mm (0.315 ± 0.016 in)</p>	Jacket
<p>Flame retardant acc. to IEC 60332-3-24 and UL 1685 (CSA FT 4), cold bending resistant acc. to DIN VDE 50290-2-22, sunlight resistant acc. to UL 2556 Sec. 4.2.8.5, UL-File E119100 Vol. 1 Sec. 16 Page 7, UL-File E116441 Vol. 1 Sec. 6 Page 7, UL-Style 21694 (600 V)</p>	<p>Flame retardant acc. to IEC 60332-1-2 and 60332-3-22 (Cat A/F), halogen free acc. to IEC 60754, smoke density acc. to IEC 61034, oil resistant acc. to EN 60811-2-1 (SHF1: 4 hrs/70 °C, 158 °F, SHF2: 24 hrs/100 °C, 212 °F), sunlight resistant</p> <p>Maritime and offshore approvals: Germanischer Lloyd, Lloyds Register of Shipping, ABS Europe, Bureau Veritas, Det Norske Veritas</p>	<p>Flame retardant acc. to IEC 60332-3-22 (Cat A), halogen free acc. to IEC 60754, mud resistant acc. to NEK 606, sunlight resistant</p>	Characteristics
<p>02YSY(ST)CY 1x2x0.65/2.55-150 LI VI</p>	<p>[a] 02YSH(ST)CH 1x2x0.75/2.55-150 LI VI FRNC [b] 02YSH(ST)CHX 1x2x0.75/2.55-150 LI VI FRNC</p>	<p>02YSH(ST)CH 1x2x0.75/2.55-150 LI VI</p>	Type designation
<p>L45467-G16-C375</p>	<p>[a] L45467-G17-C46 [b] L45467-G17-C56</p>	<p>L45467-G17-C106</p>	Order number

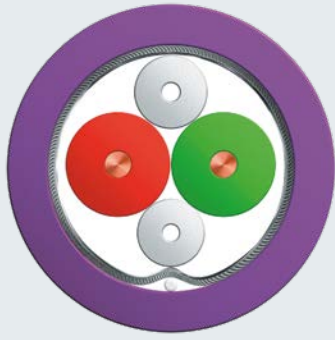
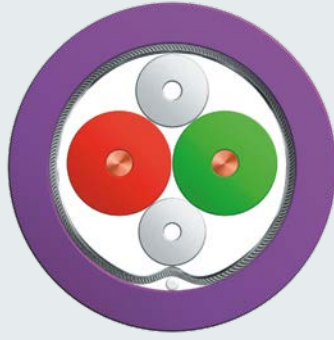
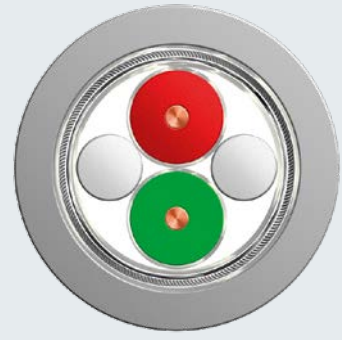

**PROFIBUS DP ES****PROFIBUS DP****PROFIBUS DP**

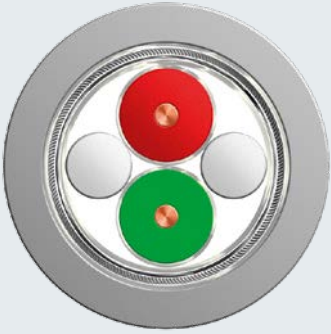
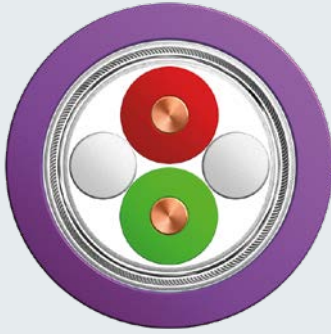
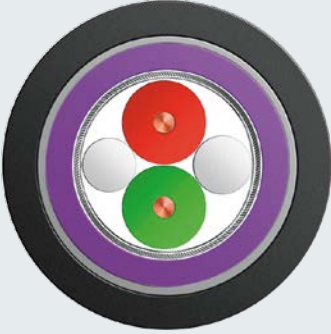
Application	Cable for permanent installation, 2x22AWG1, UL listed: CMG and PLTC	Cable for permanent installation (FRNC), 2x22AWG1	Cable for permanent installation with 90 minutes insulation integrity under fire conditions (FE90, FRNC), 2x22AWG1
Conductor	Bare copper wire Ø 0.64 mm (0.025 in), insulation of foamed PE with skin Ø 2.55 mm (0.100 in)	Bare copper wire Ø 0.64 mm (0.025 in), insulation of foamed PE with skin Ø 2.55 mm (0.100 in)	Bare copper wire Ø 0.64 mm (0.025 in), insulation of foamed PE with skin Ø 2.55 mm (0.100 in), flame protection foil overlapped Ø 2.75 mm (0.108 in)
Core	2 wires twisted to a pair with fillers in gaps	2 wires twisted to a pair with fillers in gap	2 wires twisted to a pair with fillers in gaps
Shield	Alulminate foil overlapped, shield braiding of tinned copper wires Ø 0.15 mm (0.006 in)	Alulminate foil overlapped, shield braiding of tinned copper wires Ø 0.15 mm (0.006 in)	Alulminate foil overlapped, shield braiding of tinned copper wires Ø 0.15 mm (0.006 in), flame protection foil overlapped
Jacket	PVC violet Ø 8.0 ± 0.4 mm (0.315 ± 0.016 in)	Thermoplastic copolymer (FRNC) violet Ø 8.0 ± 0.4 mm (0.315 ± 0.016 in)	Thermoplastic copolymer (FRNC) grey Ø 8.8 ± 0.4 mm (0.346 ± 0.016 in)
Characteristics	Flame retardant acc. to IEC 60332-3-24 and UL 1685 (CSA FT 4), cold bending resistant acc. to IEC 60811-1-4, sunlight resistant acc. to UL 2556 Sec. 4.2.8.5, limited oil and fat resistant, UL-File E119100 Vol. 1 Sec. 16 Page 7, UL-File E116441 Vol. 1 Sec. 6 Page 7, UL-Style 21694 (600 V)	Flame retardant acc. to IEC 60332-3-24, halogen free acc. to IEC 60754, smoke density acc. to IEC 61034, sunlight resistant acc. to UL 2556 Sec. 4.2.8.5	Insulation effect under fire conditions acc. to IEC 60331-21, halogen free
Type designation	02YS(ST)CY 1x2x0.64/2.55-150 VI KF40 FR	02Y(ST)CH 1x2x0.64/2.55-150 VI FRNC KF25	02YS(ST)CH 1x2x0.64/2.55-150 GR FRNC FE 90
Order number	L45467-G16-C145	L45467-G16-C206	L45467-G16-C266

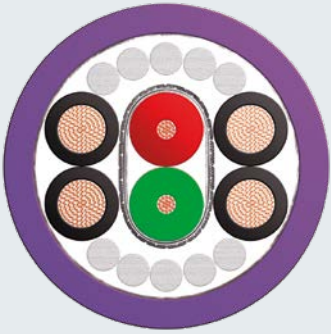

			
PROFIBUS DP	PROFIBUS DP	PROFIBUS DP	
Cable for permanent installation with 180 minutes insulation integrity under fire conditions (FE180, FRNC), 2x22AWG1	High temperature cable for permanent installation, 2x22AWG1	Cable for permanent installation with rodent protection, 2x22AWG1	Application
Bare copper wire Ø 0.64 mm (0.025 in), insulation of foamed PE with skin Ø 2.55 mm (0.100 in), flame protection foil overlapped Ø 2.75 mm (0.108 in)	Bare copper wire Ø 0.64 mm (0.025 in), insulation of foamed FEP Ø 2.55 mm (0.100 in)	Bare copper wire Ø 0.64 mm (0.025 in), insulation of foamed PE with skin Ø 2.55 mm (0.100 in)	Conductor
2 wires twisted to a pair with fillers in gaps	2 wires twisted to a pair with fillers in gaps	2 wires twisted to a pair with fillers in gaps	Core
Alulminate foil overlapped, shield braiding of tinned copper wires Ø 0.15 mm (0.006 in), flame protection foil overlapped	Alulminate foil overlapped, shield braiding of tinned copper wires Ø 0.15 mm (0.006 in)	Alulminate foil overlapped, shield braiding of tinned copper wires Ø 0.15 mm (0.006 in) Inner jacket: PVC violet, Ø 8.0 ± 0.4 mm (0.315 ± 0.016 in) Armouring: 2 layers galvanised steel tape, intercalated tapes	Shield
Thermoplastic copolymer (FRNC) grey Ø 8.8 ± 0.4 mm (0.346 ± 0.016 in)	FEP violet Ø 7.2 ± 0.25 mm (0.283 ± 0.010 in)	PE black Ø 10.8 ± 0.5 mm (0.425 ± 0.020 in)	Jacket
Insulation effect under fire conditions acc. to IEC 60331-23, halogen free	High temperature range (up to 180 °C, 356 °F), oil resistant, sunlight resistant	Sunlight resistant, limited mineral oil and fat resistant	Characteristics
02YS(ST)CH 1x2x0.64/2.55-150 GR FRNC FE 180	06Y(ST)C6Y 1x2x0.64/2.55-150 VI	02YS(ST)CYB2Y 1x2x0.64/2.55-150 (2B0.1VZK)	Type designation
L45467-G16-C436	L45467-G16-N17	L45467-G16-C276	Order number

**PROFIBUS DP****PROFIBUS DP****PROFIBUS DP**

Application	EMC cable for permanent installation indoor or outdoor with high electromagnetic compatibility and weld splatter resistant, 2x22AWG1	Trailing cable (FRNC), similar to 2x23AWG19, UL listed: CMX	Festoon cable, similar to 2x23AWG19, UL listed: CM and CL3
Conductor	Bare copper wire Ø 0.64 mm (0.025 in), insulation of foamed PE with skin Ø 2.55 mm (0.100 in)	Stranded bare copper wire 19x0.14 mm (0.006 in), Ø 0.64 mm (0.025 in), insulation of foamed PE with skin Ø 2.55 mm (0.100 in)	Stranded bare copper wire 19x0.14 mm (0.006 in), Ø 0.65 mm (0.026 in), insulation of foamed PE with skin Ø 2.56 mm (0.101 in)
Core	2 wires twisted to a pair with fillers in gaps, tinned copper drain wire	2 wires twisted to a pair with fillers in gaps	2 wires twisted to a pair with fillers in gaps
Shield	Alulaminat foil overlapped, copper tape longitudinal welded and spiral corrugated	Alulaminat foil overlapped, shield braiding of tinned copper wires Ø 0.15 mm (0.006 in)	Alulaminat foil overlapped, shield braiding of tinned copper wires Ø 0.1 mm (0.004 in)
Jacket	PVC violet Ø 11.1 ± 0.3 mm (0.437 ± 0.012 in)	TPU petrol Ø 8.5 ± 0.4 mm (0.335 ± 0.016 in)	Polyvinylchloride (PVC) petrol Ø 8.0 ± 0.3 mm (0.315 ± 0.012 in)
Characteristics	Flame retardant acc. to IEC 60332-1-2, sunlight resistant	Flame retardant acc. to IEC 60332-1-2, halogen free acc. to IEC 60754, smoke density acc. to IEC 61034, oil resistant acc. to UL 13 Sec. 40 (60 °C, 140 °F), sunlight resistant acc. to UL 2556 Sec. 4.2.8.5, UL-File E119100 Vol. 1 Sec. 8 Page 1	Flame retardant acc. to UL 1685 (Vertical tray), oil resistant acc. to UL 758 Sec. 15 (60 °C, 140 °F), sunlight resistant acc. to UL 1581 Sec. 1200, UL-File E119100 Vol. 1 Sec. 16 Page 6, UL-File E116441 Vol. 1 Sec. 6 Page 6, UL-Style 21694 (600 V)
Type designation	02YS(ST)WKY 1x2x0.64/2.55-150 VI KF40 FR	02YS(ST)C11Y 1x2x0.64/2.55-150 LI FRNC petrol	02YS(ST)CY 1x2x0.65/2.56 -150 LI petrol FR
Order number	L45467-G16-C355	L45467-G16-C88	L45467-G16-C555

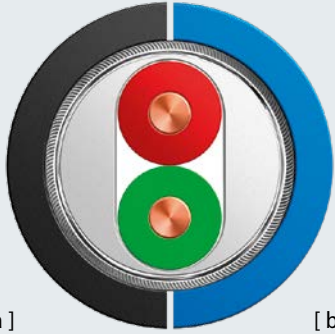
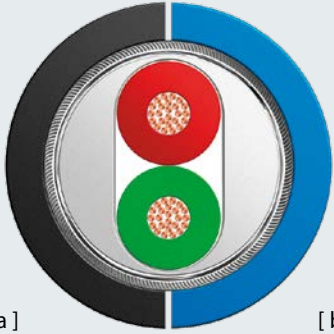
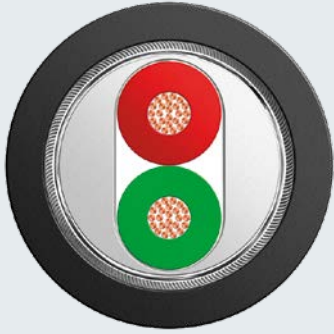
 <p>PROFIBUS DP</p>	 <p>PROFIBUS DP-Desina</p>	 <p>PROFIBUS DP-ET 200X</p>	
Flexible cable for torsional stress applications (FRNC), 2x22AWG19, UL listed: CMX	Hybrid cable for trailing applications (FRNC), 2x23AWG19 + 4x1.5mm ² (0.059 square in), UL recognised: AWM	Hybrid cable for trailing application, 2x22AWG19 + 3x0.75mm ² (0.030 square in), UL recognised: AWM	Application
Stranded bare copper wire 19x0.16 mm (0.006 in), Ø 0.8 mm (0.031 in), insulation of foamed PE with skin Ø 2.56 mm (0.101 in)	<p>Wire LIH 1.5/2.4 Stranded bare copper wire 84x0.15 mm (0.006 in), Ø 1.55 mm (0.061 in), insulation of FRNC Ø 2.4 mm (0.094 in)</p> <p>Wire 02Y 0.65/2.56 LI Stranded bare copper wire 19x0.14 mm (0.006 in), Ø 0.65 mm (0.256 in), insulation of foamed PE Ø 2.56 mm (0.101 in)</p> <p>Screened pair 02Y(ST)C 2 wires twisted to a pair, alulaminare foil overlapped, shield braiding of tinned copper wires Ø 0.15 mm (0.006 in)</p>	<p>Wire LIY 0.75/1.7 Stranded bare copper wire 24x0.2 mm (0.008 in), Ø 1.15 mm (0.045 in), insulation of PVC Ø 1.7 mm (0.067 in)</p> <p>Wire 02Y 0.65/2.56 LI Stranded bare copper wire 19x0.13 mm (0.005 in), Ø 0.65 mm (0.256 in), insulation of foamed PE Ø 2.56 mm (0.101 in)</p> <p>Screened pair 02Y(ST)C 2 wires twisted to a pair, alulaminare foil overlapped, shield braiding of tinned copper wires Ø 0.15 mm (0.006 in)</p>	Conductor
2 wires twisted to a pair with fillers in gaps	1 screened pair, 4 wires	1 pair twisted, 3 wires	Core
2 layers of plastic tape conductive, shield braiding of tinned copper wires Ø 0.15 mm (0.006 in)			Shield
TPU violet Ø 8.0 ± 0.4 mm (0.315 ± 0.016 in)	TPU violet Ø 11.0 ± 0.3 mm (0.433 ± 0.012 in)	TPU petrol, Ø 9.5 ± 0.5 mm (0.374 ± 0.020 in)	Jacket
Flame retardant acc. to IEC 60332-1-2, halogen free acc. to IEC 60754, sunlight resistant, oil resistant acc. to UL 13 Sec. 40 (60 °C, 140 °F), UL-File E119100 Vol. 1 Sec. 8 Page 1	Flame retardant acc. to IEC 60332-1-2, halogen free acc. to IEC 60754, oil resistant acc. to UL 758 Sec. 15 (60 °C, 140 °F), sunlight resistant acc. to UL 2556 Sec. 4.2.8.5, UL-Style 21198	Flame retardant acc. to IEC 60332-1-2, oil resistant acc. to IEC 60811-2-1 (4h, 70 °C, 158 °F), UL-Style 20351	Characteristics
02YS(ST)C11Y 1x2x0.8/2.56-150 LI FR VI	02Y(ST)C 1x2x0.65/2.56-150 LI LIH-Z 11Y 4x1x1.5 VI FRNC	02Y(ST)C 1x2x0.65/2.56-150 LI LIY-J 11Y 3x1x0.75 petrol	Type designation
L45467-G18-C18	L45467-G116-W58	L45467-G116-W38	Order number

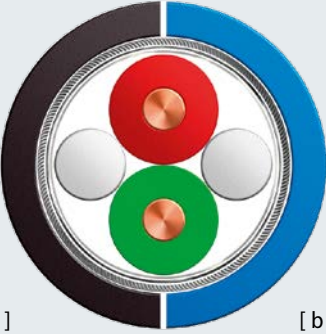
	 <p>[a]</p>	 <p>[b]</p>	
	PROFIBUS PA ES	PROFIBUS PA ES	PROFIBUS PA ES
Application	<p>Cable for permanent installation</p> <p>[a] (easy to strip), 2x18AWG1, UL listed: CM and CL3</p> <p>[b] in hazardous Ex-areas (easy to strip), 2x18AWG1, UL listed: CM and CL3</p>	<p>Cable for flexible installation</p> <p>[a] standard (easy to strip)</p> <p>[b] in hazardous Ex-areas (easy to strip) 2x18AWG19, UL recognised: AWM</p>	<p>Cable for flexible installation (easy to strip, FRNC), 2x18AWG7, UL listed: CM</p>
Conductor	<p>Bare copper wire \varnothing 1.05 mm (0.041 in), insulation of foamed PE with skin \varnothing 2.55 mm (0.100 in)</p>	<p>Stranded bare copper wire 19x0.26 mm (0.010 in), \varnothing 1.3 mm (0.049 in), insulation of foamed PE with skin \varnothing 2.55 mm (0.100 in)</p>	<p>Stranded bare copper wire 7x0.4 mm (0.016 in), \varnothing 1.2 mm (0.047 in), insulation of foamed PE with skin \varnothing 2.55 mm (0.100 in)</p>
Core	<p>2 wires twisted to a pair</p> <p>Inner jacket: PVC</p>	<p>2 wires twisted to a pair</p> <p>Inner jacket: PVC</p>	<p>2 wires twisted to a pair</p> <p>Inner jacket: FRNC</p>
Shield	<p>Alulminate foil overlapped, shield braiding of tinned copper wires \varnothing 0.15 mm (0.006 in)</p>	<p>Shield braiding of tinned copper wires \varnothing 0.15 mm (0.006 in)</p>	<p>Alulminate foil overlapped, shield braiding of tinned copper wires \varnothing 0.15 mm (0.006 in)</p>
Jacket	<p>[a] PVC black \varnothing 8.0 \pm 0.4 mm (0.315 \pm 0.016 in)</p> <p>[b] PVC blue \varnothing 8.0 \pm 0.4 mm (0.315 \pm 0.016 in)</p>	<p>[a] PVC black \varnothing 8.0 \pm 0.3 mm (0.315 \pm 0.012 in)</p> <p>[b] PVC blue \varnothing 8.0 \pm 0.3 mm (0.315 \pm 0.012 in)</p>	<p>Thermoplastic copolymer (FRNC) black \varnothing 8.0 \pm 0.2 mm (0.315 \pm 0.008 in)</p>
Characteristics	<p>Flame retardant acc. to UL 1685 (Vertical tray), oil resistant acc. to UL 758 Sec. 15 (60°C, 140°F), sunlight resistant acc. to UL 1581 Sec. 1200, UL-File E119100 Vol. 1 Sec.16 Page 6, UL-File E116441 Vol. 1 Sec. 6 Page 6, UL-Style 21694</p>	<p>Flame retardant acc. to IEC 60332-1-2, UL-Style 2905</p>	<p>Flame retardant acc. to IEC 60332-3-24, halogen free acc. to IEC 60754, smoke density acc. to IEC 61034, sunlight resistant acc. to UL 2556 Sec. 4.2.8.5, UL-File E119100 Vol. 1 Sec. 16 Page 5</p>
Type designation	<p>[a] 02YSY(ST)CY 1x2x1.0/2.55-100 OE FR</p> <p>[b] 02YSY(ST)CY 1x2x1.0/2.55-100 BL OE FR</p>	<p>[a] 02YSYCY 1x2x1.3/2.55-100 LI BK FR KF40</p> <p>[b] 02YSYCY 1x2x1.3/2.55-100 LI BL FR KF40</p>	<p>02YSH(ST)CH 1x2x1.2/2.55-100 BK LI FRNC</p>
Order number	<p>[a] L45467-J20-C225</p> <p>[b] L45467-J20-C275</p>	<p>[a] L45467-J21-C45</p> <p>[b] L45467-J21-C35</p>	<p>L45467-J20-C6</p>

 [a]	 [b]		
PROFIBUS PA Cable for permanent installation in hazardous Ex-areas 2x18AWG 1, UL listed: CMX	PROFIBUS PA EMC cable for permanent installation indoor or outdoor or in hazardous Ex-areas with high electromagnetic compatibility and weld splatter resistance, 2x18AWG1	PROFIBUS PA ES Cable for permanent installation with additional rodent protection (easy to strip), 2x18AWG1	Application
Bare copper wire Ø 1.05 mm (0.041 in), insulation of foamed PE with skin Ø 2.55 mm (0.100 in)	Bare copper wire Ø 1.05 mm (0.041 in), insulation of foamed PE with skin Ø 2.55 mm (0.100 in)	Bare copper wire Ø 1.05 mm (0.041 in), insulation of foamed PE with skin Ø 2.55 mm (0.100 in)	Conductor
2 wires twisted to a pair with fillers in gaps	2 wires twisted to a pair with fillers in gaps	2 wires twisted to a pair Inner jacket: PVC	Core
Alulminate foil overlapped, shield braiding of tinned copper wires Ø 0.15 mm (0.006 in)	Alulminate foil overlapped, copper tape longitudinal welded and spiral corrugated	Alulminate foil overlapped, shield braiding of tinned copper wires Ø 0.15 mm (0.006 in)	Shield
[a] PVC black Ø 7.5 + 0.2 – 0.25 mm (0.295 + 0.008 – 0.010 in) [b] PVC blue Ø 7.5 + 0.2 - 0.25 mm (0.295 + 0.008 - 0.010 in)	PVC blue Ø 11.1 ± 0.3 mm (0.437 ± 0.012 in)	Inner jacket: PVC black Ø 8.0 ± 0.4 mm (0.315 ± 0.016 in) Armouring: 2 layers of galvanised steel tape, intercalated tapes Outer jacket: PE black Ø 10.8 ± 0.5 mm (0.425 ± 0.020 in)	Jacket
Flame retardant acc. to IEC 60332-1-2 and UL 2556 Sec. 9.4 (VW-1), oil resistant acc. to UL 13 Sec. 40 (60°C, 140°F), sunlight resistant acc. to UL 2556 Sec. 4.2.8.5, UL-File E119100 Vol. 1 Sec. 8 Page 1	Flame retardant acc. to IEC 60332-1-2, oil resistant acc. to UL 758 Sec. 19 (60°C, 140°F), sunlight resistant	Sunlight resistant, limited mineral oil and fat resistant	Characteristics
[a] 02YS(ST)CY 1x2x1.0/2.55-100 OE FR [b] 02YS(ST)CY 1x2x1.0/2.55-100 BL OE FR	02YS(ST)WKY 1x2x1.0/2.55-100 BL OE FR	02YSY(ST)CYB2Y 1x2x1.0/2.55-100 (2B0.10 VZK) BK	Type designation
[a] L45467-J20-C75 [b] L45467-J20-C85	L45467-J20-C135	L45467-J20-C26	Order number

FOUNDATION™ Fieldbus



Cable characteristics:



- Flame retardant
- Sunlight resistant
- Oil resistant
- Cold resistant
- Flexible installation
- Permanent installation
- Outdoor cable
- Silicon free
- Compliant acc. to 2011/65/EC (RoHS 2)



Using our **product finder** you can find appropriate solutions for your application.

FOUNDATION™ is a registered trademark of the Fieldbus Foundation

www.fieldbus.org

 <p>FOUNDATION™ Fieldbus</p>	 <p>FOUNDATION™ Fieldbus</p>	 <p>FOUNDATION™ Fieldbus</p>	
<p>Cable for flexible installation indoor or outdoor, (2+1)x19AWG, UL listed: CMG and CL3</p>	<p>EMC cable for permanent installation indoor or outdoor with high electromagnetic compatibility, 2x19AWG, UL listed: CMG and PLTC</p>	<p>Cable for flexible installation indoor or outdoor, 2x19AWG, UL listed: CMG and CL3</p>	Application
<p>Wire LIY 0.8/2.0 Stranded bare copper wire 41x0.16 mm (0.006 in), Ø 1.17 mm (0.046 in), insulation of PVC Ø 2.0 mm (0.079 in)</p> <p>Screened pair 2X(ST) Stranded bare copper wire 37x0.17 mm (0.007 in), Ø 1.17 mm (0.046 in), insulation of cross-linked PE Ø 2.85 mm (0.112 in), 2 wires twisted to a pair</p>	<p>Wire LIY 0.8/2.0 Stranded bare copper wire 41x0.16 mm (0.006 in), Ø 1.17 mm (0.046 in), insulation of PVC Ø 2.0 mm (0.079 in)</p> <p>Screened pair 2X(ST) Stranded bare copper wire 37x0.17 mm (0.007 in), Ø 1.17 mm (0.046 in), insulation of cross-linked PE Ø 2.85 mm (0.112 in), 2 wires twisted to a pair</p>	<p>Stranded bare copper wire 37x0.17 mm (0.007 in), Ø 1.17 mm (0.046 in), insulation of cross-linked PE Ø 2.85 mm (0.112 in)</p>	Conductor
<p>1 screened pair, 1 wire</p>	<p>1 screened pair, 1 wire Inner jacket: PVC</p>	<p>2 wires twisted to a pair</p>	Core
<p>Alulaminat foil overlapped, shield braiding of tinned copper wires Ø 0.15 mm (0.006 in), stranded tinned copper drain wire 0.5 mm² (0.020 square in)</p>	<p>Alulaminat foil overlapped, copper tape longitudinal welded and spiral corrugated, stranded tinned copper drain wire 0.5 mm² (0.020 square in)</p>	<p>Alulaminat foil overlapped, shield braiding of tinned copper wires Ø 0.1 mm (0.004 in), stranded tinned copper drain wire 0.5 mm² (0.020 square in)</p>	Shield
<p>PVC yellow Ø 7.9 ± 0.3 mm (0.311 ± 0.012 in)</p>	<p>PVC yellow Ø 12.3 ± 0.3 mm (0.484 ± 0.012 in)</p>	<p>PVC yellow Ø 7.9 ± 0.3 mm (0.311 ± 0.012 in)</p>	Jacket
<p>Flame retardant acc. to UL 1685 (CSA FT 4), oil resistant acc. to UL 13 Sec. 40 (60 °C, 140 °F), sunlight resistant acc. to UL 2556 Sec. 4.2.8.5, UL-File E119100 Vol. 1 Sec. 24 Page 3, UL-File E116441 Vol. 1 Sec. 15 Page 3</p>	<p>Flame retardant acc. to UL 1685 (CSA FT 4) and IEC 60332-3-24, oil resistant acc. to UL 13 Sec. 40 (60 °C, 140 °F), sunlight resistant acc. to UL 2556 Sec. 4.2.8.5, UL-File E119100 Vol. 1 Sec. 24 Page 4, UL-File E116441 Vol. 1 Sec. 15 Page 4</p>	<p>Flame retardant acc. to UL 1685 (CSA FT 4), oil resistant acc. to UL 13 Sec. 40 (60 °C, 140 °F), sunlight resistant acc. to UL 2556 Sec. 4.2.8.5, UL-File E119100 Vol. 1 Sec. 24 Page 2, UL-File E116441 Vol. 1 Sec. 15 Page 2</p>	Characteristics
<p>2X(ST) 1x2x1.1/2.85-100 LI LIY-J(ST)CY 1x0.8 YE OE FR</p>	<p>2X(ST) 1x2x1.1/2.85-100 LI LIY-J(ST)YWYK 1x0.8 YE OE FR</p>	<p>2X(ST)CY 1x2x1.1/2.85-100 LI YE OE FR</p>	Type designation
<p>L45467-J218-W5</p>	<p>L45467-J218-W15</p>	<p>L45467-J18-B5</p>	Order number

DeviceNet™



Cable characteristics:



- Flame retardant
- Sunlight resistant
- Oil resistant
- Cold resistant
- Highly flexible
- Permanent installation
- Trailing cable
- Halogen free
- Silicon free
- Compliant acc. to 2011/65/EC (RoHS2)



Using our **product finder** you can find appropriate solutions for your application.

DeviceNet™ is a registered trademark of the Open DeviceNet Vendor Association

www.odva.org

 <p>DeviceNet™</p>	 <p>DeviceNet™</p>	 <p>DeviceNet™</p>	
<p>[a] Thick cable for permanent installation [b] Economy thick cable for permanent installation 2x18AWG + 2x15AWG UL listed: CMG and PLTC</p>	<p>[a] Thin cable for permanent installation [b] Economy thin cable for permanent installation 2x23AWG + 2x22AWG, UL listed: CMG and CL2</p>	<p>Thick cable for permanent installation 2x18AWG + 2x15AWG UL listed: CMG and PLTC</p>	Application
<p>Data pair 02YS 1.3/3.8 Stranded tinned copper wire 19x0.25 mm (0.010 in), Ø 1.3 mm (0.051 in), insulation of foamed PE with skin Ø 3.8 mm (0.150 in), 2 wires side by side, alulminate foil overlapped</p> <p>Power pair LIY Stranded tinned copper wire 19x0.34 mm (0.013 in), Ø 1.7 mm (0.067 in), insulation of PVC Ø 2.7 mm (0.106 in), 2 wires side by side, alulminate foil overlapped</p>	<p>Data pair 02YS 0.67/1.9 Stranded tinned copper wire 19x0.13 mm (0.005 in), Ø 0.67 mm (0.026 in), insulation of foamed PE with skin Ø 1.9 mm (0.075 in), 2 wires side by side, alulminate foil overlapped</p> <p>Power pair LIY Stranded tinned copper wire 19x0.16 mm (0.006 in), Ø 0.75 mm (0.030 in), insulation of PVC Ø 1.4 mm (0.055 in), 2 wires side by side, alulminate foil overlapped</p>	<p>Data pair 02YS 1.3/3.8 Stranded tinned copper wire 19x0.25 mm (0.010 in), Ø 1.3 mm (0.051 in), insulation of foamed PE with skin Ø 3.8 mm (0.150 in), 2 wires side by side, alulminate foil overlapped</p> <p>Power pair LI2Y Stranded tinned copper wire 19x0.34 mm(0.013 in), Ø 1.7 mm (0.067 in), insulation of PE Ø 2.7 mm (0.106 in), 2 wires side by side, alulminate foil overlapped</p>	Conductor
<p>Central element Stranded tinned copper drain wire, 1 data pair, 1 power pair</p>	<p>Central element Stranded tinned copper drain wire, 1 data pair, 1 power pair</p>	<p>Central element Stranded tinned copper drain wire, 1 data pair, 1 power pair</p>	Core
<p>Shield braiding of tinned copper wires Ø 0.13 mm (0.005 in)</p>	<p>Shield braiding of tinned copper wires Ø 0.13 mm (0.005 in)</p>	<p>Shield braiding of tinned copper wires Ø 0.13 mm (0.005 in)</p>	Shield
<p>PVC grey [a] Ø 12.2 ± 0.3 mm (0.480 ± 0.012 in) [b] Ø 11.0 ± 0.5 mm (0.433 ± 0.020 in)</p>	<p>PVC grey [a] Ø 6.9 ± 0.3 mm (0.272 ± 0.012 in) [b] Ø 6.4 ± 0.3 mm (0.252 ± 0.012 in)</p>	<p>Thermoplastic copolymer (FRNC) violet Ø 12.2 ± 0.3 mm (0.480 ± 0.012 in)</p>	Jacket
<p>Flame retardant acc. to UL 1685 (CSA FT 4), sunlight resistant acc. to UL 2556 Sec. 4.2.8.5, UL-File E119100 Vol. 1 Sec. 17 Page 3, UL-File E116441 Vol. 1 Sec. 7 Page 3 [a] additional: oil resistant acc. to UL 13 Sec. 40 (60 °C, 140 °F)</p>	<p>Flame retardant acc. to UL 1685 (CSA FT 4), sunlight resistant acc. to UL 2556 4.2.8.5, UL-File E119100 Vol. 1 Sec. 17 Page 4, UL-File E116441 Vol. 1 Sec. 7 Page 4 [a] additional: oil resistant acc. to UL 13 Sec. 40 (60 °C, 140 °F)</p>	<p>Flame retardant acc. to UL 1685 (CSA FT 4), halogen free acc. to IEC 60754, sunlight resistant acc. to UL 2556 Sec. 4.2.8.5, UL-File E119100 Vol. 1 Sec. 17 Page 3, UL-File E116441 Vol. 1 Sec. 7 Page 3</p>	Characteristics
<p>02YS 1x2x1.3/3.8-120 LI VZN PIMF LIY CY 1x2x1.5 VZN PIMF GR</p>	<p>[a] 02YS 1x2x0.67/1.9-120 LI VZN PIMF LIY CY 1x2x0.38 VZN PIMF GR [b] 02YS 1x2x0.67/1.9-120 LI VZN PIMF LIY CY 1x2x0.38 VZN PIMF GR</p>	<p>02YS 1x2x1.3/3.8-120 LI VZN PIMF LI2Y CH 1x2x1.5 VZN PIMF VI FRNC</p>	Type designation
<p>[a] L45467-F21-W5 [b] L45467-F21-W55</p>	<p>[a] L45467-F16-W5 [b] L45467-F16-W55</p>	<p>L45467-F21-W6</p>	Order number



DeviceNet™





DeviceNet™



DeviceNet™

Application	Thin cable for permanent installation (FRNC) 2x23AWG + 2x22AWG UL listed: CMG and CL2	[a] Thick cable for high flexible installation [b] Economy thick cable for high flexible installation 2x18AWG + 2x15AWG, UL listed: CMG and PLTC	[a] Thin cable for high flexible installation [b] Economy thin cable for high flexible installation 2x23AWG + 2x22AWG, UL listed: CMG and CL2
Conductor	Data pair 02YS 0.67/1.9 Stranded tinned copper wire 19x0.13 mm (0.005 in), Ø 0.67 mm (0.026 in), insulation of foamed PE with skin Ø 1.9 mm (0.075 in), 2 wires side by side, alulamine foil overlapped Power pair LI2Y Stranded tinned copper wire 19x0.16 mm (0.006 in), Ø 0.75 mm (0.030 in), insulation of PE Ø 1.4 mm (0.055 in), 2 wires side by side, alulamine foil overlapped	Data pair 02YS 1.3/3.8 Stranded tinned copper wire 40x0.18 mm (0.007 in), Ø 1.3 mm (0.051 in), insulation of foamed PE with skin Ø 3.8 mm (0.150 in), 2 wires side by side, alulamine foil overlapped Power pair LIY Stranded tinned copper wire 84x0.16 mm (0.006 in), Ø 1.7 mm (0.067 in), insulation of PVC Ø 2.7 mm (0.106 in), 2 wires side by side, alulamine foil overlapped	Data pair 02YS 0.67/1.9 Stranded tinned copper wire 19x0.13 mm (0.005 in), Ø 0.67 mm (0.026 in), insulation of foamed PE with skin Ø 1.9 mm (0.075 in), 2 wires side by side, alulamine foil overlapped Power pair LIY Stranded tinned copper wire 19x0.16 mm (0.006 in), Ø 0.75 mm (0.030 in), insulation of PVC Ø 1.4 mm (0.055 in), 2 wires side by side, alulamine foil overlapped
Core	Central element Stranded tinned copper drain wire, 1 data pair, 1 power pair	Central element Stranded tinned copper drain wire, 1 data pair, 1 power pair	Central element Stranded tinned copper drain wire, 1 data pair, 1 power pair
Shield	Shield braiding of tinned copper wires Ø 0.13 mm (0.005 in)	Plastic tape conductive, shield braiding of tinned copper wires Ø 0.13 mm (0.005 in)	Plastic tape conductive, shield braiding of tinned copper wires Ø 0.13 mm (0.005 in)
Jacket	Thermoplastic copolymer (FRNC) violet Ø 6.9 ± 0.3 mm (0.272 ± 0.012 in)	PVC grey [a] Ø 12.2 ± 0.3 mm (0.480 ± 0.012 in) [b] Ø 11.4 ± 0.3 mm (0.449 ± 0.012 in)	PVC grey [a] Ø 6.9 ± 0.3 mm (0.272 ± 0.012 in) [b] Ø 6.8 ± 0.3 mm (0.268 ± 0.012 in)
Characteristics	Flame retardant acc. to IEC 60332-1-2, halogen free acc. to IEC 60754, sunlight resistant acc. to UL 2556 Sec. 4.2.8.5, UL-File E119100 Vol. 1 Sec. 17 Page 4, UL-File E116441 Vol. 1 Sec. 7 Page 4	Flame retardant acc. to UL 1685 (CSA FT 4), sunlight resistant acc. to UL 2556 Sec. 4.2.8.5, UL-File E119100 Vol. 1 Sec. 17 Page 3, UL-File E116441 Vol. 1 Sec. 7 Page 3 [a] additional: oil resistant acc. to UL 13 Sec. 40 (60 °C, 140 °F)	Flame retardant acc. to UL 1685 (CSA FT 4), sunlight resistant acc. to UL 2556 Sec. 4.2.8.5, UL-File E119100 Vol. 1 Sec. 17 Page 4, UL-File E116441 Vol. 1 Sec. 7 Page 4, UL-File E116441 Vol. 1 Sec. 7 Page 4, [a] additional: oil resistant acc. to UL 13 Sec. 40 (60 °C, 140 °F)
Type designation	02YS 1x2x0.67/1.9-120 LI VZN PIMF LI2Y CH 1x2x0.38 VZN PIMF VI FRNC	[a] 02YS 1x2x1.3/3.8-120 LI VZN PIMF LIY CY 1x2x1.5 VZN PIMF GR [b] 02YS 1x2x1.3/3.8-120 LI VZN PIMF LIY CY 1x2x1.5 VZN PIMF GR	[a] 02YS 1x2x0.67/1.9-120 LI VZN PIMF LIY CY 1x2x0.38 VZN PIMF GR, [b] 02YS 1x2x0.67/1.9-120 LI VZN PIMF LIY CY 1x2x0.38 VZN PIMF GR
Order number	L45467-F16-W6	[a] L45467-F21-W15 [b] L45467-F21-W65	[a] L45467-F16-W15 [b] L45467-F16-W65

 <p>DeviceNet™</p>	 <p>DeviceNet™</p>	
<p>Thick cable for high flexible installation 2x18AWG + 2x15AWG UL listed: CMX and CL2X</p>	<p>Thin cable for high flexible installation 2x23AWG + 2x22AWG UL listed: CMX and CL2X</p>	Application
<p>Data pair 02YS 1.3/3.8 Stranded tinned copper wire 40x0.18 mm (0.007 in), Ø 1.3 mm (0.051 in), insulation of foamed PE with skin Ø 3.8 mm (0.150 in), 2 wires side by side, alulamine foil overlapped</p> <p>Power pair LI2Y Stranded tinned copper wire 84x0.16 mm (0.006 in), Ø 1.7 mm (0.067 in), insulation of PE Ø 2.7 mm (0.106 in), 2 wires side by side, alulamine foil overlapped</p>	<p>Data pair 02YS 0.67/1.9 Stranded tinned copper wire 19x0.13 mm (0.005 in), Ø 0.67 mm (0.026 in), insulation of foamed PE with skin Ø 1.9 mm (0.075 in), 2 wires side by side, alulamine foil overlapped</p> <p>Power pair LI2Y Stranded tinned copper wire 19x0.16 mm (0.006 in), Ø 0.75 mm (0.030 in), insulation of PE Ø 1.4 mm (0.055 in), 2 wires side by side, alulamine foil overlapped</p>	Conductor
<p>Central element Stranded tinned copper drain wire, 1 data pair, 1 power pair</p>	<p>Central element Stranded tinned copper drain wire, 1 data pair, 1 power pair</p>	Core
<p>Plastic tape conductive, shield braiding of tinned copper wires Ø 0.13 mm (0.005 in)</p>	<p>Plastic tape conductive, shield braiding of tinned copper wires Ø 0.13 mm (0.005 in)</p>	Shield
<p>TPU violet Ø 12.2 ± 0.3 mm (0.480 ± 0.012 in)</p>	<p>TPU violet Ø 6.9 ± 0.3 mm (0.272 ± 0.012 in)</p>	Jacket
<p>Flame retardant acc. to 2556 Sec. 9.4 (VW-1), halogen free acc. to IEC 60754, sunlight resistant acc. to UL 2556 Sec. 4.2.8.5, oil resistant acc. to UL 13 Sec. 40 (60 °C, 140 °F), UL-File E119100 Vol. 1 Sec. 17 Page 1, UL-File E116441 Vol. 1 Sec. 7 Page 1</p>	<p>Flame retardant acc. to UL 2556 Sec. 9.4 (VW-1), halogen free acc. to IEC 60754, sunlight resistant acc. to UL 2556 Sec. 4.2.8.5, oil resistant acc. to UL 13 Sec. 40 (60 °C, 140 °F), UL-File E119100 Vol. 1 Sec. 17 Page 2, UL-File E116441 Vol. 1 Sec. 7 Page 2</p>	Characteristics
<p>02YS 1x2x1.3/3.8-120 LI VZN PIMF LI2Y C11Y 1x2x1.5 VZN PIMF VI FRNC</p>	<p>02YS 1x2x0.67/1.9-120 LI VZN PIMF LI2Y C11Y 1x2x0.38 VZN PIMF VI FRNC</p>	Type designation
<p>L45467-F21-W8</p>	<p>L45467-F16-W8</p>	Order number

CAN



Cable characteristics:

- Flame retardant
- Oil resistant
- Cold resistant
- Highly flexible
- Permanent installation
- Trailing cable
- Halogen free
- Silicon free
- Compliant acc. to 2011/65/EC (RoHS 2)





Using our **product finder** you can find appropriate solutions for your application.

CiA® and CANopen® are registered Community Trademarks of CAN in Automation e.V.

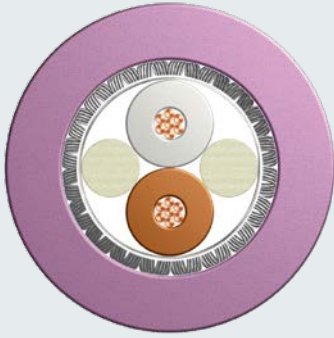
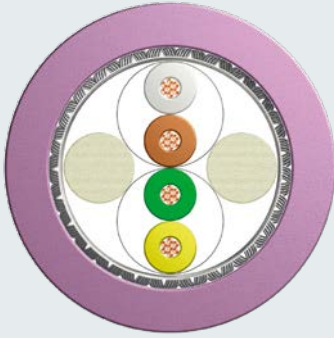
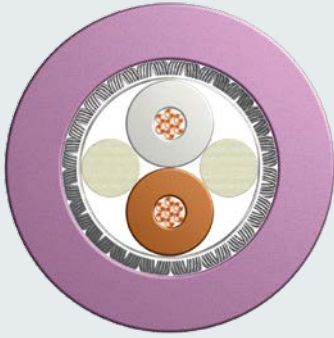
www.can-cia.org

			
CAN	CAN	CAN	
Cable for permanent and flexible installation [a] 2x24AWG7 [b] 2x22AWG7 [c] 2x20AWG7 UL recognised: AWM	Cable for permanent and flexible installation [a] 2x2x24AWG7 [b] 2x2x22AWG7 [c] 2x2x21AWG7 UL listed: CMX	Cable for high flexible installation in harsh environments [a] 2x24AWG19 [b] 2x22AWG44 [c] 2x21AWG66	Application
Stranded bare copper wire [a] 7x0.2 mm (0.008 in), Ø 0.6 mm (0.024 in) [b] 7x0.25 mm (0.010 in), Ø 0.75 mm (0.030 in) [c] 7x0.3 mm (0.012 in), Ø 0.9 mm (0.035 in), insulation of foamed PE with skin [a] Ø 1.55 mm (0.061 in) [b] Ø 2.0 mm (0.079 in) [c] Ø 2.4 mm (0.095 in)	Stranded bare copper wire [a] 7x0.2 mm (0.008 in), Ø 0.6 mm (0.024 in) [b] 7x0.25 mm (0.010 in), Ø 0.75 mm (0.030 in) [c] 7x0.3 mm (0.012 in), Ø 0.9 mm (0.035 in), insulation of foamed PE with skin [a] Ø 1.3 mm (0.051 in) [b] Ø 1.7 mm (0.067 in) [c] Ø 2.0 mm (0.079 in)	Stranded bare copper wire [a] 19x0.135 mm (0.005 in), Ø 0.7 mm (0.028 in) [b] 44x0.1 mm (0.004 in), Ø 0.75 mm (0.030 in) [c] 66x0.1 mm (0.004 in), Ø 0.95 mm (0.037 in), insulation of foamed PE with skin [a] Ø 1.6 mm (0.063 in) [b] Ø 2.0 mm (0.079 in) [c] Ø 2.4 mm (0.095 in)	Conductor
2 wires twisted to a pair with fillers in gaps	2 wires twisted to a pair with fillers in gaps, 2 pairs twisted	2 wires twisted to a pair with fillers in gaps	Core
Shield braiding of tinned copper wires [a] Ø 0.10 mm (0.004 in) [b+c] Ø 0.13 mm (0.005 in)	Shield braiding of tinned copper wires [a+b] Ø 0.13 mm (0.005 in) [c] Ø 0.15 mm (0.016 in)	Shield braiding of tinned copper wires [a] Ø 0.15 mm (0.016 in) [b+c] Ø 0.13 mm (0.005 in)	Shield
PVC violet [a] Ø 5.8 ± 0.3 mm (0.228 ± 0.012 in) [b] Ø 6.8 ± 0.3 mm (0.268 ± 0.012 in) [c] Ø 7.5 ± 0.3 mm (0.295 ± 0.012 in)	PVC violet [a] Ø 7.5 ± 0.3 mm (0.295 ± 0.012 in) [b] Ø 8.5 ± 0.3 mm (0.335 ± 0.012 in) [c] Ø 9.6 ± 0.3 mm (0.378 ± 0.012 in)	TPU violet [a] Ø 6.5 ± 0.3 mm (0.256 ± 0.012 in) [b] Ø 6.9 ± 0.3 mm (0.027 ± 0.012 in) [c] Ø 7.7 ± 0.3 mm (0.303 ± 0.012 in)	Jacket
Flame retardant acc. to IEC 60332-1-2, UL-Style 2464	Flame retardant acc. to IEC 60332-1-2, UL-File E119100 Vol. 1 Sec. 25 Page 1, UL-Style 2464	Flame retardant acc. to IEC 60332-1-2, oil resistant acc. to IEC 60811-2-1 [b] additional: UL-Style 20351	Characteristics
[a] L-02YSCY 1x2x0.22/1.55-120 VI [b] L-02YSCY 1x2x0.34/2.0-120 VI [c] L-02YSCY 1x2x0.5/2.4-120 VI	[a] L-02YSCY 2x2x0.22/1.55-120 VI [b] L-02YSCY 2x2x0.34/1.7-120 VI [c] L-02YSCY 2x2x0.5/2.0-120 VI	[a] L-02YSC11Y 1x2x0.25/1.6-120 VI FR [b] L-02YSC11Y 1x2x0.34/2.0-120 VI FR [c] L-02YSC11Y 1x2x0.5/2.4-120 VI FR	Type designation
[a] L45551-A21-C35 [b] L45551-P21-C5 [c] L45551-C21-C5	[a] L45551-A22-C5 [b] L45551-P22-C5 [c] L45551-C22-C5	[a] L45551-B21-C8 [b] L45551-P21-C8 [c] L45551-C21-C8	Order number

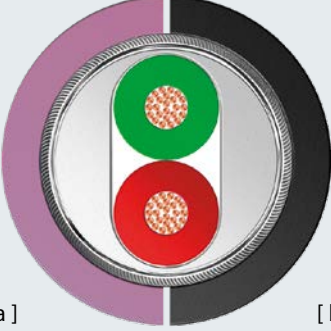
	 <p>CAN</p>	 <p>CAN</p>	 <p>CAN</p>
Application	Trailing cable for high flexible installation in harsh environments 4x24AWG19 UL listed: CMX	Trailing cable for high flexible installation in harsh environments 4x22AWG19 UL listed: CMX	Trailing cable for high flexible installation in harsh environments 4x21AWG66 UL listed: CMX
Conductor	Stranded bare copper wire 19x0.125 mm (0.005 in), Ø 0.6 mm (0.024 in), insulation of foamed PE Ø 1.4 mm (0.055 in)	Stranded bare copper wire 19x0.16 mm (0.006 in), Ø 0.77 mm (0.030 in), insulation of foamed PE Ø 1.8 mm (0.071 in)	Stranded bare copper wire 66x0.1 mm (0.004 in), Ø 0.95 mm (0.037 in), insulation of foamed PE Ø 2.3 mm (0.091 in)
Core	4 wires twisted to a quad	4 wires twisted to a quad	4 wires twisted to a quad
Shield	Shield braiding of tinned copper wires Ø 0.1 mm (0.004 in)	Shield braiding of tinned copper wires Ø 0.13 mm (0.005 in)	Shield braiding of tinned copper wires Ø 0.15 mm (0.006 in)
Jacket	TPU violet Ø 6.4 ± 0.2 mm (0.252 ± 0.008 in)	TPU violet Ø 7.4 ± 0.2 mm (0.291 ± 0.008 in)	TPU violet Ø 8.8 ± 0.4 mm (0.346 ± 0.016 in)
Characteristics	Sunlight resistant, UL-File E119100 Vol. 1 Sec. 25 Page 1	Sunlight resistant, UL-File E119100 Vol. 1 Sec. 25 Page 1	Sunlight resistant, halogen free acc. to IEC 60754, UL-File E119100 Vol. 1 Sec. 25 Page 1
Type designation	L-02YC11Y 2x2x0.22/1.4-120 VI FR	L-02YC11Y 2x2x0.38 VI FR	L-02YC11Y 2x2x0.5/2.3-120 VI FRNC
Order number	L45551-B14-C8	L45551-P14-C8	L45551-C14-C8

 <p>CAN</p>	 <p>[a]</p>  <p>[b]</p> <p>CAN ES</p>	 <p>CAN ES</p>	
<p>Trailing cable for high flexible installation in harsh environments 4x19AWG37 UL listed: CMX</p>	<p>Cable for marine applications (easy to strip) [a] 2x21AWG19 [b] 2x21AWG19</p>	<p>Cable for marine applications (easy to strip) 4x21AWG19</p>	Application
<p>Stranded bare copper wire 37x0.16 mm Ø 1.12 mm (0.044 in), insulation of foamed PE Ø 2.6 mm (0.102 in)</p>	<p>Stranded tinned copper wire 19x0.18 mm Ø 0.9 mm (0.035 in), insulation of foamed PP with skin Ø 2.4 mm (0.094 in)</p>	<p>Stranded tinned copper wire 19x0.18 mm Ø 0.9 mm (0.035 in), insulation of foamed PP with skin Ø 2.2 mm (0.094 in)</p>	Conductor
<p>4 wires twisted to a quad</p>	<p>2 wires twisted to a pair with fillers in gaps, plastic tape, overlapped Inner jacket: FRNC</p>	<p>Fillers as central element 4 wires, plastic tape, overlapped Inner jacket: FRNC</p>	Core
<p>Shield braiding of tinned copper wires Ø 0.15 mm (0.006 in)</p>	<p>Alulminate foil overlapped, applied longitudinally, shield braiding of tinned copper wires Ø 0.13 mm (0.005 in)</p>	<p>Alulminate foil overlapped, shield braiding of tinned copper wires Ø 0.13 mm (0.005 in)</p>	Shield
<p>TPU violet Ø 9.0 ± 0.2 mm (0.374 ± 0.008 in)</p>	<p>[a] Thermoplastic copolymer (FRNC) violet Ø 7.7 ± 0.2 mm (0.303 ± 0.008 in) [b] Thermoplastic copolymer (FRNC) black Ø 7.7 ± 0.2 mm (0.303 ± 0.008 in)</p>	<p>Thermoplastic copolymer (FRNC) black Ø 8.4 ± 0.2 mm (0.331 ± 0.008 in)</p>	Jacket
<p>Sunlight resistant, halogen free acc. to IEC 60754, UL-File E119100 Vol. 1 Sec. 25 Page 1</p>	<p>Flame retardant acc. to IEC 60332-3-22 (Cat A/F), halogen free acc. to IEC 60754 Maritime and offshore approvals: Germanischer Lloyd, Det Norske Veritas</p>	<p>Flame retardant acc. to IEC 60332-3-22 (Cat A/F), halogen free acc. to IEC 60754 Maritime and offshore approvals: Germanischer Lloyd, Det Norske Veritas, Lloyds Register</p>	Characteristics
<p>L-02YC11Y 2x2x0.75/2.6-120 VI FRNC</p>	<p>[a] 09YSH(ST)CH 1x2x0.9/2.4-120 LI VZN VI FRNC [b] 09YSH(ST)CH 1x2x0.9/2.4-120 LI VZN BK FRNC</p>	<p>09YSH(ST)CH 2x2x0.9/2.2-120 LI VZN BK FRNC</p>	Type designation
<p>L45551-D14-C8</p>	<p>[a] L45467-F19-C6 [b] L45467-F19-C16</p>	<p>L45467-F19-C26</p>	Order number

CC-Link®

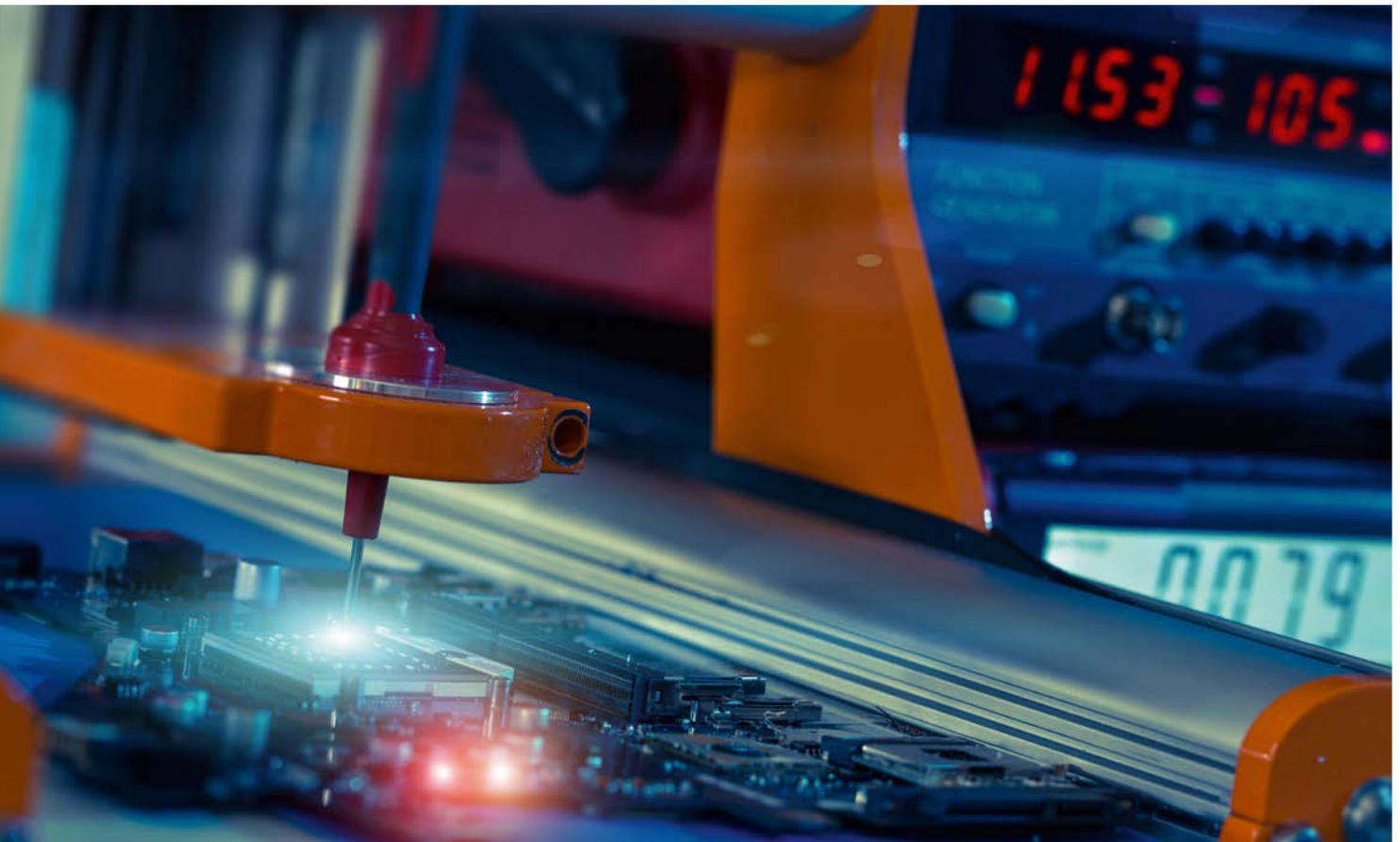

Cable characteristics:

- Flame retardant
- Sunlight resistant
- Cold resistant
- Flexible installation
- Permanent installation
- Trailing cable with up to 3 million bending cycles
- Silicon free
- Compliant acc. to 2011/65/EC (RoHS2)

LEONI Special Cables with its Business Unit Automation & Drives is a member of the CC-Link Partner Association (CLPA)



CC-Link is a registered trademark of the Mitsubishi Electric Corporation



Using our **product finder** you can find appropriate solutions for your application.

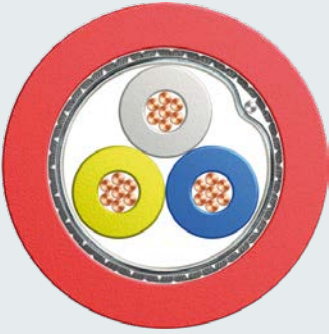

www.cc-link.org

 <p>CC-Link</p>	 <p>CC-Link ES</p>	 <p>CC-Link</p>	
<p>Cable for flexible installation, compliant with CC-Link specification 1.10, capable of 10 Mbps operation 3x20AWG7 UL listed: CM and PLTC</p>	<p>Trailing cable (easy to strip) 3x20AWG71 UL recognised: AWM</p>	<p>Power limited tray cable for flexible installation, compliant with CC-Link specification 1.10, capable of 10 Mbps operation 3x20AWG67 and 2x18AWG67</p>	Application
<p>Stranded bare copper wire 7x0.32 mm (0.013 in), Ø 0.96 mm (0.038 in), insulation of foamed PE with skin Ø 2.2 mm (0.087 in)</p>	<p>Stranded bare copper wire 71x0.1 mm Ø 1.0 mm (0.039 in), insulation of foamed PE with skin Ø 2.2 mm (0.087 in)</p>	<p>Wire LIY 0.9/2.3 Stranded tinned copper wire 7x0.4 mm (0.016 in), Ø 1.21 mm (0.048 in), insulation of PVC Ø 2.3 mm (0.091 in)</p> <p>Wire 02YS Stranded bare copper wire 7x0.32 mm (0.13 in), Ø 0.96 mm (0.038 in), insulation of foamed PE with skin Ø 2.2 mm (0.087 in)</p> <p>Triple 02YS(ST)CY 3 wires, alulminate foil overlapped, stranded tinned copper drain wire 0.38 mm² (0.015 square in), shield braiding of tinned copper wires Ø 0.13 mm (0.005 in) jacket: PVC red</p>	Conductor
<p>3 wires twisted, alulminate foil overlapped, stranded tinned copper drain wire 0.38 mm² (0.015 square in)</p>	<p>3 wires twisted Inner jacket: FRNC</p>	<p>Triple, 2 wires</p>	Core
<p>Shield braiding of tinned copper wires Ø 0.13 mm (0.005 in)</p>	<p>Shield braiding of tinned copper wires Ø 5.9 mm (0.232 in)</p>		Shield
<p>PVC red Ø 7.7 ± 0.3 mm (0.303 ± 0.012 in)</p>	<p>TPU red Ø 8.5 ± 0.3 mm (0.335 ± 0.012 in)</p>	<p>PVC red Ø 12.8 ± 0.3 mm (0.504 in ± 0.012 in)</p>	Jacket
<p>UL-File E119100 Vol. 1 Sec. 19 Page 1, UL-File E116441 Vol. 1 Sec. 11 Page 1</p>	<p>UL-Style 20233 (80 °C, 176 °F / 300 V), halogen free acc. to IEC 60754</p>		Characteristics
<p>02YS(ST)CY 3x1x0.96/2.2-110 LI RD</p>	<p>02YSHC11Y 3x1x1.0/2.2-110 LI RD</p>	<p>02YS(ST)CY 3x1x0.96/2.2-110 LI LIY Y 2x1x0.9 RD</p>	Type designation
<p>L45467-Y19-C15</p>	<p>L45467-Y20-C28</p>	<p>L45467-Y19-W5</p>	Order number

KNX (EIB)



Cable characteristics:

- Flame retardant
- Cold resistant
- Permanent installation
- Halogen free
- Silicon free
- Compliant acc. to 2011/65/EC (RoHS2)



Using our **product finder** you can find appropriate solutions for your application.

www.knx.org

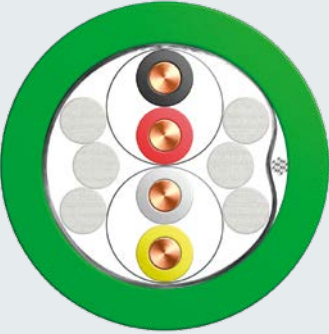
 <p>KNX (EIB)</p>	 <p>KNX (EIB)</p>	
<p>KNX / European Installation bus cable for permanent installation 4x20AWG1</p>	<p>KNX / European Installation bus cable for permanent installation (FRNC) 2x2x20AWG1</p>	Application
<p>Bare copper wire $\varnothing 0.8$ mm (0.031 in), insulation of PVC $\varnothing 1.6$ mm (0.063 in)</p>	<p>Bare copper wire $\varnothing 0.8$ mm (0.031 in), insulation of PE $\varnothing 1.4$ mm (0.055 in)</p>	Conductor
<p>4 wires twisted to a quad</p>	<p>2 wires twisted to a pair, 2 pairs</p>	Core
<p>Tinned copper drain wire $\varnothing 0.4$ mm² (0.016 square in), alulaminated foil overlapped</p>	<p>Stranded tinned drain wire of 0.14 mm² (0.006 square in), alulaminated foil overlapped</p>	Shield
<p>PVC green $\varnothing 6.1$ mm (0.240 in)</p>	<p>Thermoplastic copolymer (FRNC) green $\varnothing 6.3 + 0.4 - 0.2$ mm (0.248 + 0.016 - 0.008 in)</p>	Jacket
<p>Flame retardant acc. to IEC 60332-1-2</p>	<p>Flame retardant acc. to IEC 60332-1-2, halogen free acc. to IEC 60754</p>	Characteristics
<p>J-Y(ST) Y 2x2x0.8 GN</p>	<p>J-H(ST)H 2x2x0.8 FRNC GN</p>	Type designation
<p>L45480-F25-B155</p>	<p>V45493-D49-A159</p>	Order number

AS-Interface



Cable characteristics:

- Flame retardant
- Oil resistant
- Chemical resistant
- Cold resistant
- Highly flexible
- Permanent installation
- Trailing cable
- Halogen free
- Silicon free
- Compliant acc. to 2011/65/EC (RoHS2)









Using our **product finder** you can find appropriate solutions for your application.

LEONI Special Cables with its Business Unit Automation & Drives is a member of the AS-International Association e.V.



www.as-interface.net

 <p>[a]</p>  <p>[b]</p> <p>AS-Interface</p>	 <p>[a]</p>  <p>[b]</p> <p>AS-Interface</p>	 <p>[a]</p>  <p>[b]</p> <p>AS-Interface</p>	
<p>[a] Economy rubber cable 2x1.5 mm² (0.059 square in)</p> <p>[b] Economy rubber cable for additional power (24V DC), 2x1.5 mm² (0.059 square in)</p>	<p>TPE-cable for the chemical and automotive industry</p> <p>[a] 2x1.5 mm² (0.059 square in) UL and CSA certified AWM</p> <p>[b] for additional power (24V DC) 2x1.5 mm² (0.059 square in) UL and CSA certified AWM</p>	<p>Trailing cable</p> <p>[a] 2x1.5 mm² (0.059 square in)</p> <p>[b] for additional power (24V DC), 2x1.5 mm² (0.059 square in)</p>	Application
<p>[a] Stranded tinned copper wire Ø 1.5 mm (0.059 in), insulation of EPDM Ø 2.5 mm (0.098 in)</p> <p>[b] Stranded tinned copper wire Ø 1.5 mm (0.059 in), insulation of EPDM Ø 2.5 mm (0.098 in)</p>	<p>Stranded tinned copper wire 84x0.15 mm (0.006 in), Ø 1.5 mm (0.059 in), insulation of TPE Ø 2.5 mm (0.098 in)</p>	<p>Stranded tinned copper wire 84x0.15 mm (0.006 in), Ø 1.5 mm (0.059 in), insulation of TPE Ø 2.5 mm (0.098 in)</p>	Conductor
<p>[a] Rubber (EPDM) yellow</p> <p>[b] Rubber (EPDM) black</p>	<p>[a] TPE compound yellow</p> <p>[b] TPE compound black</p>	<p>[a] TPU yellow</p> <p>[b] TPU black</p>	Jacket
<p>Halogen free</p>	<p>Flame retardant acc. to IEC 60332-1-2 and UL 1581 Sec. 1061 (cable-flame), oil and cut oil resistant acc. to UL 758 Sec. 15 (60 °C, 140 °F), cold bending resistant acc. to IEC 60811-1-4, UL-Style 2103, CSA-File LL55255-42</p>	<p>Flame retardant acc. to IEC 60332-1-2, oil and cut oil resistant acc. to UL 758 Sec. 15 (60 °C, 140 °F), cold bending resistant acc. to IEC 60811-1-4, halogen free acc. to IEC 60754</p>	Characteristics
<p>[a] FLI-3G3G 2x1x1.5 VZN YE</p> <p>[b] FLI-3G3G 2x1x1.5 VZN BK</p>	<p>[a] FLI-99Y99Y 2x1x1.5 VZN YE</p> <p>[b] FLI-99Y99Y 2x1x1.5 VZN BK</p>	<p>[a] FLI-9Y11Y 2x1x1.5 VZN FRNC YE</p> <p>[b] FLI-9Y11Y 2x1x1.5 VZN FRNC BK</p>	Type designation
<p>[a] L45587-M21-Y1</p> <p>[b] L45587-M21-Y11</p>	<p>[a] L45587-M21-Y139</p> <p>[b] L45587-M21-Y149</p>	<p>[a] L45587-M21-B58</p> <p>[b] L45587-M21-B68</p>	Order number

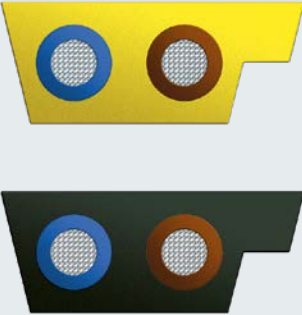
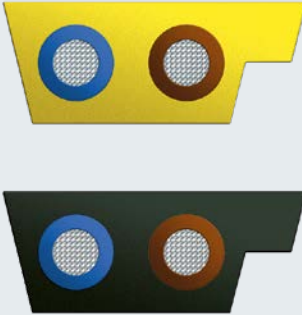
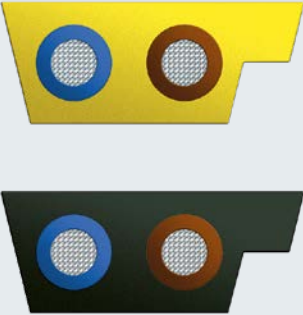
	 <p>[a]</p> <p>[b]</p> <p>AS-Interface</p>	 <p>[a]</p> <p>[b]</p> <p>AS-Interface</p>	 <p>[a]</p> <p>[b]</p> <p>AS-Interface</p>
Application	<p>Cable for the US-American and Canadian market</p> <p>[a] 2x1.5 mm² (0.059 square in) UL listed: CMG and CL2</p> <p>[b] for additional power (24V DC) 2x1.5 mm² (0.059 square in) UL listed: CMG and CL2</p>	<p>Cable for marine applications</p> <p>[a] 2x1.5 mm² (0.059 square in)</p> <p>[b] for additional power (24V DC), 2x1.5 mm² (0.059 square in)</p>	<p>Trailing cable with thick wires for less voltage drop, 2x2.5 mm²</p>
Conductor	<p>Stranded tinned copper wire 84x0.15 mm (0.006 in), Ø 1.5 mm (0.059 in), insulation of TPE Ø 2.5 mm (0.098 in)</p>	<p>Stranded tinned copper wire 84x0.15 mm (0.006 in), Ø 1.5 mm (0.059 in), insulation of FRNC Ø 2.5 mm (0.098 in)</p>	<p>Stranded tinned copper wire 140x0.15 mm (0.006 in), Ø 2.0 mm (0.079 in), insulation of TPE Ø 2.5 mm (0.098 in)</p>
Jacket	<p>[a] PVC compound LEONI CL2 yellow</p> <p>[b] PVC compound LEONI CL2 black</p>	<p>[a] TPU yellow</p> <p>[b] TPU black</p>	<p>[a] TPU yellow</p> <p>[b] TPU black</p>
Characteristics	<p>Flame retardant acc. to IEC 60332-1-2, oil resistant acc. to UL 13 Sec. 40 (60°C, 140°F), UL-File E119100 Vol. 1 Sec. 10 Page 1, UL-File E116441 Vol. 1 Sec. 5 Page 1</p> <p>Temperature range: – 40°C (– 40°F) up to 90°C (194°F)</p>	<p>Flame retardant acc. to IEC 60332-1-2, cold bending resistant, halogen free acc. to IEC 60754, oil resistant acc. to IEC 60811-2-1</p> <p>Maritime and offshore approvals:</p> <p>[a] Germanischer Lloyd, Lloyds Register of Shipping, ABS Europe Ltd., Bureau Veritas, Det Norske Veritas</p> <p>[b] VDE Reg. No. 9971, Germanischer Lloyd, Lloyds Register of Shipping, ABS Europe Ltd., Bureau Veritas, Det Norske Veritas</p>	<p>Flame retardant acc. to IEC 60332-1-2</p>
Type designation	<p>[a] FLI-99Y99Y 2x1x1.5 VZN FR YE</p> <p>[b] FLI-99Y99Y 2x1x1.5 VZN FR BK</p>	<p>[a] FLI-9Y11Y 2x1x1.5 VZN FRNC YE</p> <p>[b] FLI-9Y11Y 2x1x1.5 VZN FRNC BK</p>	<p>[a] FLI-9Y11Y 2x1x2.5 VZN YE</p> <p>[b] FLI-9Y11Y 2x1x2.5 VZN BK</p>
Order number	<p>[a] L45587-M21-Y109</p> <p>[b] L45587-M21-Y119</p>	<p>[a] L45587-M21-B38</p> <p>[b] L45587-M21-B48</p>	<p>[a] L45587-M21-B198</p> <p>[b] L45587-M21-B208</p>



**Round cable
for AS-Interface applications**

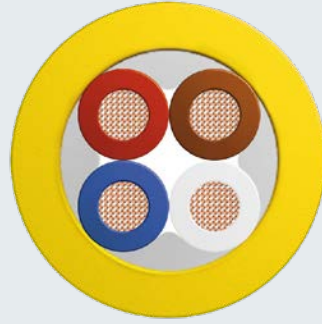

**Round cable
for AS-Interface applications**

Round cable for materials handling equipment (FRNC), 4x12AWG additional UL listed: PLTC-ER and ITC-ER	Round cable for materials handling equipment (FRNC), 4x12AWG additional UL listed: PLTC-ER and ITC-ER	Application
Stranded bare copper wire 77x0.26 mm (0.010 in), Ø 2.9 mm (0.114 in), insulation of special Polyolefin Ø 4.8 mm (0.189 in)	Stranded bare copper wire 77x0.26 mm (0.010 in), Ø 2.6 mm (0.102 in), insulation of special Polyolefin Ø 4.8 mm (0.189 in)	Conductor
4 wires twisted to a star-quad Ø 11.6 mm (0.457 in) Inner jacket: FRNC	4 wires twisted to a star-quad Ø 11.6 mm (0.457 in) Inner jacket: FRNC	Core
Thermoplastic copolymer (FRNC) yellow with longitudinal black stripe Ø 15.1 ± 0.2 mm (0.594 ± 0.008 in)	Thermoplastic copolymer (FRNC) yellow with longitudinal black stripe Ø 15.1 ± 0.2 mm (0.594 ± 0.008 in)	Jacket
Sunlight resistant acc. to UL 2556 Sec. 4.2.8.5, temperature range: – 25 °C (– 13 °F) up to 80 °C (176 °F), flame retardant acc. to IEC 60332-1-2, UL-File E116441 Vol. 1 Sec. 19 Page 2, UL-File E306668 Vol. 1 Sec. 10 Page 2, UL-Style 21287, halogen free acc. to IEC 60754	Sunlight resistant acc. to UL 2556 Sec. 4.2.8.5, temperature range: – 40 °C (– 40 °F) up to 105 °C (221 °F), oil resistant acc. to UL 13 Sec. 40 (60 °C, 140 °F), halogen free acc. to IEC 60754	Characteristics
99YHH 4x1x4.0/4.8 LI YE	99XHH 4x1x4.0/4.8 LI YE	Type designation
L45550-H41-B36	L45550-H41-B26	Order number

USB and Fire Wire

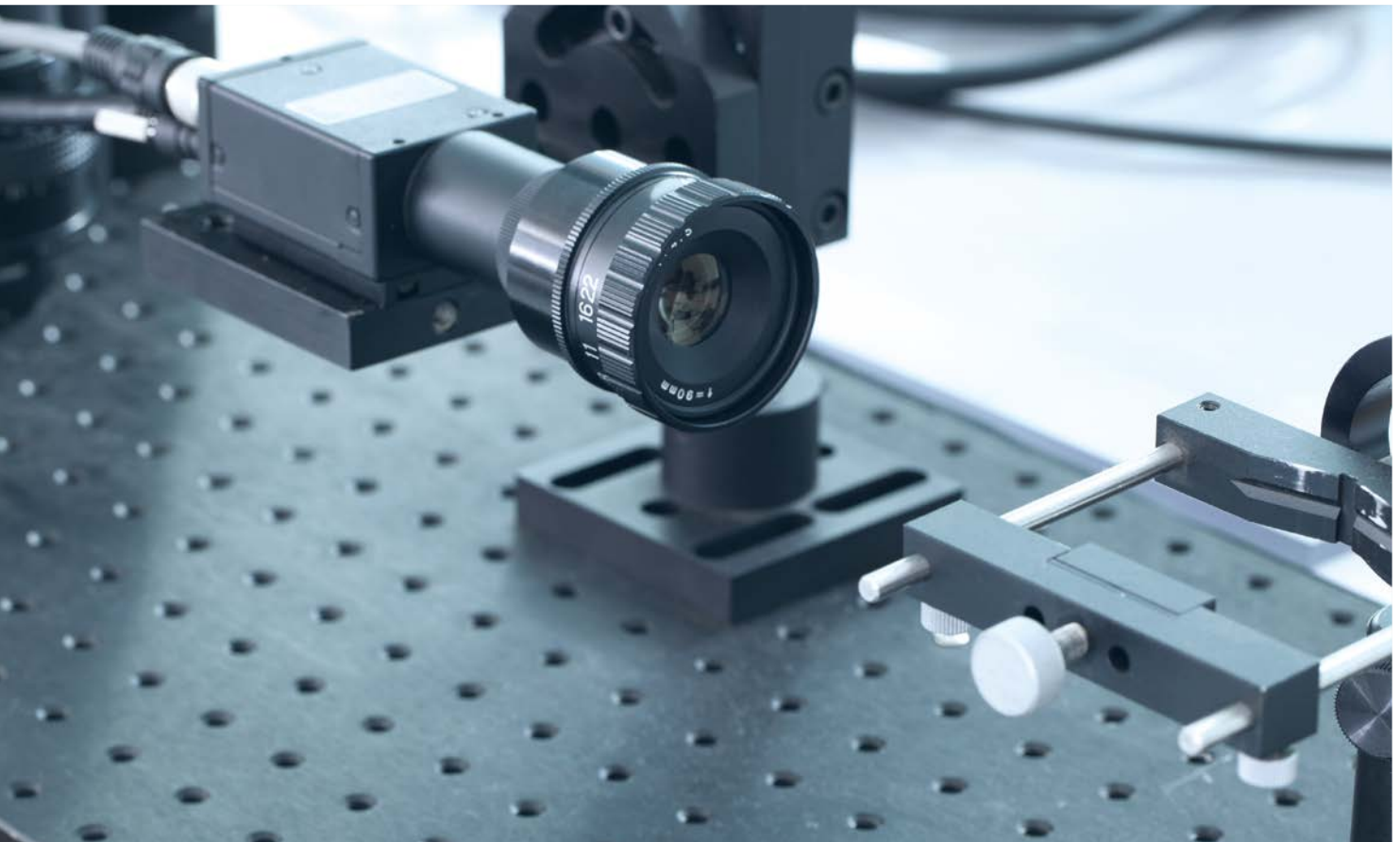



Cable characteristics:

- Flame retardant
- Sunlight resistant
- Oil resistant
- Chemical resistant
- Highly flexible
- Compliant acc. to 2011/65/EC (RoHS2)



Using our **product finder** you can find appropriate solutions for your application.

Fire Wire is a registered trademark of Apple

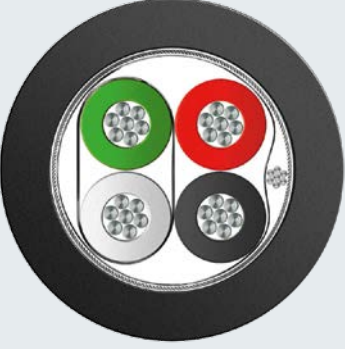
 <p>Fire Wire IEEE 1394b</p>	 <p>USB 3.0</p>	 <p>USB</p>	
<p>Cable for flexible use in harsh environments, 2x2x30AWG7 + 2x26AWG7, UL recognised: AWM</p>	<p>Cable for flexible installation, use in harsh environments, 2x2x28AWG7 + 1x2x28AWG7 + 2x24AWG7, UL recognised: AWM</p>	<p>Cable for flexible use in harsh environments, 1x2x28AWG7 + 2x28AWG7, UL and CSA recognised: AWM</p>	Application
<p>Screened pair 02YS(ST) 2x0.31/0.8 VZN Stranded tinned copper wire 7x0.1 mm (0.004 in), Ø 0.3 mm (0.012 in), insulation of foamed PE with skin Ø 0.8 mm (0.031 in), 2 wires twisted to a pair, 2 tinned copper drain wires Ø 0.2 mm (0.008 in), alulamine foil overlapped</p> <p>Wire LIY 1 × 0.14/0.8 VZN Stranded tinned copper wire 7x0.16 mm (0.006 in), Ø 0.48 mm (0.019 in), insulation of PVC Ø 0.78 mm (0.031 in)</p>	<p>Wire LI2Y 0.22/1.1 VZN Stranded tinned copper wire 7x0.2 mm (0.005 in), Ø 0.6 mm (0.024 in), insulation of PE Ø 1.1 mm (0.043 in)</p> <p>Pair LI2Y 2 × 0.09/0.75 VZN (USB 2.0) Wire, stranded tinned copper wire 7x0.13 mm (0.005 in), Ø 0.39 mm (0.015 in), insulation of PE Ø 0.75 mm (0.033 in), 2 wires twisted to a pair</p> <p>Parallel pair LI2Y (ST) 2 × 0.09/1.0 VZN (USB 3.0) Wire, stranded tinned copper wire 7x0.13, Ø 0.39 mm (0.015 in), insulation of PE, Ø 1.0 mm (0.039 in), 2 wires parallel, stranded tinned copper drain wire 7 × 0.13, alulamine foil, overlapped, plastic tape, overlapped</p>	<p>Wire LIY 0.09/0.8 Stranded tinned copper wire 7x0.13 mm (0.005 in), Ø 0.4 mm (0.016 in), insulation of PE Ø 0.8 mm (0.033 in)</p> <p>Pair LI2Y 2x0.09/0.8 (USB) Stranded tinned copper wire 7x0.13 mm (0.005 in), Ø 0.4 mm (0.016 in), insulation of PVC Ø 0.84 mm (0.031 in), 2 wires twisted to a pair</p>	Conductor
<p>2 screened pairs twisted, 2 wires, alulamine foil overlapped</p>	<p>2 parallel pairs, 1 pair, 2 wires and fillers, alulamine foil overlapped</p>	<p>1 pair twisted, 2 wires, alulamine foil overlapped, stranded tinned copper drain wire 0.09 mm² (0.004 square in)</p>	Core
<p>Shield braiding of tinned copper wires Ø 0.1 mm (0.004 in)</p>	<p>Shield braiding of tinned copper wires Ø 0.13 mm (0.005 in)</p>	<p>Shield braiding of tinned copper wires Ø 0.13 mm (0.005 in)</p>	Shield
<p>Thermoplastic Polyurethane (TPU) black Ø 5.2 ± 0.2 mm (0.205 ± 0.008 in)</p>	<p>Thermoplastic Polyurethane (TPU) black Ø 5.7 ± 0.2 mm (0.224 ± 0.008 in)</p>	<p>Thermoplastic Polyurethane (TPU) black Ø 4.2 ± 0.2 mm (0.165 ± 0.008 in)</p>	Jacket
<p>Oil resistant acc. to UL 758 Sec. 15 (60°C, 140 °F), UL-Style 20350</p>	<p>Halogen free acc. to IEC 60754, UL-Style 20963</p>	<p>Oil resistant acc. to UL 758 Sec. 15 (60°C, 140 °F), UL-Style 20963, CSA C22.2 No. 201.2 I/II A/B FT1</p>	Characteristics
<p>02YS (ST) 2x2x0.31/0.8-110 LI PIMF LIY (ST)C11Y 2x1x0.14 VZN BK</p>	<p>LI2Y 2x2x0.09/1.0 VZN PPIMF LI2Y 1x2x0.09/0.75 VZN LI2Y (ST)C11Y 2x1x0.22/1.1 VZN BK</p>	<p>LI2Y 1x2x0.09 LIY (ST)C11Y 2x1x0.09 VZN BK</p>	Type designation
<p>L45467-Y13-W18</p>	<p>L45468-J13-B8</p>	<p>L45581-A49-W18</p>	Order number

FieldLink MC[®] for Motion Control

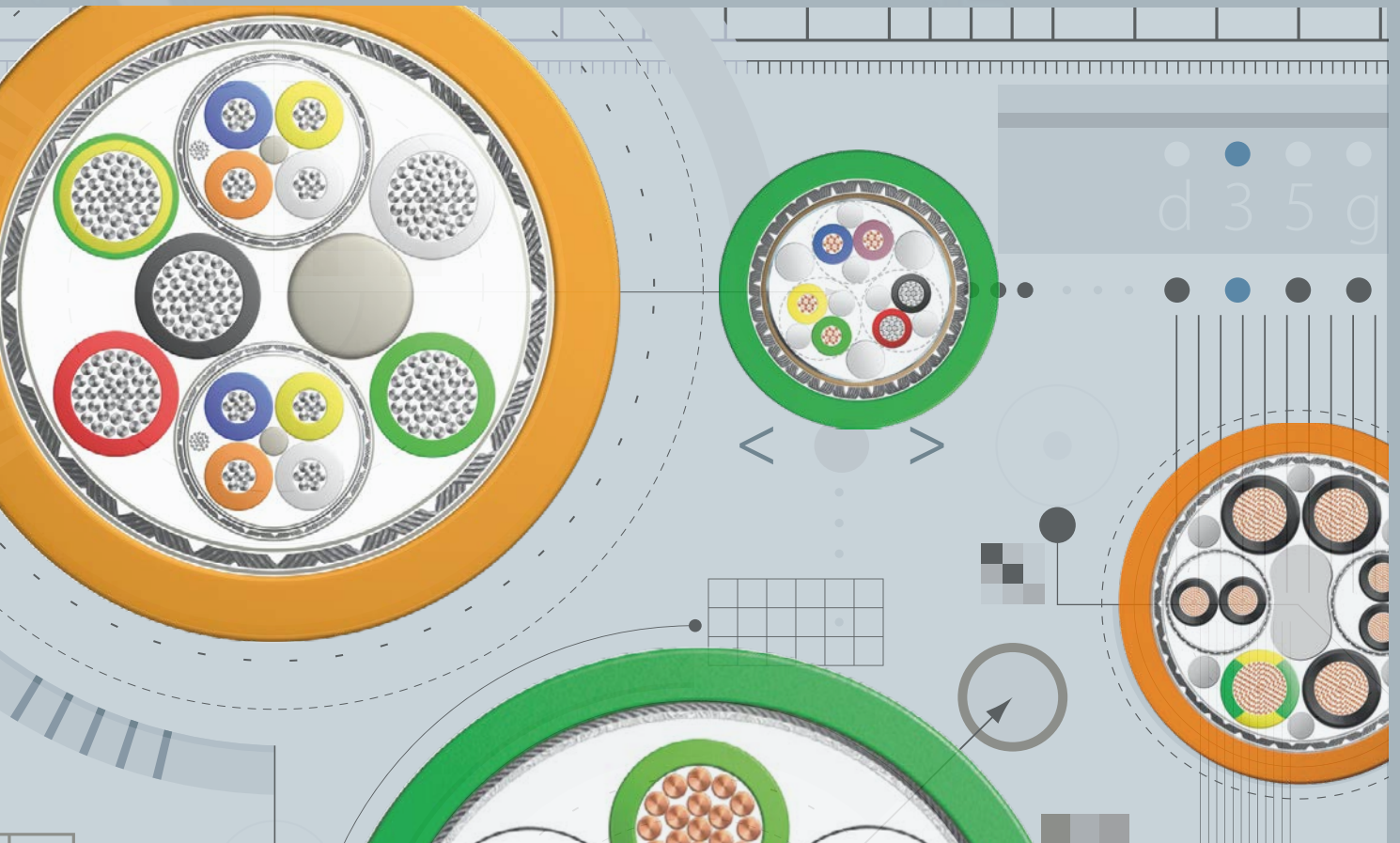

● In drive technology, the trend is towards ever more complex cable systems and fully cabled modules. The quantity of data and speed of transmission are simultaneously rising rapidly. Interference-proof, fixed and dragline-compatible feedback and power cables are required. In addition, harsh industrial environments require extremely robust, permanently flexible cables that are long-lasting and reliable under high mechanical loads.

LEONI provides cables and cable systems for motion-controlled drive mechanisms in machine tools (MC = motion control) under the brand name FieldLink MC. LEONI is able to meet the market's requirements through a smaller outer diameter, application-oriented cable assemblies and the use of special materials.

Feedback cables for Motion Control



Feedback cables for Motion Control enable the information supply of any drive in a factory. The Business Unit Automation & Drives provides all current feedback cable types for up to date motion control standards and standardisation according to UL, CSA and DESINA.

FieldLink MC feedback cables provide the connected drive with the necessary data and programming of its potential. They also provide the information for positioning and control of the drive's actuation.

Assembly Information:

The FieldLink MC product range provides cable system solutions optimised for drive technology with a large number of precisely harmonised components, reduced process costs as well as easy, safe and rapid installation. FieldLink MC cable systems consist of assembled, disruption-resistant LEONI feedback, power and hybrid cords for fixed installation or use in drag chains.

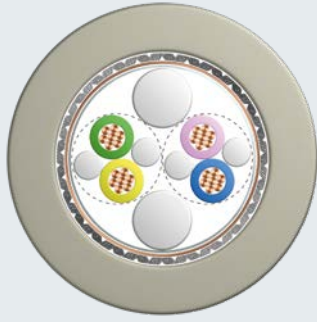
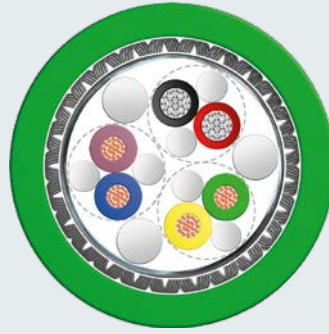

Using our **product finder** you can find appropriate solutions for your application.

**Digital feedback cable****Digital feedback cable****Digital feedback cable**

Application	Cable for permanent installation and flexible applications with low mechanical stress 2x2x0.22	Cable for permanent installation and flexible applications with low mechanical stress 2x2x0.22 + 2x0.38	Cable for flexible installation and very high temperature range 2x2x0.18 + 2x0.38
Conductor	Stranded bare copper wire, insulation of foamed PE with skin, wire identification by colour	Stranded bare and tinned copper wire, insulation of modified PE, wire identification by colour	Stranded tinned copper wire, insulation of FEP, wire identification by colour
Core	Twisted to pairs, pairs twisted with fillers in gaps, foil	Twisted to pairs, pairs twisted with fillers in gaps, foil	Twisted to pairs, pairs twisted with fillers in gaps
Shield	Copper foil overlapped, shield braiding of tinned copper wires, covering $\geq 90\%$	Aluminated foil overlapped, shield braiding of tinned copper wires, covering $\geq 85\%$	Aluminated foil overlapped, shield braiding of tinned copper wires, covering $\geq 85\%$
Jacket	PVC grey	PVC green	Perfluoroethylene propylene (FEP) green
Characteristics	Very good EMC performance, flame retardant and self-extinguishing acc. to 60332-1-2, oil resistant acc. to DIN EN 60811-1-1/2-1, (7x24h, 100°C, 212°C), also available as cable assembly	Very good EMC performance, flame retardant and self-extinguishing acc. to 60332-1-2, oil resistant acc. to DIN EN 60811-1-1/2-1, (7x24h, 100°C, 212°C), also available as cable assembly	Very good EMC performance, flame retardant and self-extinguishing acc. to IEC 60332-1-1 to 1-3, oil resistant acc. to EN 60811-2-1 (7x24h, 90°C, 194°C), also available as cable assembly
Type designation	LI02YS(ST)CY 2x20.22/1.04-100 GR	LI02YS 2x2x0.22/1.04-100 LI2Y (ST)CY 1x2x0.38 VZN GN	LI6Y 2x2x0.18/1.03-100 VZN LI6Y (ST)C6Y 1x2x0.38 VZN GN
Order number	L45467-J216-C5	L45467-J317-C15	L45467-J315-G7

			
Digital feedback cable	Digital feedback cable	Digital feedback cable	
Cable for flexible installation in offshore applications with higher oil res. acc. to NEK606 (FRNC) 2x2x0.22 + 2x0.38	Cable for flexible installation with high mechanical stress 2x2x0.2 + 2x0.38	Cable for flexible installation with high mechanical stress and higher temperature range 2x2x0.18 + 2x0.38	Application
Stranded bare and tinned copper wire, insulation of modified PE, wire identification by colour	Stranded bare and tinned copper wire insulation of modified PE, wire identification by colour	Stranded tinned copper wire insulation of FEP, wire identification by colour	Conductor
Twisted to pairs, pairs twisted with fillers in gaps, foil	Twisted to pairs, pairs twisted with fillers in gaps, foil	Twisted to pairs, pairs twisted with fillers in gaps	Core
Copper foil overlapped, shield braiding of tinned copper wires, covering ≥ 85 %	Alulaminated foil overlapped, shield braiding of tinned copper wires, covering ≥ 85 %	Alulaminated foil overlapped, shield braiding of tinned copper wires, covering ≥ 85 %	Shield
Thermoplastic copolymer (FRNC) green	TPU green	TPU green	Jacket
Very good EMC performance, flame retardant and self-extinguishing acc. to IEC 60332-3-24, halogen free acc. to IEC 60754, mud resistant acc. to NEK606, also available as cable assembly	High endurance, trailing applicable, very good EMC performance, flame retardant and self-extinguishing acc. to IEC 60332-1-2 to 1-3, halogen free acc. to IEC 60754, oil resistant acc. to DIN VDE 0282 Part 10, also available as a cable assembly	High endurance, trailing applicable, very good EMC performance, flame retardant and self-extinguishing acc. to IEC 60332-1-2 to 1-3, halogen free acc. to IEC 60754, oil resistant acc. to DIN VDE 0282 Part 10, also available as a cable assembly	Characteristics
LI02YS 2x2x0.22/1.04-100 LI2Y (ST)CH 1x2x0.38 VZN GN	LI2Y 2x2x0.2/1.3-100 LI2Y (ST)C(ST)11Y 1x2x0.38 VZN GN	LI6Y 2x2x0.18/1.03-100VZN LI6Y(ST)C11Y 1x2x0.38 VZN GN	Type designation
L45467-J317-C6	L45467-J317-B8	L45467-J315-G8	Order number

FieldLink® MC analog feedback cable

for permanent installation and flexible applications with low mechanical stress

DESINA

RoHS 2

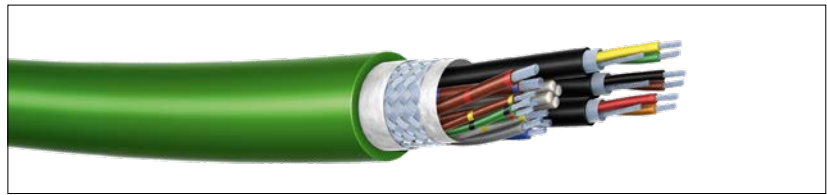

- Very good EMC performance
- Flame retardant and self-extinguishing acc. to IEC 60332-1-2
- Oil resistant acc. to DIN VDE 0281 Part 1 (TM5) (HD 21.1)
- Also available as cable assembly

All feedback cables are available for marine and offshore applications, e.g. with a special SHF1, SHF2, mud resistant or special armoured outer jacket.

See the following example:



Application:

Feedback cable for flexible installation in offshore applications with higher oil resistance acc. to NEK606 (FRNC)

Type designation:

LI9Y2Y 3x2x0.14 (D)
 LI9Y 1x4x0.14
 LI9Y 1x4x0.22
 LI9Y CH 1x2x0.5 VZN GN

Order No.

L45551-W169-K6

All technical details can be found in our product data base:



Cable construction

Conductor	Stranded bare and tinned copper wire, insulation of modified PP, wire identification by colour
Core	Partly twisted to pairs, spinning of tinned copper wires (covering $\geq 90\%$), tinned copper drain wire, foils overlapped, insulation of PE; pairs and wires twisted in layer with fillers in gaps and central filler, fleece foil overlapped
Shield	Shield braiding of tinned copper wires (covering $\geq 85\%$)
Jacket	PVC green acc. to RAL 6018

Technical data

Nominal voltage	30 V
Test voltage	500 V
Minimum bending radius allowed	5 x outer diameter (single), 12 x outer diameter (repeated)
Maximum acceleration	2 m/s ² (6.56 ft/s ²)
Process velocity	180 m/min (590.55 ft/min)
Bendings	2,000,000 at ≥ 12 x outer diameter
Torsion	$\leq \pm 30^\circ/\text{m}$ ($\leq \pm 3.82^\circ/\text{ft}$)
Temperature range	- 20 °C to + 80 °C (- 4 °F to + 176 °F) fixed installation, + 0 °C to + 60 °C (+ 32 °F to + 140 °F) repeated + 150 °C (+ 302 °F) short-time (≤ 1 s)

	Dimensions*	Number of wires	Order number
	(12x0.22 mm ²)	12	L45551-A121-K5
	(2x2x0.18 mm ²)	4	L45581-E41-K125
	(4x2x0.18 mm ²)	8	L45551-A42-K5
	(8x2x0.18 mm ²)	16	L45581-E82-K5
	(4x2x0.14 mm ² + 4x0.5 mm ²)	12	L45551-W129-K55
	(4x2x0.34 mm ² + 4x0.5 mm ²)	12	L45551-W129-K45
	(5x2x0.14 mm ² + 2x0.5 mm ²)	12	L45551-W79-K5
	(5x2x0.14 mm ² + 2x0.5mm ²)	8	L45551-W42-K5
	(3x (2x0.14 mm ²) + 2x(0.5 mm ²))	8	L45551-W89-K5
	(3x (2x0.14 mm ²) + 4x0.14 mm ² + 4x0.22 mm ² + 2x0.5 mm ²)	16	L45551-W169-K15
	(3x (2x0.14 mm ²) + 4x0.14 mm ² + 2x0.5 mm ²)	12	L45551-W129-K35

*additional dimensions available on request

FieldLink® MC analog feedback cable

for flexible installation with high mechanical stress

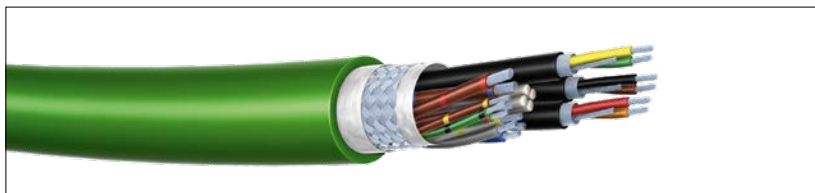

- High endurance
- Trailing applicable
- Very good EMC performance
- Flame retardant and self-extinguishing acc. to IEC 60332-1-2
- Halogen free acc. to IEC 60754
- Oil resistant acc. to DIN VDE 0282 Part 10
- Also available as cable assembly

Cable construction

Conductor	Stranded bare and tinned copper wire, insulation of modified PP, wire identification by colour
Core	Partly twisted to pairs, spinning of tinned copper wires (covering $\geq 90\%$), tinned copper drain wire, foils overlapped, insulation of PE; pairs and wires twisted in layer with fillers in gaps and central filler, fleece foil overlapped
Shield	Shield braiding of tinned copper wires (covering $\geq 85\%$)
Jacket	TPU green acc. to RAL 6018

Technical data

Nominal voltage	30 V
Test voltage	500 V
Minimum bending radius allowed	4 x outer diameter (single), 7.5 x outer diameter (repeated)
Maximum acceleration	20 m/s ² (65.62 ft/s ²)
Process velocity	300 m/min (984.25 ft/min)
Bendings	10,000,000 at ≥ 7.5 x outer diameter
Torsion	$\leq \pm 30^\circ/\text{m}$ ($\leq \pm 3.28^\circ/\text{ft}$)
Temperature range	- 50 °C to + 80 °C (- 58 °F to + 176 °F) storage, - 20 °C to + 60 °C (- 4 °F to + 140 °F) repeated, + 150 °C (+ 302 °F) short-time (≤ 1 s)

	Dimensions*	Number of wires	Order number
	(12x0.22 mm ²)	12	L45551-A121-K18
	(2x2x0.18 mm ²)	4	L45581-E41-K18
	(4x2x0.18 mm ²)	8	L45551-A42-K18
	(8x2x0.18 mm ²)	16	L45581-E82-K18
	(4x2x0.14 mm ² + 4x0.5 mm ²)	12	L45551-W129-K48
	(4x2x0.34 mm ² + 4x0.5 mm ²)	12	L45551-W129-K28
	(10x0.14 mm ² + 2x0.5 mm ²)	12	L45551-W79-K8
	(5x2x0.14 mm ² + 2x0.5 mm ²)	8	L45551-W42-K8
	(3x (2x0.14 mm ²) + 2x0.5 mm ²)	8	L45551-W89-K18
	(3x (2x0.14 mm ²) + 4x0.14 mm ² + 4x0.22 mm ² + 2x0.5 mm ²)	16	L45551-W169-K18
	(3x (2x0.14 mm ²) + 4x0.14 mm ² + 2x0.5 mm ²)	12	L45551-W129-K38
	3x (2x0.14 mm ² + 2x0.34 mm ²)	8	L45551-W42-K28

*additional dimensions available on request

FieldLink® MC feedback cable

for permanent installation and flexible application and applications with low mechanical stress

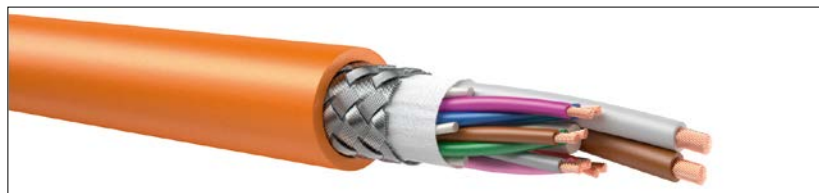

RoHS 2



- Very good EMC performance
- Flame retardant and self-extinguishing acc. to IEC 60332-1-2
- Oil resistant acc. to DIN VDE 0281 Part 1 (TM5) (HD 21.1)
- Also available as cable assembly

Cable construction	
Conductor	Stranded bare copper wire, insulation of modified PP, wire identification by colour
Core	Pairs and wires twisted in layer with fillers in gaps and central filler, fleece foil overlapped
Shield	Shield braiding of tinned copper wires (covering ≥ 85 %), tinned copper drain wire
Jacket	PVC orange acc. to RAL 2003

Technical data	
Nominal voltage	300 V
Test voltage	1,500 V
Minimum bending radius allowed	5 x outer diameter (single), 12 x outer diameter (repeated)
Maximum acceleration	2 m/s ² (6.56 ft/s ²)
Process velocity	180 m/min (590.55 ft/min)
Bendings	2,000,000 at ≥ 12 x outer diameter
Torsion	≤ ± 30°/m (≤ ± 3.28°/ft)
Temperature range	- 20 °C to + 80 °C (- 4 °F to + 176 °F) fixed installation, + 0 °C to + 60 °C (+ 32 °F to + 140 °F) repeated, + 150 °C (+ 302 °F) short-time (≤ 1 s)

	Dimensions*	Outer Diameter	Order number
	(5x2x0.14 mm ² + 2x0.5 mm ²)	7.8 mm (0.31 in)	L45551-W79-K15
	(4x2x0.25 mm ² + 2x0.5 mm ²)	7.99 mm (0.31 in)	L45551-W69-K5
	(4x2x0.25 mm ² + 2x1.0 mm ²)	8.7 mm (0.34 in)	L45551-W69-K15

FieldLink® MC feedback cable

for flexible installation with high mechanical stress

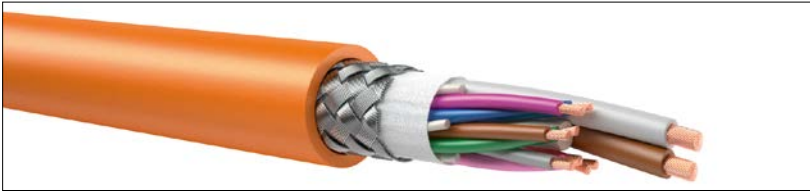

RoHS 2





Cable construction

Conductor	Stranded bare copper wire, insulation of modified PP, wire identification by colour
Core	Pairs and wires twisted in layer with fillers in gaps and central filler, fleece foil overlapped
Shield	Shield braiding of tinned copper wires (covering $\geq 85\%$), tinned copper drain wire
Jacket	TPU orange acc. to RAL 2003

Technical data

Nominal voltage	300 V
Test voltage	1,500 V
Minimum bending radius allowed	4 x outer diameter (single), 7.5 x outer diameter (repeated)
Maximum acceleration	20 m/s ² (65.62 ft/s ²)
Process velocity	300 m/min (984.25 ft/min)
Bendings	10,000,000 at ≥ 7.5 x outer diameter
Torsion	$\leq \pm 30\%$ /m ($\leq \pm 3.28\%$ /ft)
Temperature range	- 50 °C to +80 °C (- 58 °F to +176 °F) storage, - 20 °C to +60 °C (- 4 °F to +140 °F) repeated, +150 °C (+302 °F) short-time (≤ 1 s)

- High endurance
- Trailing applicable
- Very good EMC performance
- Flame retardant and self-extinguishing acc. to IEC 60332-1-2
- Oil resistant acc. to DIN VDE 0282 Part 10
- Halogen free acc. to IEC 60754
- Also available as cable assembly

Dimensions*	Outer Diameter	Order number	
(5x2x0.14 mm ² + 2x0.5 mm ²)	7.8 mm (0.31 in)	L45551-W79-K18	
(4x2x0.25 mm ² + 2x0.5 mm ²)	8.2 mm (0.32 in)	L45551-W69-K8	
(4x2x0.25 mm ² + 2x1.0 mm ²)	8.7 mm (0.34 in)	L45551-W69-K18	

*additional dimensions available on request

Power cables for Motion Control



FieldLink MC power cables are highly flexible and designed for either the single power supply of drives or the additional signal transmission via one or two twisted pair elements for brakes or thermal sensors.

They are standardised according to UL, CSA and DESINA and are highly EMC compatible as well as insusceptible to electrical interferences.

The cables are available for flexible and trailing applications optional with brakes and thermistor.



Using our **product finder** you can find appropriate solutions for your application.

FieldLink® MC power cable

for permanent installation and flexible applications
with low mechanical stress

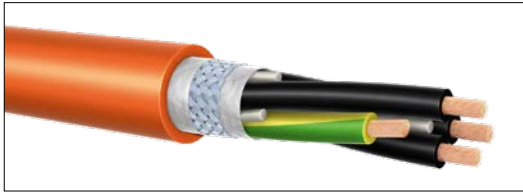

DESINA

RoHS 2



- Very good EMC performance
- Flame retardant and self-extinguishing acc. to IEC 60332-1-2
- Oil resistant acc. to DIN VDE 0281 Part 1 / HD 21.1
- Also available as cable assembly

Cable construction

Conductor	Stranded bare copper wire acc. to IEC 60228, wire identification V/L2, U/L1/C/L+, W/L3/D/L-, GNYE
Core	Four wires twisted in layers with fillers in gaps
Shield	Shield braiding of tinned copper wires (covering $\geq 85\%$)
Jacket	PVC orange acc. to RAL 2003

Technical data

Nominal voltage	0.6 / 1 kV (DIN VDE), 1000 V (UL / CSA)
Test voltage	4 kV 50Hz AC
Minimum bending radius allowed	5 x outer diameter (single), 20 x outer diameter (repeated)
Maximum acceleration	2 m/s ² (6.56 ft/s ²)
Process velocity	30 m/min (98.43 ft/min)
Bendings	100,000 at ≥ 20 x outer diameter
Torsion	$\leq \pm 30^\circ/\text{m}$ ($\leq \pm 3.28^\circ/\text{ft}$)
Horizontal length	max. 5 m (max. 16.40 ft)
Temperature range	-20 °C to +80 °C (-4 °F to +176 °F) fixed installation, +0 °C to +60 °C (+32 °F to +140 °F) repeated, +150 °C (+302 °F) short-time (≤ 1 s)

Dimensions*	Outer diameter	Order number
(4x1.50 mm ²)	8.0 mm (0.31 in)	LEC 003344
(4x2.50 mm ²)	9.6 mm (0.38 in)	LEC 003346
(4x4.00 mm ²)	11.0 mm (0.43 in)	LEC 003348
(4x6.00 mm ²)	13.1 mm (0.52 in)	LEC 003350
(4x10.00 mm ²)	19.5 mm (0.77 in)	LEC 003352
(4x16.00 mm ²)	23.5 mm (0.93 in)	LEC 003354

FieldLink® MC power cable

for flexible installation with high mechanical stress

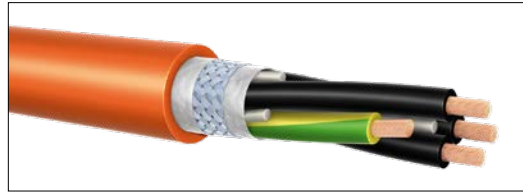

DESINA

RoHS 2



- High endurance
- Trailing applicable
- Very good EMC performance
- Flame retardant and self-extinguishing acc. to IEC 60332-1-2
- Oil resistant acc. to DIN VDE 0282 Part 10 / HD 22.10
- Halogen free acc. to IEC 60754
- Also available as cable assembly

Cable construction

Conductor	Stranded bare copper wire acc. to IEC 60228 Cl. 6, wire identification V/L2, U/L1/C/L+, W/L3/D/L-, GNYE
Core	Four wires twisted in layers with fillers in gaps
Shield	Shield braiding of tinned copper wires (covering $\geq 85\%$)
Jacket	TPU orange acc. to RAL 2003

Technical data

Nominal voltage	0.6 / 1 kV (DIN VDE), 1000 V (UL / CSA)
Test voltage	4 kV 50 Hz AC
Minimum bending radius allowed	5 x outer diameter (single), 7.5 x outer diameter (repeated) for wire dimension ≤ 16 mm ² , 10 x outer diameter (repeated) for wire dimension ≥ 25 mm ²
Maximum acceleration	50 m/s ² (164 ft/s ²)
Process velocity	300 m/min (984.25 ft/min)
Bendings	10,000,000 at ≥ 7.5 x / 10 x outer diameter
Torsion	$\leq \pm 30^\circ/\text{m}$ ($\leq \pm 3.28^\circ/\text{ft}$)
Horizontal length	max. 50 m (max. 164 ft)
Temperature range	-50 °C to +80 °C (-58 °F to +176 °F) fixed installation, -20 °C to +60 °C (-4 °F to +140 °F) repeated, +150 °C (+302 °F) short-time (≤ 1 s)

Dimensions*	Outer diameter	Order number
(4x1.50 mm ²)	10.0 mm (0.39 in)	LEC 003713
(4x2.50 mm ²)	11.7 mm (0.46 in)	LEC 003715
(4x4.00 mm ²)	12.8 mm (0.50 in)	LEC 003717
(4x6.00 mm ²)	15.0 mm (0.59 in)	LEC 003719
(4x10.00 mm ²)	18.5 mm (0.73 in)	LEC 003721
(4x16.00 mm ²)	22.0 mm (0.87 in)	LEC 003723

FieldLink® MC power cable

for permanent installation and flexible applications with low mechanical stress

DESINA

RoHS 2

UL US

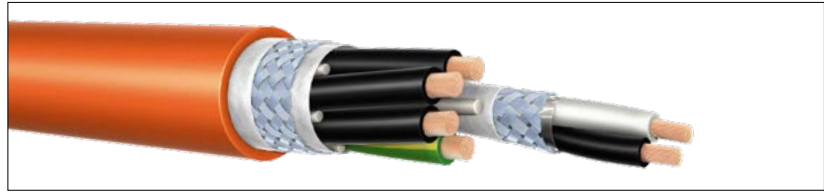

- Very good EMC performance
- Flame retardant and self-extinguishing acc. to IEC 60332-1-2
- Oil resistant acc. to DIN VDE 0281 Part 1 / HD21.1
- Also available as cable assembly

Cable construction

Conductor	Stranded bare copper wire acc. to IEC 60228, wire identification power: V/L2, U/L1/C/L+, W/C3/D/L-, GNYE, signal: black, white
Core	Signal wires: twisted to pairs, braiding of tinned copper wires (covering $\geq 85\%$); pair and four wires twisted in layer with fillers in gaps and central filler
Shield	Shield braiding of tinned copper wires (covering $\geq 85\%$)
Jacket	PVC orange acc. to RAL 2003

All power cables are available for marine and offshore applications, e.g. with a special SHF1, SHF2, mud resistant or special armoured outer jacket.

See the following example:



Application:

Power cable for flexible installation in offshore applications with higher oil res. acc. to NEK606 (FRNC)

Type designation:

LI9Y 1x2x1.5 (C)
LI9Y-J CH 1x4x1.5 OG

Order No.

L45551-F59-K6

All technical details can be found in our product data base:



Technical data

Nominal voltage	0.6 / 1 kV for power and 24 V for signal (DIN VDE), 1,000 V for power and signal (UL / CSA)
Test voltage	4 kV 50 Hz AC
Minimum bending radius allowed	5 x outer diameter (single), 20 x outer diameter (repeated)
Maximum acceleration	2 m/s ² (6.56 ft/s ²)
Process velocity	30 m/min (98.43 ft/min)
Bendings	100,000 at ≥ 20 x outer diameter
Torsion	$\leq \pm 30^\circ/\text{m}$ ($\leq \pm 3.28^\circ/\text{ft}$)
Horizontal length	max. 5 m (max. 16.40 ft)
Temperature range	- 20 °C to + 80 °C (- 4 °F to + 176 °F) single, + 0 °C to + 60 °C (+ 32 °F to + 140 °F) repeated, + 150 °C (+ 302 °F) short-time (≤ 25 s)

Dimensions*	Outer diameter	Order number
4x1.00 mm ² + (2x0.50 mm ²)	9.6 mm (0.38 in)	LEHC 003363
4x0.75 mm ² + (2x0.50 mm ²)	9.4 mm (0.37 in)	LEHC 004461
4x1.00 mm ² + (2x0.75 mm ²)	10.0 mm (0.39 in)	LEHC 003364
4x1.50 mm ² + (2x0.50 mm ²)	10.0 mm (0.39 in)	LEHC 003365
4x1.50 mm ² + (2x0.75 mm ²)	10.3 mm (0.41 in)	LEHC 003366
4x1.50 mm ² + (2x1.00 mm ²)	10.4 mm (0.41 in)	LEHC 003057
4x1.50 mm ² + (2x1.50 mm ²)	10.5 mm (0.41 in)	LEC 003345
4x2.50 mm ² + (2x0.50 mm ²)	11.5 mm (0.45 in)	LEHC 003367
4x2.50 mm ² + (2x0.75 mm ²)	11.8 mm (0.46 in)	LEHC 003368
4x2.50 mm ² + (2x1.00 mm ²)	12.0 mm (0.47 in)	LEHC 003369
4x2.50 mm ² + (2x1.50 mm ²)	12.0 mm (0.47 in)	LEHC 003347
4x4.00 mm ² + (2x1.00 mm ²)	13.4 mm (0.53 in)	LEHC 003370
4x4.00 mm ² + (2x1.50 mm ²)	13.5 mm (0.53 in)	LEHC 003349
4x6.00 mm ² + (2x1.00 mm ²)	15.3 mm (0.60 in)	LEHC 003371
4x6.00 mm ² + (2x1.50 mm ²)	15.6 mm (0.61 in)	LEHC 003351
4x10.00 mm ² + (2x1.00 mm ²)	20.8 mm (0.82 in)	LEHC 003372
4x10.00 mm ² + (2x1.50 mm ²)	21.0 mm (0.83 in)	LEHC 003353
4x16.00 mm ² + (2x1.00 mm ²)	24.0 mm (0.94 in)	LEHC 003373
4x16.00 mm ² + (2x1.50 mm ²)	24.1 mm (0.95 in)	LEHC 003355

FieldLink® MC power cable

for flexible installation with high mechanical stress

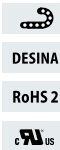
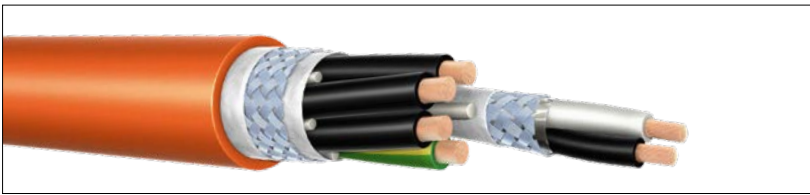

Cable construction

Conductor	Stranded bare copper wire acc. to IEC 60228 Cl. 6, wire identification power: U/L1/C/L+, V/L2, W/L3/D/L-, GNYE, signal: black, white
Core	Signal wire: twisted to pair, braidings of tinned copper wires (covering $\geq 85\%$); pair and four wires twisted in layer with fillers in gaps and central filler
Shield	Shield braiding of tinned copper wires (covering $\geq 85\%$)
Jacket	TPU orange acc. to RAL 2003

Technical data

Nominal voltage	0.6 / 1 kV for power and 24 V for signal (DIN VDE), 1,000 V for power and signal (UL / CSA)
Test voltage	4 kV 50 Hz AC
Minimum bending radius allowed	5 x outer diameter (single), 7.5 x outer diameter (repeated) for wire dimension $\leq 16 \text{ mm}^2$, 10 x outer diameter (repeated) for wire dimension $\geq 25 \text{ mm}^2$
Maximum acceleration	50 m/s ² (164 ft/s ²)
Process velocity	300 m/min (984.25 ft/min)
Bendings	10,000,000 at $\geq 7,5 \times / 10 \times$ outer diameter
Torsion	$\leq \pm 30^\circ/\text{m}$ ($\leq \pm 3.28^\circ/\text{ft}$)
Horizontal length	max. 50 m (max. 164 ft)
Temperature range	- 50 °C to + 80 °C (- 58 °F to +176 °F) fixed installation, - 20 °C to + 60 °C (- 4 °F to + 140 °F) repeated, + 150 °C (+ 302 °F) short-time ($\leq 5 \text{ s}$)

- High endurance
- Trailing applicable
- Very good EMC performance
- Flame retardant and self-extinguishing acc. to IEC 60332-1-2
- Oil resistant acc. to DIN VDE 0282 Part 10 / HD 22.10
- Halogen free acc. to IEC 60754
- Also available as cable assembly

Dimensions*	Wires	Outer diameter	Order number
4x1.00 mm ² + (2x0.50 mm ²)	6	10.1 mm (0.40 in)	LEHC 004815
4x1.50 mm ² + (2x0.50 mm ²)	6	10.7 mm (0.42 in)	LEHC 004816
4x1.00 mm ² + (2x1.00 mm ²)	6	10.8 mm (0.43 in)	LEC 004693
4x1.50 mm ² + (2x0.75 mm ²)	6	11.1 mm (0.44 in)	LEHC 004817
4x1.50 mm ² + (2x1.00 mm ²)	6	11.3 mm (0.4 in)	LEHC 004694
4x2.50 mm ² + (2x0.50 mm ²)	6	12.2 mm (0.48 in)	LEHC 004818
4x1.50 mm ² + (2x1.50 mm ²)	6	12.5 mm (0.49 in)	LEC 003714
4x2.50 mm ² + (2x0.75 mm ²)	6	12.6 mm (0.50 in)	LEHC 004819
4x2.50 mm ² + (2x1.00 mm ²)	6	13.0 mm (0.51 in)	LEHC 004695
4x2.50 mm ² + (2x1.50 mm ²)	6	13.8 mm (0.54 in)	LEHC 003716
4x4.00 mm ² + (2x1.00 mm ²)	6	14.4 mm (0.56 in)	LEHC 004696
4x4.00 mm ² + (2x1.50 mm ²)	6	15.0 mm (0.59 in)	LEHC 003718
4x6.00 mm ² + (2x1.00 mm ²)	6	16.5 mm (0.64 in)	LEHC 004697
4x6.00 mm ² + (2x1.50 mm ²)	6	16.7 mm (0.66 in)	LEHC 003720
4x10.00 mm ² + (2x1.00 mm ²)	6	19.0 mm (0.74 in)	LEHC 004698
4x10.00 mm ² + (2x1.50 mm ²)	6	19.5 mm (0.77 in)	LEHC 003722
4x16.00 mm ² + (2x1.00 mm ²)	6	22.8 mm (0.89 in)	LEHC 004699
4x16.00 mm ² + (2x1.50 mm ²)	6	23.2 mm (0.91 in)	LEHC 003724

*additional dimensions available on request

FieldLink® MC power cable

for permanent installation and flexible applications with low mechanical stress



DESINA

RoHS 2

- Very good EMC performance
- Flame retardant and self-extinguishing acc. to IEC 60332-1-2
- Oil resistant acc. to DIN VDE 0281 Part 1 HD 21.1
- Also available as cable assembly

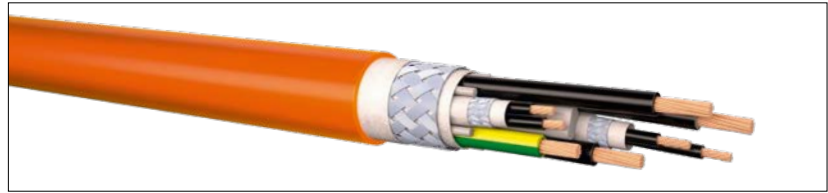

Cable construction

Conductor	Stranded bare copper wire acc. to IEC 60228, wire identification power: black, white with numbers 1, 2, 3, GNYE, signal: 1st pair 5, 6, 2nd pair, 7, 8
Core	Signal wires: twisted to pairs, aluminised foil wrapped, braidings of tinned copper wires (covering $\geq 85\%$); pairs and four wires twisted in layer with fillers in gaps and central filler
Shield	Shield braiding of tinned copper wires (covering $\geq 85\%$)
Jacket	PVC orange acc. to RAL 2003

Technical data

Nominal voltage	0.6 / 1 kV for power and 24 V for signal (DIN VDE), 1,000 V for power and signal (UL / CSA)
Test voltage	4 kV 50 Hz AC
Minimum bending radius allowed	5 x outer diameter (single), 20 x outer diameter (repeated)
Maximum acceleration	2 m/s ² (6.56 ft/s ²)
Process velocity	30 m/min (98.43 ft/min)
Bendings	100,000 at ≥ 20 x outer diameter
Torsion	$\leq \pm 30$ °/m ($\leq \pm 3.28$ °/ft)
Horizontal length	max. 5 m (max. 16.40 ft)
Temperature range	- 20 °C to + 80 °C (- 4 °F to + 176 °F) fixed installation, + 0 °C to + 60 °C (+ 32 °F to + 140 °F) repeated, + 150 °C (+ 302 °F) short-time (≤ 5 s)

Dimensions*	Outer diameter	Order number
4x0.75 mm ² + 2 x (2x0.34 mm ²)	10.6 mm (0.42 in)	LEHC 003378
4x1.00 mm ² + 2 x (2x0.75 mm ²)	12.0 mm (0.47 in)	LEHC 003379
4x1.50 mm ² + 2 x (2x0.75 mm ²)	12.3 mm (0.48 in)	LEHC 003380
4x2.50 mm ² + 2 x (2x0.75 mm ²)	13.8 mm (0.54 in)	LEHC 003381
4x2.50 mm ² + 2 x (2x1.00 mm ²)	14.2 mm (0.56 in)	LEHC 003382
4x4.00 mm ² + (2x1.00 mm ²) + (2x1.50 mm ²)	15.7 mm (0.62 in)	LEHC 003383
4x4.00 mm ² + 2 x (2x1.50 mm ²)	16.0 mm (0.63 in)	LEHC 004726
4x6.00 mm ² + (2x1.00 mm ²) + (2x1.50 mm ²)	17.7 mm (0.70 in)	LEHC 003384
4x10.00 mm ² + (2x1.00 mm ²) + (2x1.50 mm ²)	22.8 mm (0.90 in)	LEHC 003385
4x10.00 mm ² + 2 x (2x1.50 mm ²)	23.0 mm (0.91 in)	LEHC 003386
4x16.00 mm ² + 2 x (2x1.50 mm ²)	26.8 mm (1.06 in)	LEHC 003387

FieldLink® MC power cable

for flexible installation with high mechanical stress

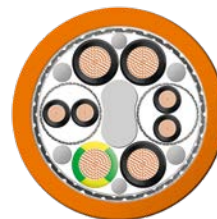
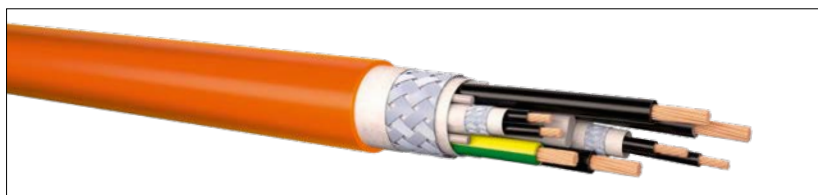

DESINA

RoHS 2



Cable construction

Conductor	Stranded bare copper wire acc. to IEC 60228 Cl. 5 and Cl. 6, wire identification power: black, white with numbers 1, 2, 3, GNYE, signal: 1st pair 5, 6, 2nd pair 7, 8
Core	Signal wires: twisted to pairs, both sides aluminised tape wrapped, braidings of tinned copper wires (covering $\geq 85\%$); pairs and four wires twisted in layer with fillers in gaps and central filler
Shield	Shield braiding of tinned copper wires (covering $\geq 85\%$)
Jacket	TPU orange acc. to RAL 2003

Technical data

Nominal voltage	0.6 / 1 kV for power and 24 V for signal (DIN VDE), 1,000 V for power and signal (UL / CSA)
Test voltage	4 kV 50 Hz AC (wires)
Minimum bending radius allowed	6 x outer diameter (single), 12 x outer diameter (repeated)
Maximum acceleration	5 m/s ² (16.40 ft/s ²)
Process velocity	180 m/min (590.55 ft/min)
Bendings	10,000,000 at ≥ 12 x outer diameter
Torsion	$\leq \pm 30$ °/m ($\leq \pm 3.28$ °/ft)
Temperature range	- 50 °C to + 80 °C (- 58 °F to + 176 °F) fixed installation, - 20 °C to + 60 °C (- 4 °F to + 140 °F) repeated, + 150 °C (+ 302 °F) short-time (≤ 5 s)

- High endurance
- Trailing applicable
- Very good EMC performance
- Flame retardant and self-extinguishing acc. to IEC 60332-1-2
- Oil resistant acc. to DIN VDE 0282 Part 10 / HD 22.10
- Halogen free acc. to IEC 60754
- Also available as cable assembly

Dimensions*	Outer diameter	Order number
4x0.75 mm ² + 2x (2x0.34 mm ²)	10.8 mm (0.43 in)	LEHC 004897
4x1.00 mm ² + 2x (2x0.75 mm ²)	12.0 mm (0.47 in)	LEHC 003981
4x1.50 mm ² + 2x (2x0.75 mm ²)	12.5 mm (0.49 in)	LEHC 003982
4x2.50 mm ² + 2x (2x0.75 mm ²)	13.8 mm (0.54 in)	LEHC 004898
4x2.50 mm ² + 2x (2x1.00 mm ²)	14.7 mm (0.58 in)	LEHC 004899
4x2.50 mm ² + 2x (2x1.50 mm ²)	15.0 mm (0.59 in)	LEHC 004866
4x4.00 mm ² + 2x (2x1.00 mm ²)	16.2 mm (0.64 in)	LEHC 004900
4x4.00 mm ² + (2x1.00 mm ²) + (2x1.50 mm ²)	16.4 mm (0.65 in)	LEHC 004901
4x4.00 mm ² + 2x (2x1.50 mm ²)	16.7 mm (0.66 in)	LEHC 004902
4x6.00 mm ² + (2x1.00 mm ²) + (2x1.50 mm ²)	18.2 mm (0.72 in)	LEHC 004903
4x6.00 mm ² + 2x (2x1.50 mm ²)	18.5 mm (0.73 in)	LEHC 004904
4x10.00 mm ² + (2x1.00 mm ²) + (2x1.50 mm ²)	21.6 mm (0.85 in)	LEHC 004905
4x10.00 mm ² + 2x (2x1.50 mm ²)	22.7 mm (0.90 in)	LEHC 004906
4x16.00 mm ² + 2x (2x1.50 mm ²)	24.6 mm (0.97 in)	LEHC 004907

*additional dimensions available on request

Hybrid cables for Motion Control





FieldLink MC hybrid cables reach new heights in cost efficiency and flexibility. The innovative design combines energy supply and data transfer in one single cable, thereby reducing wiring expenditures by up to 85 %.

The cables withstand 5 up to 10 million bending cycles and significantly increases modularity in machines and systems.



Using our **product finder** you can find appropriate solutions for your application.

			
<p>Hybrid cable</p> <p>Cable with digital feedback channel (DSL) for flexible installation with high mechanical stress 4x2.50 + (2x0.24)</p>	<p>Hybrid cable</p> <p>Cable with digital feedback channel (Cat5e) for flexible installation with high mechanical stress 5x2.50 + (4x0.34)</p>	<p>Hybrid cable</p> <p>Cable with digital feedback channels (2xCat 5e) for flexible installation with high mechanical stress 5x2.50 + 2x (4x0.34)</p>	Application
<p>Power: 2.5 mm² stranded tinned copper wire acc. to IEC 60228 Cl. 6, insulation PP, black, green, yellow, blue and brown</p> <p>Signal (DSL): 0.24 mm² stranded tinned copper wire, insulation PE grey, pink</p>	<p>Power: 2.5 mm² stranded bare copper wire acc. to IEC 60228 Cl. 6, insulation PP, red, black with wire identification 1, 2, green-yellow and blue.</p> <p>Signal (Cat5e): 0.34 mm² stranded tinned copper wire, insulation polyethylene, white, yellow, blue and orange</p>	<p>Power: 2.5 mm² stranded tinned copper wire acc. to IEC 60228 Cl. 6, insulation PP, red, black, green-yellow, white and green</p> <p>Signal (Cat5e): 0.34 mm² stranded tinned copper wire, insulation PE, white, yellow, blue and orange</p>	Conductor
<p>Signal wires: twisted aluminised tape wrapped, braidings of tinned copper wires, covering ≥ 85 %, pair and four wires twisted in layer with fillers in gaps and central filler</p>	<p>Signal wires: twisted to quad, aluminised tape wrapped, braidings of tinned copper wires, covering ≥ 85 %, quad and power wires twisted in layer around the central filler</p>	<p>Signal wires: twisted to quad, aluminised tape wrapped, braidings of tinned copper wires, covering ≥ 85 %, 2x quad and power wires twisted in a layer around the central filler</p>	Core
<p>Shield braiding of tinned copper wires, covering ≥ 85 %</p>	<p>Shield braiding of tinned copper wires, covering ≥ 85 %</p>	<p>Shield braiding of tinned copper wires covering ≥ 85 %</p>	Shield
<p>TPU orange acc. to RAL 2003</p>	<p>TPU orange acc. to RAL 2003</p>	<p>TPU orange acc. to RAL 2003</p>	Jacket
<p>High endurance, trailing applicable, very good EMC performance, flame retardant and self-extinguishing acc. to IEC 60332-1-2, halogen free acc. to IEC 60754, oil resistant acc. to DIN VDE 0282 Part 10, also available as cable assembly</p>	<p>High endurance, trailing applicable, very good EMC performance, flame retardant and self-extinguishing acc. to IEC 60332-1-2, halogen free acc. to IEC 60754, oil resistant acc. to DIN VDE 0282 Part 10, also available as cable assembly</p>	<p>High endurance, trailing applicable, very good EMC performance, flame retardant and self-extinguishing acc. to IEC 60332-1-2, halogen free acc. to IEC 60754, oil resistant acc. to DIN VDE 0282 Part 10, also available as a cable assembly</p>	Characteristics
<p>LI2Y(ST)C 1x2x0.24/1.9-110 VZNLI9Y-J C11Y 4x1x2.5/2.85 VZN OR</p>	<p>2Y(ST)C(ST) 2x2x0.75/1.56-100 LI LI9Y-ZJ C11Y 5x1x2.5 OR</p>	<p>2Y(ST)C 2x4x0.75/1.55-100 LI VZNLI9Y-JC11Y 5x1x2.5 VZN OR</p>	Type designation
<p>L45467-Y516-W8</p>	<p>L45467-J617-W8</p>	<p>L45467-J717-W8</p>	Order number

Technical information

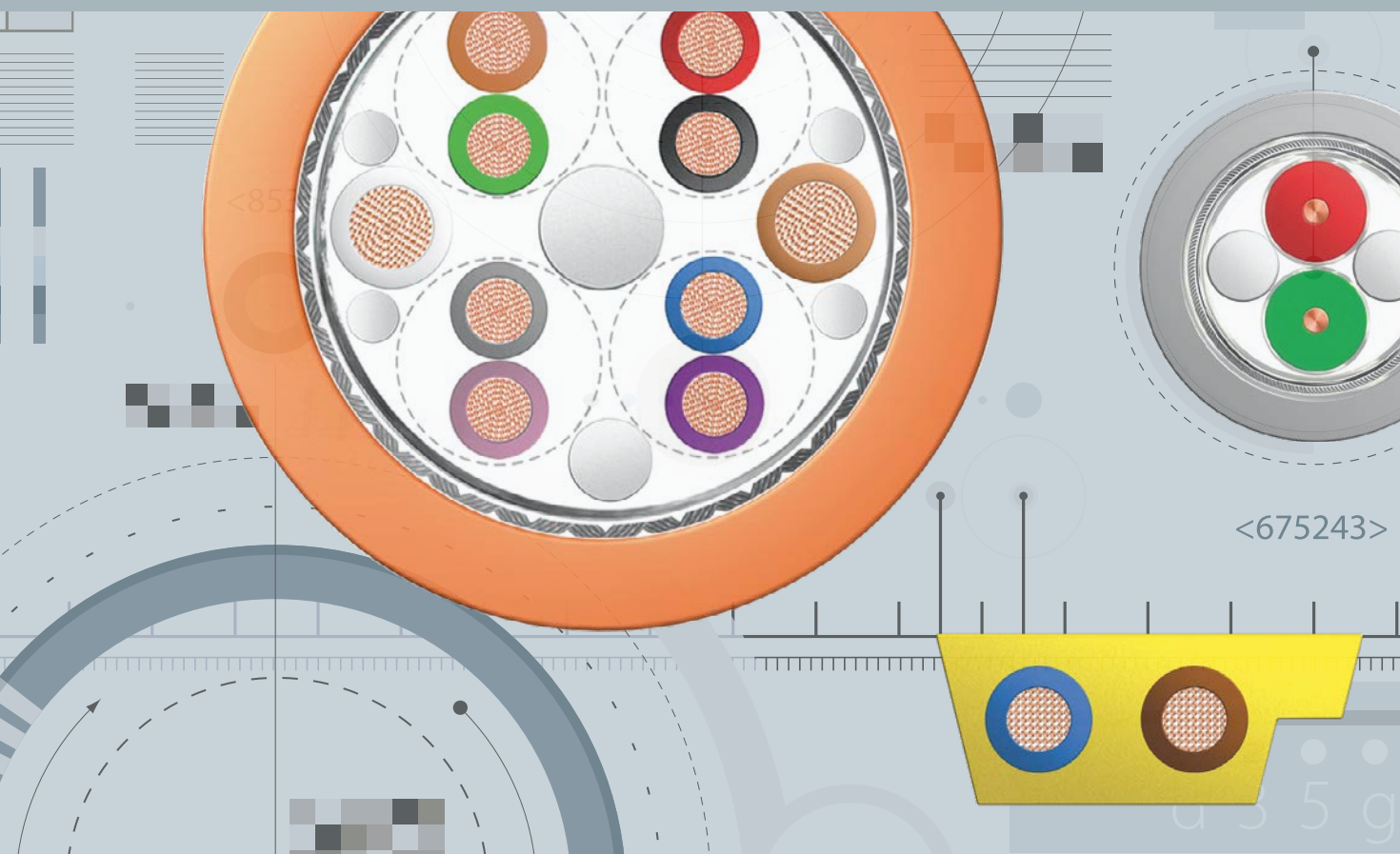

Type designations for copper cables	73
Installation guidelines	74
Test centre	75
The significance of UL and CSA certifications	76
UL listed cable types	78
Flame tests	80
Quality and environment	86
Industrial expertise worldwide	87

Type designations for copper cables

B	armour
(2B...)	two layers of steel tape; thickness of one steel tape in mm
C	screen of copper wire braiding
FE 90	insulation integrity 90 minutes
FLI	flat cable with stranded conductor
FR	improved flame retardant
H	insulation or sheath of halogen-free material
J-	installation cable
-J	grounded wire, green-yellow
... IMF	separate stranding element in metal foil or in metallised paper and sheath wire (e.g. pairs PIMF)
KF ...	cold-proof implementation down to minus ... °C
L	wires with bunched conductor > 0.2 mm ²
LI	cord with stranded conductor < 0.2 mm ²
NC	non corrosivity of combustion gases
OE	oil-proof
(ST)	electrostatic shield made of metal foil or plastic laminated metal foil
VZN	tinned conductor
W	corrugated steel sheath
X	insulation, sheath or protective cover of cross-linked Polyvinylchloride (PVC)
2X	insulation, sheath or protective cover of cross-linked Polyethylene (PE)
11X	insulation, sheath or protective cover of cross-linked Thermoplastic Polyurethane (TPU)
Y	insulation, sheath or protective cover of Polyvinylchloride (PVC)
2Y	insulation, sheath or protective cover of Polyethylene (PE)
9Y	insulation, sheath or protective cover of Polypropylene (PP)
11Y	insulation, sheath or protective cover of Thermoplastic Polyurethane (TPU)
12Y	insulation of Polyethylene Terephthalate
99Y	insulation, sheath or protective cover of all other thermoplastics without VDE symbols
02YS	insulation of cellular Polyethylene (PE) with additional skin of solid material (foam skin)
02Y	insulation of cellular Polyethylene (PE)
-Z	wires with printed numbers

Colour code DIN IEC 60757:

BK	black
BN	brown
RD	red
OG	orange
YE	yellow
GN	green
BU	blue
VT	violet
GY	grey
WH	white
PK	pink
TQ	turquoise
GD	gold
SR	silver

Example: PROFINET cable for permanent installation (see page 12)

Order no.: L45467-J16-B35

2Y Y (ST) C Y 2x2x0.64 / 1.5-100 GN

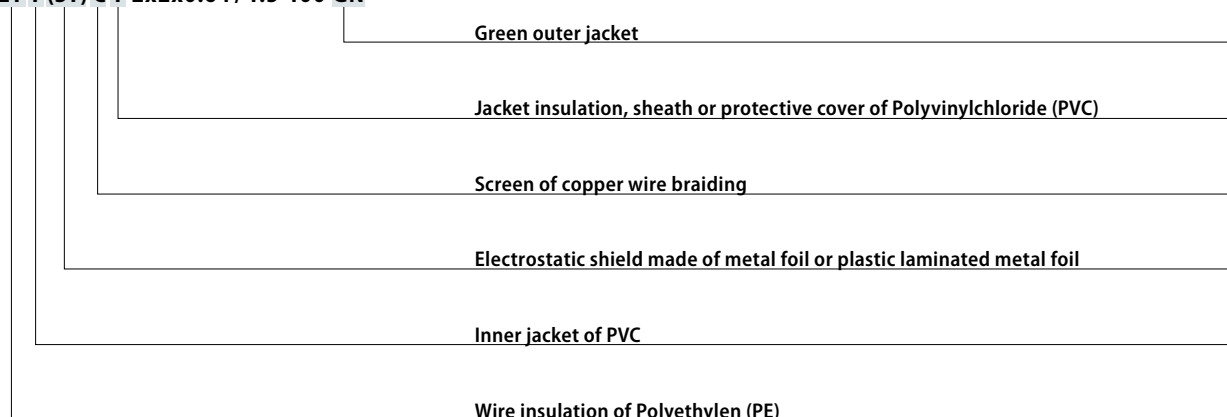

Installation guidelines

Installation guidelines for flexible cables in energy tracking chains

Please abide by the following recommendations for LEONI cables used in energy tracking chains.

- 1.** In order to conserve the high-quality characteristics, storage should be in closed spaces under observance of the temperature thresholds correspondingly stated.
- 2.** To ensure easy installation under optimal mechanical conditions, cables should be stored at room temperature for at least 24 hours before use.
- 3.** Cables should be stored in cable drums until final installation. Repeated winding of the cables onto different reels should be avoided whenever possible.
- 4.** The choice of energy tracking chains must follow the characteristics of the cables in use.
- 5.** The bending radii of the cables must not fall short of the specified values.
- 6.** Installation of the cables in energy tracking chains must be torsion-free. Cables must never be pulled sideways from the drum or ring, but tangentially rolled off immediately before use. If necessary, lay or hang the cables out before use.
- 7.** Within the energy tracking chains, the cables have to be loosely laid out side by side without friction. Freedom of movement must be ensured. Make sure there is free space amounting to at least 10 % of the cable diameter on all sides, without exceeding 50 % in width. For optimal adjustment, place single cables separated by fixed links. Placing cables on top of each other (i.e. without fixed links) should be avoided whenever possible. Cables of different outer diameters and conducting materials should be installed separately.
- 8.** In order to prevent cables from restricting each other's movement, vertically suspended energy tracking chains should allow for free space of at least 20 % of the cable diameter above and below the cable.
- 9.** Cables within an energy tracking chain must retain freedom of movement in the longitudinal direction at all times. Use of fixations and/or guiderails is prohibited. No tensile force is to be effected in the radius.
- 10.** In order to ensure the freedom of movement of the cores, cables must extensively be fixed by the outer jacket at both ends of the energy tracking chains. Movement up to the points of fixation, however, is prohibited. Proximity to the nearest pivot point of the chain is 20 x cable diameter at maximum.
- 11.** After a short period of operation, it is imperative to verify proper cable adjustment (stretching during operation, contortion). Verification checks have to take place after a few completed cycles each. If necessary, return the cables to center position and readjust the cable-length at the entrainer. Make sure the cable does not fly out at the inner or outer radius. Cable adjustment must be rechecked after a few test runs and should be verified every six months.
- 12.** In the event of fracture or other damage to the energy tracking chain, all cables must be replaced. Permanent damage resulting from contortion, indentation or shearing is to be expected.

These guidelines are based on field experience with LEONI cables; they are not grounds for demands of warranty and/or recourse. Please also refer to the installation guidelines provided by the manufacturer of the energy tracking chain.

Test centre

Ensuring long-lasting dynamic requirements



We are always investing in our device equipment to satisfy the needs of our customers. The long-lasting mobility of our cables is tested in various processes in order to prove their long service life.

Drag chain tests

Our test routes have different travel ranges, accelerations and travel speeds. Each test system can test up to 40 cables over the equivalent of several years. The longest traverse path measures 50 m.



Torsion tests

In different torsion and torsional bending machines, the cables are tested for twisting and traction around themselves. They are subjected to a torsional movement of up to $\pm 360^\circ$ in length from 0.3 to 1 meter.

Bending tests

In test systems with rolls for different bending radii, a test is performed to see whether the cable withstands frequent bending cycles. The rolls used have a diameter of 20 to 250 mm.

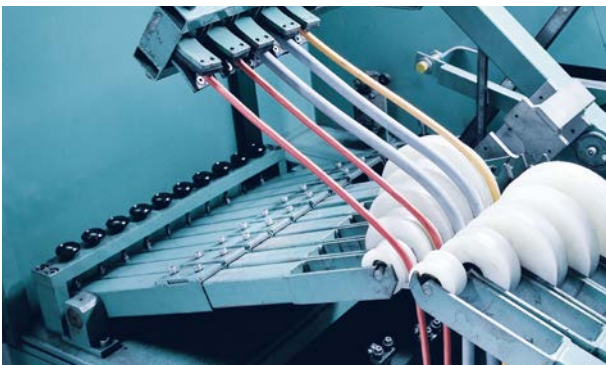

S-shaped bending test

The cable is fed across two bobbins in an s-shaped flex movement. As an option and as required, weights can be fitted to both ends. The line generates up to 12 cycles per minute.









To pass the flex test, the cable may not present any power failure between the cores.



LEONI checks the quality of the cables in their in-house test centre. Discover the competence here.



The significance of UL and CSA certifications

	Approval only for Canada	Approval only for USA	Approval for Canada and USA
The two organisations, UL and CSA International, are recognised in Canada and in the USA. They issue various test marks according to validity.	 	 	 
The test mark (UR) identifies products which are integrated as components in electrical equipment (recognised mark).			

Before electrical products are allowed onto the North American market they have to be tested and certified as to their hazard potential in respect of combustibility, electric shock and – for certain equipment – electromagnetic compatibility.

To comply with product liability laws a manufacturer has to ensure by the testing and certification of his components that they fully satisfy national statutory requirements.

Certification for the USA:

Certifications have to be issued by a Nationally Recognized Testing Laboratory (NRTL). NRTL status is awarded by the Occupational Safety and Health Administration (OSHA).

- e.g.
- UL (Underwriters Laboratories)
 - CSA International (Canadian Standards Association)
 - ITSNA (Intertek Testing Service NA, Inc.)
 - TUV Rheinland of North America

Certification for Canada:

Certifications have to be issued by a qualification office recognised by the Standards Council of Canada (SCC).

- e.g.
- CSA International
 - UL
 - ITSNA

Appliance Wiring Material (AWM)

Appliance wiring material (AWM) is a recognised component. That means that it is used in UL Listed or Classified end products. AWM wires are intended as factory-installed or factory-provided components of complete equipment. The final acceptance of the component depends on its installation and use in or with complete equipment submitted to UL.

Many different constructions of wires and cables make up the AWM category, including single- and multi-conductor types of a wide range of conductor sizes, insulation and jacket materials and uses. Each construction of wire is given a style number with a corresponding style page, used to describe the construction.

The style page includes temperature and voltage ratings, conductor size and material, insulation and jacket materials and thicknesses, shields or coverings and as well as the UL reference standard used to evaluate the wire.

The basic standard used to evaluate AWM is UL 758, the standard for Safety of Appliance Wiring Material. The Canadian standard for appliance wiring material is CSA C22.2 No. 210-11, Appliance Wiring Material Products. The UL Recognised Component Mark may be used on components certified by UL to both Canadian and U.S. requirements. LEONI has more than 700 styles in its procedure of authorised AWM styles.

Flame tests for AWM applications are described in UL 1581, UL 2556 and CSA C22.2 No. 03. Characteristic for these tests is the periodic exposure of the test specimen to flames and the disallowance of the ignition of cotton wool by dripping off glowing particles. The most severe flame test for single cables is the VW-1 test. Any style can be rated and marked VW-1 as long as it meets the requirements in the standard.

UL / CSA Single Cable Flame Tests

Name / class	Standard	Area of use
VW-1 Vertical-Specimen Flame Test	UL 2556 Sec. 9.4	Special applications and „limited use“ acc. to NEC
FT1 Vertical Flame Test	UL 2556 Sec. 9.3 CSA C22.2 No. 03	AWM Class I / Class II (internal/external wiring)
CFT Cable Flame Test	UL 1581 Sec. 1061	AWM Use II (external wiring) (formerly known as Page 95)
H Horizontal Flame Test	UL 1581 Sec. 1090	AWM Use I (internal wiring) (formerly known as Page 31)
FT2 Horizontal Flame Test	UL 2556 Sec. 9.1 CSA C22.2 No. 03	AWM Class I / Class II (internal/external wiring)

UL listed cables types

for fixed wiring in buildings, factory wired equipment and for field wiring

NEC cable substitution hierarchie

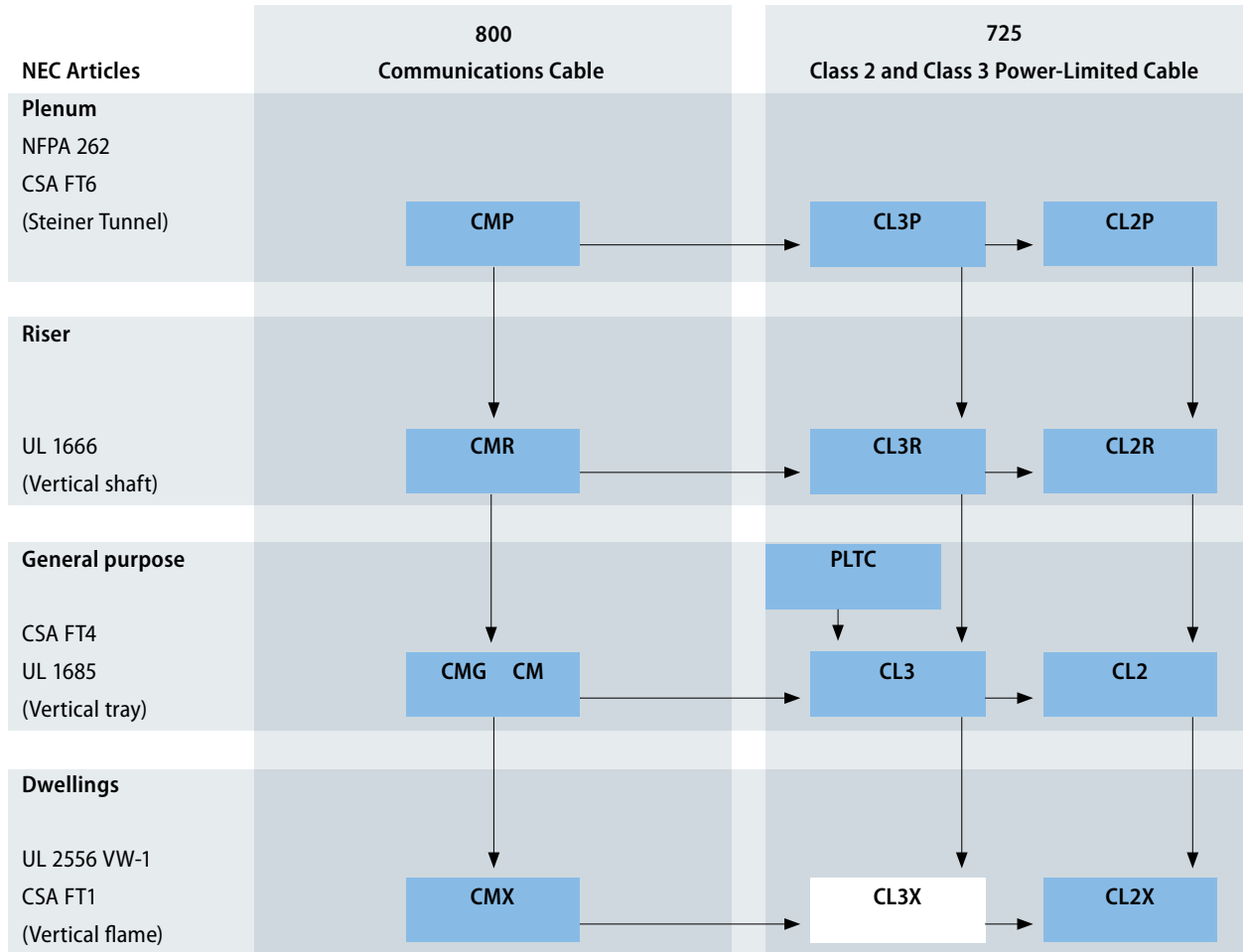

A → **B** Cable A shall be permitted to be used in place of cable B Listed types of LEONI

Cable types	Use	NEC article	UL standard
CMP, CMR, CMG, CM, CMX	Communications cables	800	444
CL3P, CL2P, CL3R, CL2R, CL3, CL2, CL3X, CL2X	Class 2, Class 3 Remote-Control, signaling and power limited cables	725	13
PLTC	Power limited tray cables	725	13

National Electrical Code (NEC)

The NEC is published by the National Fire Protection Association (NFPA) to provide practical protection for persons and property from the risks of using electricity (see also www.nfpa.org). Instructions on how to use cables and wires in various areas (e.g. inside and outside buildings, factories and other premises) are set out in nine chapters. NEC type IDs are abbreviations consisting of a prefix and a suffix. The prefix describes the type of cable (e.g. CM = Communications metallic, CL3=class 3 Power Limited Circuit, OF = Optical Fibre). The suffix indicates the type of mandatory flame test and the area of use (e.g. P = Plenum, R = Riser, X = Limited Use).

Plenum

Cables which are allowed to be used without additional protection in ducts and horizontal spaces above suspended ceilings plenums are called Plenum Cable or Horizontal Cable. The requirements imposed on these cables for "low smoke" and "low flame spread" are very severe. To comply with the NEC, a plenum cable has to pass the Steiner Tunnel flame test in accordance with NFPA 262 FT6. The type ID ends with a P.

Riser

Cables which are installed in risers (vertical shafts) or other cavities linking at least two storeys are called riser cables or backbone cables. Requirements imposed on fire safety are less severe than for plenum cables. A riser cable has to pass the riser flame test in accordance with UL 1666. Its type ID ends with an R.

General purpose

Cables used in areas of buildings which are neither plenums or risers are called general purpose cables. As a minimum requirement they have to pass the vertical tray flame test in accordance with UL 1685 Sec. 4 – UL-version (no ID letter issued). Cables which pass the vertical tray FT 4 test in accordance to UL 1685, Sec. 12 - CSA-version have a G at the end of their ID code.

Dwelling

These types of cable are for limited use inside dwellings. They are identified by the letter X and are required to pass at least the vertical wire flame test VW-1 according to UL 2556. UL listed cables are marked with the NEC type ID which corresponds to the respective UL standard.



UL single cable flame tests

UL 2556 Sec.9.3 FT1 / Sec.9.4 VW-1 / UL 1581 Sec.1061 Cable Flame

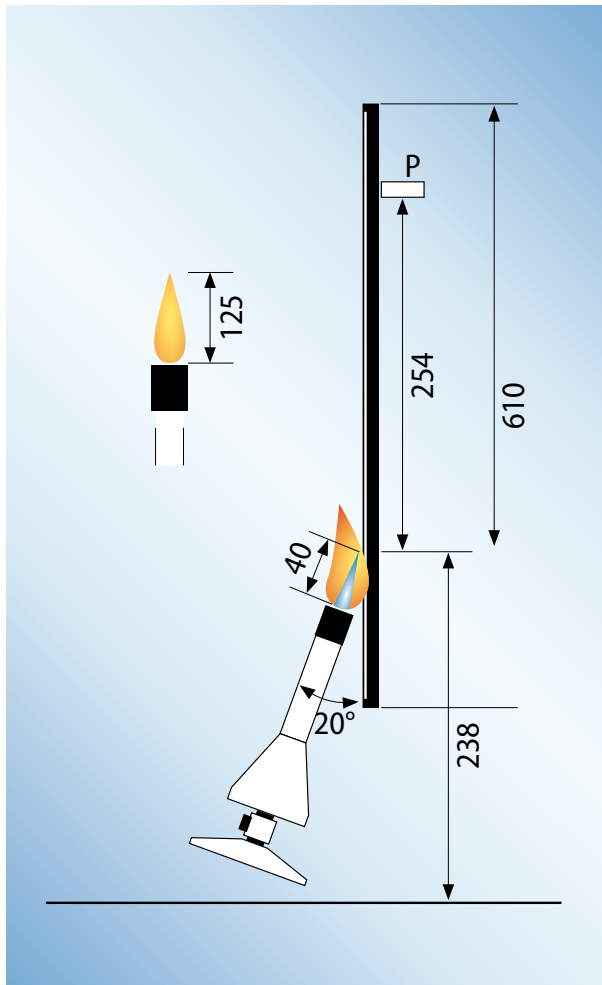

Test set-up:

The cable is fixed vertically and fitted with a paper indicator flag (P, 10 x 20 mm). A Tirrill burner (modified Bunsen burner), fixed at an angle of 20° to the vertical, is used to apply the flame.

Flame temperature: Determined by the specific setting of the Tirrill burner flame. The power amounts to 500 W.

Test duration:

Sec. 9.3: 5 cycles of flame applied for 15 s with a break of 15 s.

Sec. 9.4: 5 cycles of flame applied for 15 s with a break of 15 s and a maximum break of 60 s.

Sec. 1061: 3 cycles of flame applied for 60 s with a break of 30 s.

Compliance criteria:

The sample may continue to burn for a maximum of 60 s after the flame is removed and the paper indicator flag (P) can be carbonised at a maximum of 25 %. Any glowing or flaming material dripping off must not ignite the cotton wool (B) (does not apply to the FT1 test)

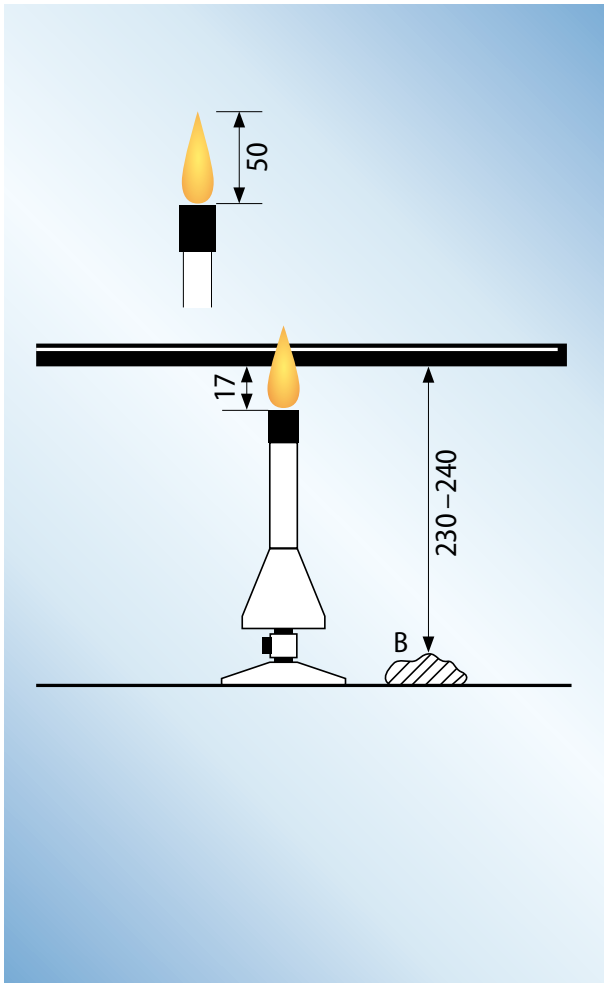
UL1581 Sec.1090 H / UL2556 Sec.9.1 FT2**Test set-up:**

The cable is fixed horizontally with a Tirrill burner flame applied vertically (for the FT2 test the burner is angled 20° from the vertical). The cotton wool (B) is laid out next to the burner.

Flame temperature:

Determined by the specific setting of the Tirrill burner flame.

Test duration:

30 sec

Compliance criteria:

Any glowing or flaming material dripping off must not ignite the cotton wool (B).

Sec. 1090: The flame propagation speed must not exceed 25 mm/min.

Sec. 9.1: The length of the carbonised part may not exceed 100 mm.

UL large scale flame tests

UL 1685 FT4 Test / IEEE 1202 – CSA method

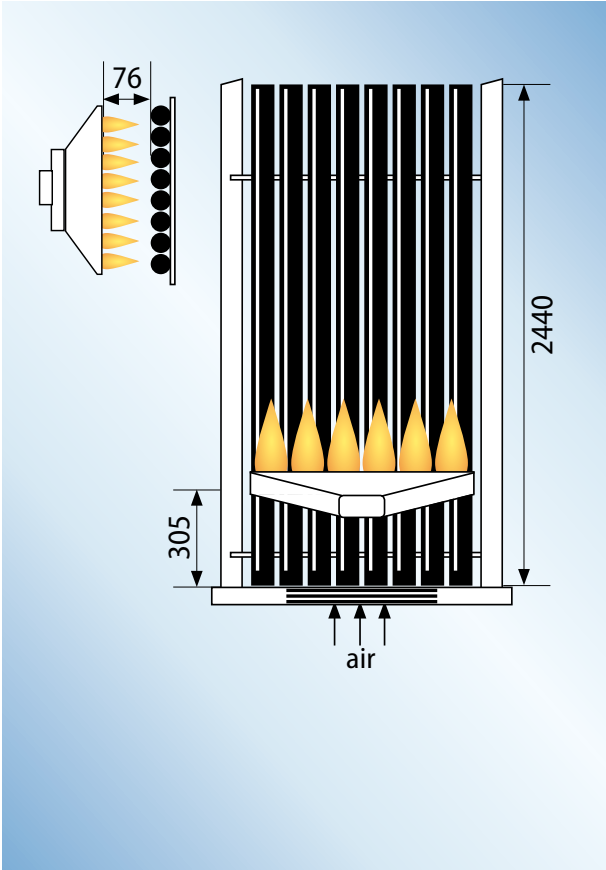

Test set-up:

The cables are fixed in several layers to a ladder (quantity depends on the cable diameter). The length of each specimen is 2.44 m (8 ft). Cables with a diameter < 13 mm may be fixed to the ladder in bunches. The burner is angled 20° from the horizontal.

Flame temperature:

Determined by the specific volumes of propane and air. The power amounts to 20.5 kW (70,000 Btu/hr).

Test duration:

20 minutes (2 test runs)

Compliance criteria:

The cable damage height shall be less than 1.50 m (4 ft 11 in) when measured from the lower edge of the burner surface.

UL 1685 Vertical Tray Test – UL method

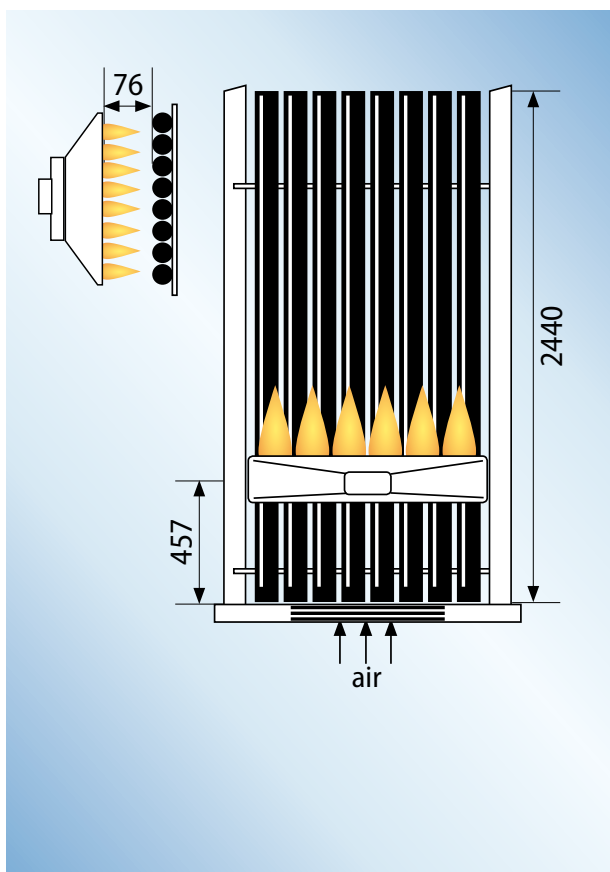

Test set-up:

One layer of cables is fixed to a ladder (quantity depends on the cable diameter). The length of each specimen is 2.44 m (8 ft).

Flame temperature:

Determined by the specific volumes of propane and air. The power amounts to 20.5 kW (70,000 Btu/hr).

Test duration:

20 minutes (2 test runs)

Compliance criteria:

The cable damage height shall be less than 2.44 m (8 ft) when measured from the bottom of the cable tray.

IEC single and large scale flame tests

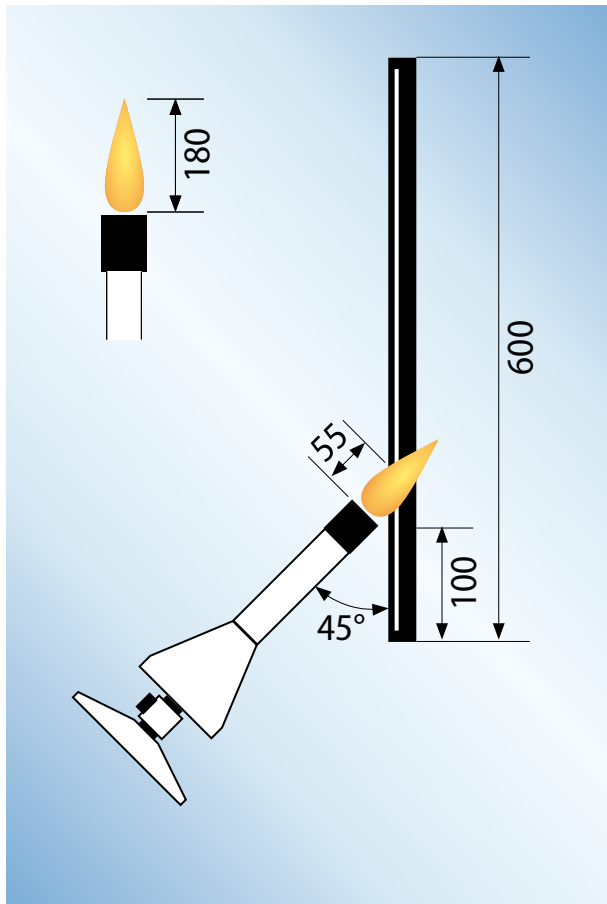

IEC 60332-1-2 / EN 60332-1-2 / VG 95218-2 Method 1 / BS 4066 Part 1

Test set-up:

The single cable to be tested is fixed vertically and exposed to a Bunsen burner flame at a 45° angle to the vertical. Test apparatus according to IEC/EN 60332-1-1

Flame temperature:

Determined by the specified setting of the Bunsen burner flame.

Test duration:

Cable with a diameter of ≤ 25 mm: 60 sec

Cable with a diameter of $25 < D \leq 50$ mm: 120 sec

Compliance criteria:

The fire damage must end at least 50 mm below the upper fixing clamp. The cable must be self-extinguishing.

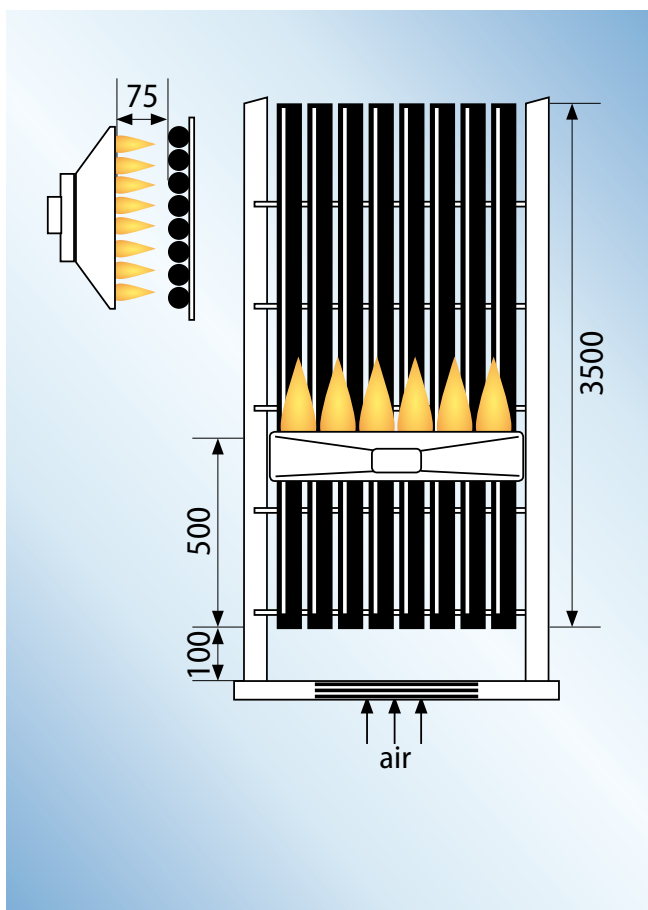

IEC 60332-3/EN 50266-2

Test set-up:

The cables are fixed to a ladder, close together or at a distance depending on the type of fire. The cables may be fixed in several layers.

Flame temperature:

Determined by the specified volume of propane and air.

Test duration:

Part 21: Category A F/R only for special applications

Part 22: Category A (7 l flammable material/m): 40 min

Part 23: Category B (3.5 l flammable material/m): 40 min

Part 24: Category C (1.5 l flammable material/m): 20 min

Part 25: Category D (0.5 l flammable material/m): 20 min

Compliance criteria:

Fire damage to the cable may be visible for a maximum of 2.5 m from the bottom of the burner to the top.

Quality and environment



LEONI quality management

LEONI's process oriented quality management is certified globally to ISO 9001 standard. With standardised process diagrams and process descriptions in our management handbook as well as process instructions, we ensure that precautionary quality assurance methods are used in all phases of production and that process as well as product quality is systematically improved. With forward quality planning during product and process development, testing tool capability combined with SPC, we monitor and optimise the entire value chain from goods receiving to production and through to delivery of our products to the customer. In our quality philosophy, documented in LEONI's quality policy and the quality targets based on the policy, customer satisfaction, delivery reliability and error avoidance have thus always had top priority.



LEONI environmental management

LEONI considers thinking and acting in an environmentally aware manner to be among the factors that point the way to successful growth in the future.

Our environmental system certified to the DIN EN ISO 14001:2004 standard provides all LEONI facilities with the means to systematically save natural resources. Consistent implementation of LEONI's environmental policy and the environmental targets based on it means that, at all facilities, there is continual reduction in energy and water consumption, emissions and waste as well as that our staff and suppliers are sensitised to environmental protection concerns.

Furthermore, as early as the product and process design stage, we take into account environmentally friendly technologies to develop and manufacture products that are ecologically compatible on a lasting basis. That our product range also includes lead-free and halogen-free insulation and jacket compounds goes without saying.

Automation & Drives expertise worldwide



Automation & Drives – Competence centers and manufacturing sites

Germany

LEONI Special Cables GmbH
(Friesoythe)

LEONI Special Cables GmbH
(Bruchsal)

LEONI Kabel GmbH

Spain

LEONI Systems Spain S.L.

Slovakia

LEONI Slovakia spol. s.r.o.

China

LEONI Cable (China) Co., Ltd.

Japan

LEONI Wire & Cable Solutions
Japan K.K.

Singapore

LEONI (SEA) Pte. Ltd

South Korea

LEONI Wiring Systems Korea, Inc.

USA

LEONI Engineering
Products & Services Inc.

Your contact

Buisness Unit Automation and Drives

LEONI Special Cables GmbH

Eschstrasse 1

26169 Friesoythe, Germany

+49 4491 291-5010

factory-automation@leoni.com



Factory Automation

www.leoni-factory-automation.com

factory-automation@leoni.com

 [@LeoniFactoryAut](https://twitter.com/LeoniFactoryAut)