

Verbindungen mit **System**
The **Power** of Partnership

Klauke[®]
A Textron Company



EBS 8ML



Serialnummer

Klauke[®] *mini*
made in Germany

HE.16105_A © 03/2015 R&D-2



Gustav Klauke GmbH • Auf dem Knapp 46 • D-42855 Remscheid
Telefon ++49 +2191-907-0 • Telefax ++49 +2191-907-141 • www.klauke.com



EBS 8ML

Klauke[®]
A Textron Company



2 years
Warranty
World wide
Tool
Service
Klauke ASC



Energy
Save ✓

St/Cu/Al | Ø 8 mm max.
 $\sigma = 1260 \text{ N/mm}^2 \text{ max.}$



Klauke ASC
Authorized Service Center

page 7

20 sec/5Hz

15 min.

RESTART



EN 50110

WORK



SERVICE



DON'T DO



General safety rules





EBS 8ML

Klauke®
A Textron Company

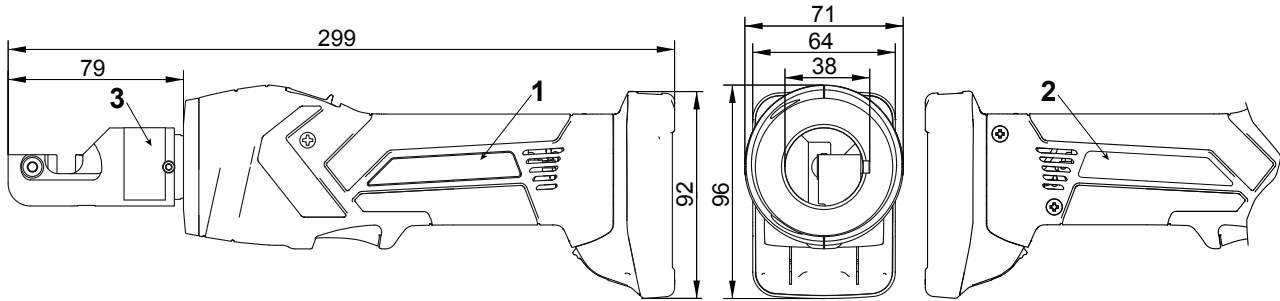

1

Klauke® mini
made in Germany



2

EBS8ML
Bolt cutter

Ø 8 mm
10,8 V DC

3

Achtung: Schneid Gefahr!
Caution: Sharp blades!

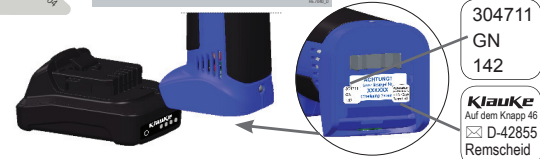

2 years or 10.000 cycles

Klauke ASC
Authorised Service Center

OLD
PART REPLACEMENT
SAFETY
NEW

ACHTUNG!
Garantie Siegel Nr. XXX/XXX
Bei Beschädigung / Garantieverlust

2 years
Warranty
World wide
Tool Service
Klauke ASC

batch# e.g. 304711
datecode e.g. G = 2013; N = Jan.
consecutive# e.g. „142“ = tool # 142
datecode

Year	Code	Month	Code	Month	Code
2013	G	Jan.	N	July	V
2014	H	Feb.	P	Aug.	W
2015	J	Mar.	Q	Sept.	X
2016	K	Apr.	R	Oct.	Y
2017	L	May	S	Nov.	Z
2018	M	June	T	Dec.	1





EBS 8ML

Klauke®
A Traxton Company

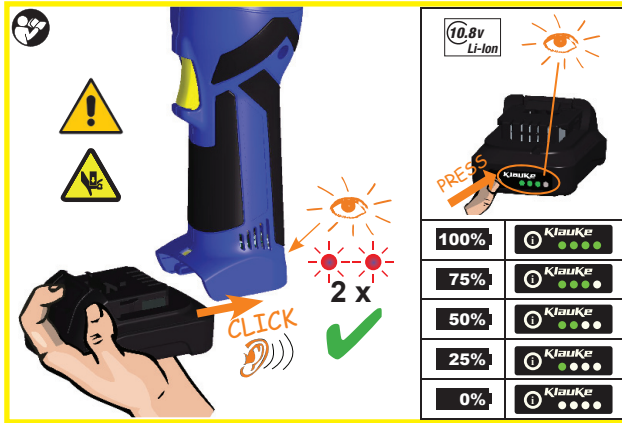



EBS 8ML

Klauke®
A Textron Company

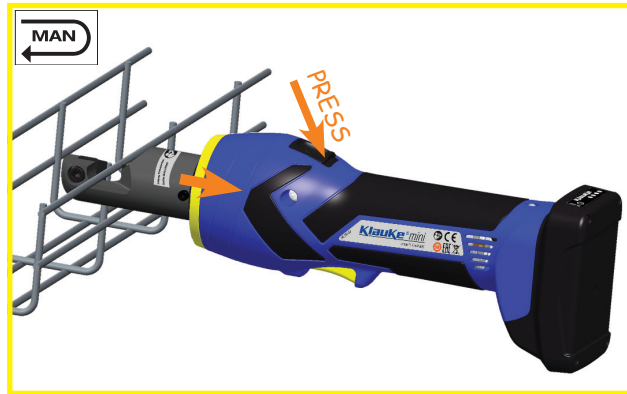
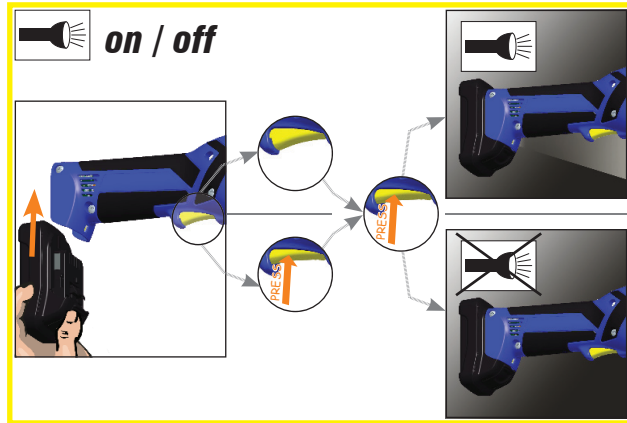
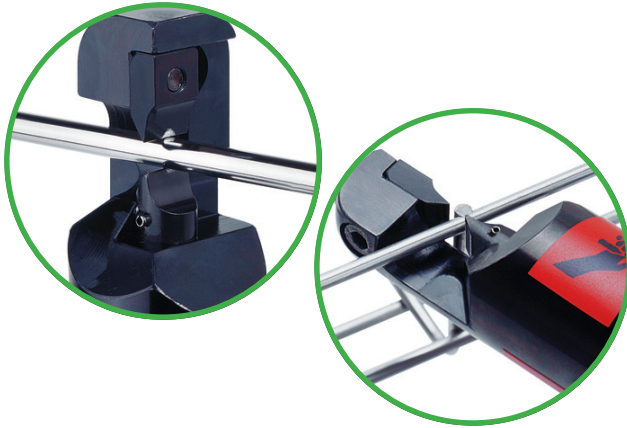



EBS 8ML

Klauke®
A Textron Company

Klauke® LGML1
Li-Ion Charger

Input: 230V 50-60 Hz 35W
Output: 10.8 V== 21.6W
Charge current: 2.0 A



Charging: 0°- 40°C

Made in Czech Republic

HE.15563_E

LGML1
350 g



Klauke® RAML1
Li-Ion Battery

10.8V == 1.5 Ah 16.2 Wh
Li-Ion 3IXR18/65 Rechargeable
IEC 62133 UN 38.3



Made in China

HE.16023_B



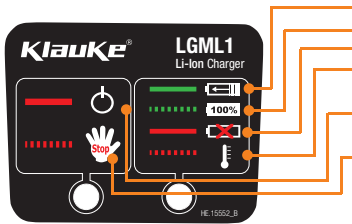









**LGML1****1.****2.**

D	GB	F	E
Ladeprozess beginnt	Charger is charging	Batterie en charge	Cargando
Akku ist vollgeladen	Battery is fully charged	Charge complete	Bateria cargada completamente
Akku ist defekt	Battery is defect	Batterie défectueuse	Bateria defectuosa
Akku ist zu heiß oder zu kalt	Battery is too hot or too cold	Batterie trop chaude ou trop froide	La batería está demasiado caliente o fría
Ladegerät ist am Stromnetz angeschlossen und ladebereit	Charger is connected with the mains socket and ready to charge.	Chargeur branché à la prise de courant prêt à être chargé.	El cargador está conectado a la red y listo para cargar
Ladegerät ist defekt	Charger is defect	Chargeur défectueux	Cargador defectuoso
Achtung (1. + 2.) Bitte beachten Sie, dass der Akku aus dem Ladeschacht entnommen werden muß, wenn das Ladegerät nicht am Netz angeschlossen ist. Ansonsten wird der Akku tiefentladen!	Attention (1. + 2.) Please remove the Battery out of the charging slot if the charger is not plugged into the socket. Failing to do so might results in destroying the battery by deep discharge!	Attention (1. + 2.) Sortir la batterie du chargeur si the chargeur n'est pas branché à la prise de courant. Ceci pourrait endommager la batterie avec chute de la charge!	Atención (1. + 2.) Por favor tenga en cuenta de quitar la batería de la base de carga cuando el cargador no esté conectado a la red. De lo contrario la batería sufrirá una descarga intensa.

P	NL	RUS	PL
O carregador está em carga	laadproces begint	Идет процесс зарядки	Ładowanie zaczęte
A bateria está completamente carregada	Accu is vol geladen	Аккумулятор полностью заряжен	Akumulator naładowany w pełni
A bateria está com defeito	Accu is defect	Аккумулятор поврежден	Akumulator jest uszkodzony
A bateria está demasiado quente ou fria	Accu is te heet of te koud	Аккумулятор очень горячий или холодный	Akumulator jest za gorący lub za zimny
O carregador está ligado à corrente e pronto a carregar	lader is aangesloten aan het stromnet en klaar om te laden	Зарядное устройство подключено к сети и готово к зарядке	Ładowarka jest podłączona do sieci i gotowa do pracy
O carregador está com defeito	lader is defect	Зарядное устройство повреждено	Ładowarka jest uszkodzona
Atenção (1. + 2.) Tenha em atenção que a bateria deve ser retirada do carregador quando não estiver ligado à corrente. Se não o fizer pode resultar na destruição da bateria por descarga intensa!	Opgelet (1.+2.) Aub de accu uit de ladesleuf verwijderen als de lader niet aan het stromnet is aangesloten. Als niet kann het tot een diepontlading van de accu komen	Внимание (1 + 2) Обратите внимание, что аккумулятор нужно извлекать из зарядного устройства только если зарядное устройство отключено от сети. В противном случае может произойти полная разрядка аккумулятора.	Uwaga (1 + 2) Proszę pamiętać, że akumulator musi być usunięty ze złącza ładowarki w chwili, gdy nie jest ona podłączona do sieci. Inaczej akumulator może ulec głębokiemu rozładowaniu.



	Wann/When/Quand/Quando/cuándo/Wanneer/Когда это происходит/Kiedy	Warum/Why/Pourquoi/Porquê/¿por qué?/Waarom/ Причина/Dlaczego
 20 sec	nach Arbeitsvorgang/after working cycle après opération de travail Después del proceso de trabajo após o processo de trabalho na bedrijfscyclus после цикла опрессовки po zakończeniu pracy	
 2 x	nach Einsetzen des Akkus/after inserting the battery après mise en place de l'accumulateur Después de insertar la batería após inserir a bateria na het plaatsen van de accu при установке аккумулятора przy włożeniu akumulatora	Selbsttest/Self check autocontrôle Auto-test Autoteste zelftest Проверка инструмента autotest
 20 sec/2Hz	nach Arbeitsvorgang/after working cycle après opération de travail Después del proceso de trabajo após o processo de trabalho na bedrijfscyclus после цикла опрессовки po zakończeniu pracy	 Klauke ASC® Authorised Service Center
 20 sec/5Hz	während der Übertemperatur/while exceeding the temp. limit pendant surchauffe en caso de temperatura excesiva durante a temperatura excessiva tijdens te hoge temperatuur при высокой температуре внутри корпуса w czasie nadmiernej temperatury	Werkzeug zu heiß/Unit too hot outil surchauffé Herramienta demasiado caliente ferramenta demasiado quente gereedschap te heet Перегрев инструмента narzędzie za gorące
 20 sec  20 sec/2Hz	nach Arbeitsvorgang/after working cycle après opération de travail Después del proceso de trabajo após o processo de trabalho na bedrijfscyclus после цикла опрессовки po zakończeniu pracy	 Klauke ASC® Authorised Service Center 



D GB F E				P NL RUS PL			
Gewicht (inkl. Akku): Weight (incl. battery): Poids (batterie incl.): Peso (incluida batería):	~ 1,34 kg	Akkukapazität: Battery capacity: Capacité batterie: Capacidad de la batería:	1,5 Ah, Li-Ion (RAML1)	Peso (incluido batería): Gewicht (incl. accu) Вес (с аккумулятором) Waga (z aku.)	~ 1,34 kg прим. 1.34 кг	Capacidade da bateria Accu saraciteit Емкость аккумулятора Pojemność akumulatora:	1,5 Ah, Li-Ion (RAML1)
Schneidkraft: Cutting force: Force de coupe: Fuerza de corte:	15 kN	Akku-Ladezeit: Charging time: Temps de charge: Tiempo de carga:	40 min. (RAML1)	força de corte Knipkracht Усилие резания: Siła tnąca:	15 kN	Tempo de carregamento da bateria Accu laadtijd Время зарядки Czas ładowania akumulatora:	40 min. (RAML1) прим. 40 мин (RAML1)
Umgebungstemp.: Environmental temp.: Temperature ambient: Temperatura de ambiente:	-10°C : +40°C	Akkuspannung: Battery voltage: Tension batterie: Voltaje de la batería:	10,8 V	Temperatura ambiente Omgevingstemperatur Температура окр. среды Temperatura otoczenia:	-10°C : +40°C	Tensão da bateria Accu spanning Напряжение аккумулятора Napięcie akumulatora:	10,8 V 10,8 V
Schutzklasse: Protection class: - F - : - E - :		IP 2X		- P - : - NL - : - RUS - : - PL - :		IP 2X	
Schneidzeit: Cutting time: Temps de sectionnement: Tiempo de Cortar:	1 s			Tempo de corte Perstijd Время опрессовки Czas zaprasowywania:		1 s	
Schnitte pro Akku: Cuts per battery: Autonomie/batterie: Número de cortes por pila:	~300 Schnitte (Ø 5 mm) ~300 cuts (Ø 5 mm) ~300 coupes (Ø 5 mm) ~300 de corte (Ø 5 mm)			Cortes por batería: Autonomie: Количество резаний на одну зарядку аккумуля-ра: Ilość cięć na akumulator:		cerca de 300 cortes (Ø 5 mm) ~300 snijdingen (Ø 5 mm) ок. 300 отрезаний (Ø 5 mm) ок. 300 cięć (Ø 5 mm)	
Schalldruckpegel: Sound level: Niveau acoustique: Nivel de presión sonora:	< 70 dB (A) in 1m Abstand < 70 dB (A) in 1m distance < 70 dB (A) à une distance de 1m < 70 dB (A) a una distancia de 1m			Nivel sonoro Klank niveau Уровень шума Napięcie hałasu:		< 70 dB (A) a uma distância de 1m < 70 dB (A) in 1m afstand < 70 dB (A) на расстоянии 1 м < 70dB (A) w odległości 1m	
Vibrationen: Vibrations: Vibrations: Vibraciones:	< 2,5 m/s ² (gewichteter Effektivwert der Beschleunigung) < 2,5 m/s ² (Valor eficaz ponderado de aceleración)		1) 2)	Vibrações Vibraties Вибрации Wibracje:		< 2,5 m/s ² (o valor eficaz ponderado de aceleração) < 2,5 m/s ² < 2,5 m/s ² < 2,5 m/s ² (pomiar rzeczywisty)	

1) Kann vom tatsächlichen Wert abweichen, abhängig von der Benutzung

2) DIN EN 60745-1

DEUTSCHLAND
 Klauke Remscheid
 Mr. Michael Radtke
 Auf dem Knapp 46
 42855 Remscheid (Germany)
 ☎ 0049-2191/907-222
 ☎ 0049-2191/907-243
 ✉ service@klauke.textron.com



FRANKREICH
 Klauke France
 Mr. Daniel Berrar
 16, Rue Saint-Louis
 Z.I. Actisud
 57150 Creutzwald (France)
 ☎ 0033-3-87298470
 ☎ 0033-3-87298479
 ✉ dberrar@klauke.textron.com



GROSSBRITANNIEN
 Klauke UK Ltd.
 Mr. Maurice Garrod
 Hillside Road East
 Bungay
 Suffolk, NR35 1JX (UK)
 ☎ 0044-1986-891513
 ☎ 0044-1986-896132
 ✉ mgarrod@klauke.textron.com



ISRAEL
 Shay A.U., Ltd.
 Mr. Shay
 Ind. Zone Kiriat Arie
 Embar Street 23/25
 P.O. BOX 10049
 49222 Petach Tikva (Israel)
 ☎ 00972-3-9233601
 ☎ 00972-3-9234601
 ✉ ilans@uriel-shay.com



ITALIEN
 CO.ME.T. OFFICINE SRL
 Divisione Utensili
 Mr. Roberto Aleotti
 Via Castellfranco n. 46
 40017 San Giovanni in Persiceto -
 Fratz. Tivoli (BO) (Italy)
 ☎ 0039-051-6878736
 ☎ 0039-051-799902
 ✉ tools@officinemet.com



NIEDERLANDE
 H.K. Electric B.V.
 Mr. Mike Vinger
 De Steegen 5-7
 5321 JZ Hedel (Netherlands)
 ☎ 0031-73-5997599
 ☎ 0031-73-5997590
 ✉ Service@hkelectric.nl



ÖSTERREICH
 Klauke Handelsgesellschaft mbH
 Mr. Alexander Riegler
 Ared-Str. 7 TOP3
 2544 Leobersdorf (Austria)
 ☎ 0043-2256-62925
 ☎ 0043-2256-62930
 ✉ atoffice@klauke.textron.com



POLEN
 Despol Techniki
 Montazowe Sp z o.o.
 Mr. Jaworski
 ul. Podgorska 3
 02-921 Warszawa (Poland)
 ☎ 0048-22-6428570
 ☎ 0048-22-6420500
 ✉ mjaworski@despoltm.pl



PORTUGAL
 Palissy Galvani
 Electricidade S.A.
 Ms. Ana Pereira
 Complexo Industr. da Granja, Pav. A8,
 Granja-2625-607 Vialonga (Portugal)
 ☎ 00351-21-3223400
 ☎ 00351-21-3223410
 ✉ ana.pereira@palissygalvani.pt



SLOWENIEN
 Isaria d. o.o.
 Ms. Zorž
 Proizvodnja in trgovina Cece 2a
 1420 Trbovlje (Slovenia)
 ☎ 00386-356-31800
 ☎ 00386-356-31802
 ✉ isaria.trbovlje@siol.net



SERBIEN
 Nidas d.o.o.
 Mr. Misailovic
 Majke Kujundzic 7
 11000 Beograd (Serbia)
 ☎ 00381-2417-714
 ☎ 00381-2417-715
 ✉ nidas@eunet.rs



SPANIEN/ANDORRA
 Textron Iberia S.L.
 Mr. Ciborro
 C/Severo Ochoa N. 4
 Nave 15
 28521 Rivas-Vaciamadrid
 Madrid (Spain)
 ☎ 0034-917518203
 ☎ 0034-917518195
 ✉ serviceiberia@klauke.textron.com



FINNLAND
 CableX oy
 Mr. Reijo Karlsson
 Karsmäentie 23
 20360 Turku (Finland)
 ☎ 00358-2-8800020
 ☎ 00358-2-8800021
 ✉ reijo.karlsson@cablex.fi



SÜDARFIKA
 Eberhard Martin CC
 Mr. Roger Martin
 55 Evelyn Street
 Newlands Johannesburg
 (South Africa)
 Post point Delarey 2114
 ☎ 0027-11-2880000
 ☎ 0027-11-6732043
 ✉ ebm@ebm.co.za



**TSCHECHISCHE REPUBLIK/
 SLOVAKEI**
 Klauke Slovakia s.r.o.
 Mr. Martin Legunis
 Nabrezie Oravy 2711
 02601 Dolný Kubín (Slovakia)
 ☎ 00421-43-58323-11
 ☎ 00421-43-58323-34
 ✉ ASC-SK@klauke.textron.com



SCHWEIZ
 Ferratec AG
 Mr. Bürgisser
 Großmattstr. 19
 CH-8964 Rudolfstetten (Switzerland)
 ☎ 0041-56-6492121
 ☎ 0041-56-6492141
 ✉ info@ferratec.ch



AUSTRALIEN
 (regional)
 The Energy Network PTY LT
 Mr. Paul Greenough
 65 Werthout Place
 Banyo, QLD 4014 (Australia)
 ☎ 0061-732128999
 ☎ 0061-732128998
 ✉ paul.g@tengroup.com.au



(regional)
 The Energy Network PTY LT
 Mr. Ivan.Haene
 4/15 Baile Road
 Canning Vale, WA 6155 (Australia)
 ☎ 0061-400029026
 ☎ 0061-892564075
 ✉ ivan.haene@tengroup.com.au

(regional)
 Parks Hydraulic Service
 Mr. Greg Maher
 11 - 13 Duke street
 Abbotsford, Vic 3067 (Australia)
 ☎ 0061-3-94292072
 ☎ 0061-3-94297199
 ✉ parkshy@bigpond.net.au

NEUSEELAND
 Jonel Hydraulics Ltd.
 Mr. George Pavletich
 7 Blackburn Road
 East Tamaki Auckland (New Zealand)
 ☎ 0064-9-2749294
 ☎ 0064-9-27308231
 ✉ enerpac@jonel.co.nz



SOUTH KOREA
 KESCO Co. Ltd
 Mr. TSOH
 2-1608, ACE HiTech City, 54-66
 Mullaee-Dong, Youngdeungpo-Gu
 Seoul 150-093 (South Korea)
 ☎ 0082-2-261409-89
 ☎ 0082-2-261409-66
 ✉ tsoh@kesco.com



VOLKSREP. CHINA
 (regional)
 Hangzhou Beta Equipment
 Manufacture Co., Ltd
 Mr. Fu Li Bin
 No. 308 Shiqiao Rd.
 Hangzhou, 31009 (China)
 ☎ 0086-571-88151096
 ☎ 0086-571-88151096
 ✉ bt-bf@hotmail.com



(regional)
 Shanghai Huasai Trading Co. Ltd
 Mr. Bao Jun
 255 Xinjingqiao Road # 729,
 Pudong New Area,
 Shanghai, 200233 (China)
 ☎ 0086-21-688636015265 8823
 ☎ 0086-21 50189233-8004
 ✉ sherry.shi@tropss.com

(regional)
 Guangzhou Xueqin Electrical
 Appliance Trading Co. Ltd
 Mr. Luo Yu Tang
 RM B08 Floor 7th,
 Huifeng Building, No.75 Xianlie Rd.
 Guangzhou, 510095 (China)
 ☎ 0086-20-87323432
 ☎ 0086-20-87327792
 ✉ xueqin08@126.com

(regional)
 Beijing Black Hawk Hydraulic
 Equipment Service Co. Ltd.
 Mr. Song Jun Lin
 No. 10 building xiaoguandangongli
 chanyang Beijing, 100028 (China)
 ☎ 0086-10-64912283
 ☎ 0086-10-64924369
 ✉ hyservice8@gmail.com

(regional)
 Chengdu TaiDi Trading Co. Ltd
 Mr. Zhang Hao
 Rm 618
 No. 15' South Yulin Road Chengdu
 City
 Chengdu Schuan, 100028 (China)
 ☎ 0086-28-85592749
 ☎ 0086-28-85595948
 ✉ taili@mail.sc.cninfo.net

SCHWEDEN
 AGB Service AB
 Mr. Anders Bennarsten
 Flottilvägen 22
 SE-39241Kalmår (Sweden)
 ☎ 0046-480-28174
 ☎ 0046-480-28165
 ✉ anders@agbservice.se



AGB Service AB
 Mr. Anders Bennarsten
 Rosstigen 2
 SE-169 53 Solna (Sweden)
 ☎ 0046-8202245
 ☎ 0046-707550145
 ✉ anders@agbservice.se

NORWEGEN
 Proxll
 Mr. Odd Einar S. Greipslund
 Malerhaugvn. 25
 P.O. Box 6730 Etterstad
 N-0609 Oslo (Norway)
 ☎ 0047-22088100
 ☎ 0047-22088101
 ✉ odd.einar.svendson@proxll.no



UNGARN
 Trend Elektro
 Mr. Istvan Imrik
 2049 Diósd HUNGARY
 Petofi Sándor utca 27 - 29 (Hungary)
 ☎ 0036-23545-140
 ☎ 0036-23545-141
 ✉ info@trendelektro.hu



TÜRKEI
 Kardes Elektrik Sanayi ve Ticaret A.S.
 Mr. Emircan Aktas
 Eski Londra Asfalti No. 6
 34630 Besyol-Sefaköy-
 Istanbul (Turkey)
 ☎ 0090-212-6429204
 ☎ 0090-212-5924810
 ✉ eaktas@kardeselektrik.com.tr



RUSSLAND
 Unit Mark Pro
 Mr. Alexander Tarasov
 109147 Moscow
 Marksistskaya 34, bldg 10 (Russia)
 ☎ 007-495-7480747
 ☎ 007-495-7483735
 ✉ tarasov@umpgroup.ru



ROMÂNIA
 Gerkon Electro S.R.L.
 Mr. Heim
 str. Márton Áron Nr. 45
 530211 Miercurea Ciuc
 (Romania)
 ☎ 0040-266-372108
 ☎ 0040-266-312238
 ✉ office@gerkonelectro.ro



INDIEN
 Bishop Electricals
 Mr. Abbashek Rajshashekar
 64, Avighna, 8th Main,
 Defence Colony, Vinayaka Nagar
 Bagalur Cross, yelahanks,
 Bangalore 560064 (India)
 ☎ 0091-9886115506
 ☎ 0091-8026914568
 ✉ servicecentre@
 bishopselectricals.com



GRIECHENLAND
 Kalamarakis Saponas SA
 Mr. Georg Kostakos
 Ionias & Neromilou str.
 GR-13671 Chamilomios – Acharnes
 Athen (Greece)
 ☎ 0030-210-240-6000
 ☎ 0030-210-240-6007
 ✉ gkostakos@ksa.gr



USA
 Goodman Textron
 Technical Support
 Mr. Tim Kopp
 4411 Boing Drive
 Rockford, IL 61109-2932 (USA)
 ☎ 001-800-435-0786
 ☎ 001-800-451-2632
 ✉ tkopp@greenlec.textron.com



JAPAN
 Goodman Inc
 Mr. Kazu Watanabe
 2-3-3 Mitsuura-higashi, Kanazawaku,
 Yokohama, Kanagawa 236-0037
 (Japan)
 ☎ 0081-45-701-5680
 ☎ 0081-45-701-4302
 ✉ kazu@goodman-inc.co.jp



VENEZUELA
 RB-TOOLS, C.A.
 Mr. Rafael Benitez
 Av. La Estancia, CCCT, Nivel PB,
 MBE local 4, Suite 207,
 Urb. Chuao 1064
 Caracas - Venezuela
 ☎ 0058-212-264441
 ☎ 0058-212-264422
 ✉ rbttools@cantv.net



BOSNIEN + HERZEGOWINA
 Kabeltech D. O.O.
 Mr. Habibovic
 Ferde Hauptmann 7/1
 71000 J'Sarajevo
 (Bosnia-Herzegovina)
 ☎ 00387-33-713060
 ☎ 00387-33-713063
 ✉ info@kabeltech.co.ba



Klauke India
 a division of Textron India Pvt. Ltd.
 Mr. Kiran Marjunath
 Adithi Enclave, 2nd Floor,
 #29, 80 Feet Road
 4th Block, Kormangala
 Bangalore 560064 (India)
 ☎ 0091-9738464980
 ☎ 0091-9902322466
 ✉ kmanjunath@textron.com



THAILAND
 Summit Engineering+Service Co.,LTD.
 Mrs. Sudsuda Panpiemras
 236/418-421 Sniwara Mansion 1
 Ratchadapiseake Rd.
 BKK 10400 (Thailand)
 ☎ 00662-6422478-9
 ☎ 00662-6423085
 ✉ sudsuda@ses-th.com



INDONESIA
 PT. Aura Sinarindo Abadi
 Mr. Rifkiyadi
 Jl. Gading Kirana Timur Blok A11/8
 Kelapa Gading, Jakarta 14240
 (Indonesia)
 ☎ 0062-214534237
 ☎ 0062-214534238
 ✉ rifkiyadi@aurasinarindo.com

PT. Great Dynamic Indonesia
 Mr. Ali Suwondo
 Komplek Sriyaja Abadi Blok F no.
 7 – 10
 Riau Island (Indonesia)
 ☎ 0062-778-455514
 ☎ 0062-778-430275
 ✉ gdi@greatdynamic.com



ISLAND
 Reykjafell hf.
 Pressure Hydraulic Ltd
 Mr. Otto Gudjonsson
 Skipholt 35
 105 Reykjavik (Iceland)
 ☎ 00354-5886000
 ☎ 00354-5886012
 ✉ otto@reykjafell.is



DÄNEMARK
 Scherer's Elektro ApS
 Mr. Steffen Kristensen
 Valhøjs Allé 171 st.
 2610 Rødovre (Denmark)
 ☎ 0045-4484-3738
 ☎ 0045-4484-3708
 ✉ steffen@scherrers-elektro.dk



MEXIKO
 Technoherramientas
 Hidraulicas
 Mr. Alvaro Bolanos N.
 Alumnos No. 57,
 Col. San Miguel Chapultepec
 C.P. 11850, Mexico, D.F.
 ☎ 0052-55-52179165
 ☎ 0052-55-52120413
 ✉ alvarob@
 tecnohidraulicas.com.mx



KROATIEN
 Konekt d.o.o.
 Mr. Dubravko Salkovic
 Cerinina 4
 HR-10000 Zagreb (Croatia)
 ☎ 00385-12361890
 ☎ 00385-12361882
 ✉ konekt@konekt.hr



VIETNAM
 Phongviet Co., Ltd
 Mr. Tran Dinh Thua
 No 7-9, 65 street
 Tan Phong Ward District 7
 Ho Chi Minh City (Vietnam)
 ☎ 0084-8-37717179
 ☎ 0084-8-37715791
 ✉ thuan@phongvietco.vn



LIBANON
 Al-Boniani Group
 Mr. Sleiman
 Tayouneh, Al-Ghazaleh Build.,
 P.O.Box 13
 6470 Beirut-Lebanon (Lebanon)
 ☎ 00961-1-385 708
 ☎ 00961-1-385 714
 ✉ houssam.sleiman@
 al-boniangroup.com



TAIWAN
 Po Chang Co.Ltd
 Mr. Vincent Chen
 No. 166, Sung Sin Road
 Sun Yi Dist, Taipei 110 (Taiwan)
 ☎ 0084-886227631623
 ☎ 0084-886227667492
 ✉ vincent.cn@msa.hinet.net



IRLAND
 Pressure Hydraulic Ltd
 Mr. Noel Fallon
 408C Unit Greenogue Ind. Est.
 Rathcoole, Co. Dublin (Ireland)
 ☎ 00353-1-4588880
 ☎ 00353-1-4588940
 ✉ nfallon@pressure-hydraulics.com



BELGIEN
 NBR Nussbaumer & Cie
 Mr. Kevin Herremans
 Zinkstraat 10
 B-1500 Halle (Belgium)
 ☎ 0032-23570940
 ☎ 0032-23549679
 ✉ atelieur@nussbaumer.be



MALAYSIA
 Jasama
 Engineering (M) SDN BHD
 Mr. Sazzalizam Miskan
 42, Blok D Plaza Jelutong
 No 5C, Persiaran Gerbang Utama
 Bukit Jelutong, Seksyen U8
 40150 Shan Alam Selangor
 Selangor Darul Ehsan (Malaysia)
 ☎ 00603-78322220
 ☎ 00603-77341457
 ✉ jasama2013@unifi.my

SINGAPUR
 Sun Hydraulics Pte Ltd
 Mr. Kirk Yap
 4001 Ang Mo Kio Industrial Park
 1, #01-1
 Singapore 569622 (Singapore)
 ☎ 0065-96929681
 ✉ sales@sunhydraulics.com.sg



UKRAINE
 Techlight LTD
 Mr. Yury Tsiyuyk
 17, Seragina str. Of. 105
 36008 Poltava (Ukraine)
 ☎ 0038-0532-500970
 ☎ 0038-050-5242646
 ✉ Y.Tsiyuyk@techlight.com.ua

KANADA
 Western Utility
 Equipment Ltd.
 Mr. Danny Gunderson
 3347 58 Avenue SE
 Calgary, AB Canada T2C 0B4
 (Canada)
 ☎ 001-403-291-1121
 ☎ 001-403-250-1136
 ✉ danny@westernlineman.com



LITAUEN
 Technikos Meistriai
 Ms. Gitana Kreismoniene
 Vilkipėdės g. 8, 5 korpusas
 Vilnius LT- 03151 (Lithuania)
 ☎ 00370-5-2311564
 ☎ 00370-5-2311564
 ✉ info@technikos.com



Handgeführtes batteriebetriebenes Schneidwerkzeug Typ EBS 8ML

Handoperated battery driven cutting tool type EBS 8ML

Klauke®
A Textron Company

(D) CE - '15 - Konformitätserklärung. Wir erklären in alleiniger Verantwortlichkeit, daß dieses Produkt mit den folgenden Normen oder normativen Dokumenten übereinstimmt:
EN 60745-1, EN ISO 12100, EN ISO 13857, EN 349, EN 60204-1, EN 28662-1, EN 61000-6-3, EN 61000-6-2, EN 60529, EN 1037 gemäß den Bestimmungen der Richtlinien 2006/42/EG, 2014/30/EU, 2011/65/EU

(GB) CE - '15 - Declaration of conformity. We declare under our sole responsibility that this product is in conformity with the following standards or normative documents:
EN 60745-1, EN ISO 12100, EN ISO 13857, EN 349, EN 60204-1, EN 28662-1, EN 61000-6-3, EN 61000-6-2, EN 60529, EN 1037 in accordance with the regulations of directives 2006/42/EG, 2014/30/EU, 2011/65/EU

(F) CE - '15 - Déclaration de conformité. Nous déclarons sous notre seule responsabilité que ce produit est en conformité avec les normes ou documents normatifs suivants:
EN 60745-1, EN ISO 12100, EN ISO 13857, EN 349, EN 60204-1, EN 28662-1, EN 61000-6-3, EN 61000-6-2, EN 60529, EN 1037 conformément aux réglementations des directives 2006/42/EG, 2014/30/EU, 2011/65/EU

(NL) CE - '15 - Konformiteitsverklaring. Wij verklaren en wij stellen ons er alleen voor verantwoordelijk dat dit produkt voldoet aan de volgende normen of normatieve documenten:
EN 60745-1, EN ISO 12100, EN ISO 13857, EN 349, EN 60204-1, EN 28662-1, EN 61000-6-3, EN 61000-6-2, EN 60529, EN 1037 overeenkomstig de bepalingen van de richtlijnen 2006/42/EG, 2014/30/EU, 2011/65/EU

(P) CE - '15 - Declaração de conformidade. Declaramos sob nossa exclusiva responsabilidade que este producto cumple as seguintes normas ou documentos normativos:
EN 60745-1, EN ISO 12100, EN ISO 13857, EN 349, EN 60204-1, EN 28662-1, EN 61000-6-3, EN 61000-6-2, EN 60529, EN 1037 conforme as disposições das directivas 2006/42/EG, 2014/30/EU, 2011/65/EU

(N) CE - '15 - Konformitetserklæring. Vi erklærer på eget ansvarlighed at dette produkt er i overensstemmelse med følgende standarder eller standard-dokumenter:
EN 60745-1, EN ISO 12100, EN ISO 13857, EN 349, EN 60204-1, EN 28662-1, EN 61000-6-3, EN 61000-6-2, EN 60529, EN 1037 i henhold til bestemmelserne i direktive ne 2006/42/EØF, 2014/30/EU, 2011/65/EU

(E) CE - '15 - Declaración de conformidad. Declaramos bajo nuestra sola responsabilidad que este producto está en conformidad con las normas o documentos normativos siguientes:
EN 60745-1, EN ISO 12100, EN ISO 13857, EN 349, EN 60204-1, EN 28662-1, EN 61000-6-3, EN 61000-6-2, EN 60529, EN 1037 de acuerdo con las regulaciones de las directivas 2006/42/EG, 2014/30/EU, 2011/65/EU

(I) CE - '15 - Dichiarazione di conformità. Dichiariamo sotto la nostra esclusiva responsabilità che questo prodotto è conforme alle seguenti norme e documenti normativi:
EN 60745-1, EN ISO 12100, EN ISO 13857, EN 349, EN 60204-1, EN 28662-1, EN 61000-6-3, EN 61000-6-2, EN 60529, EN 1037 conformemente alle disposizioni delle direttive 2006/42/EG, 2014/30/EU, 2011/65/EU

(DK) CE - '15 - Konformitetserklæring. Vi erklærer under almindeligt ansvar at dette produkt er i overensstemmelse med følgende normer eller normative dokumenter:
EN 60745-1, EN ISO 12100, EN ISO 13857, EN 349, EN 60204-1, EN 28662-1, EN 61000-6-3, EN 61000-6-2, EN 60529, EN 1037 i henhold til bestemmelserne i direktiverne 2006/42/EØF, 2014/30/EU, 2011/65/EU

(FIN) CE - '15 - Todistus standardinmukaisuudesta. Asiasta vastaavana todistamme läten, että tämä tuote on seuraavien standardien ja standardoimisasiakirjojen vaatimusten mukainen:
EN 60745-1, EN ISO 12100, EN ISO 13857, EN 349, EN 60204-1, EN 28662-1, EN 61000-6-3, EN 61000-6-2, EN 60529, EN 1037 ja vastaa säädöksiä 2006/42/EG, 2014/30/EU, 2011/65/EU

(PL) CE - '15 - Zgodność z dyrektywami CE. Świadomi odpowiedzialności oświadczamy, że niniejszy produkt jest zgodny z następującymi normami lub dokumentacja normatywna:
EN 60745-1, EN ISO 12100, EN ISO 13857, EN 349, EN 60204-1, EN 28662-1, EN 61000-6-3, EN 61000-6-2, EN 60529, EN 1037 zgodnie z postanowieniami wyciecznych 2006/42/EG, 2014/30/EU, 2011/65/EU

(GR) CE - '15 - ΔΗΛΩΣΗ ΣΥΜΜΟΡΦΩΣΗΣ Με ααληγήνη συνολικηη δηλωρημε οη το πορον προιον συμφωνει με τα παρακατω ποτυπα και με τα ηροτυπα ηου αναφερονται στα σχεπηκο εγγραφα EN 60745-1, EN ISO 12100, EN ISO 13857, EN 349, EN 60204-1, EN 28662-1, EN 61000-6-3, EN 61000-6-2, EN 60529, EN 1037 συμφωνα με τοχσ κοινοσημου 2006/42/EG, 2014/30/EU, 2011/65/EU

(H) CE - '15 – Megfelelőségi nyilatkozat. Kéziműködtetésű elektromos kéziszerszámok: Tejes felelősségel kijelentjük, hogy ezek a termékek a következő szabványokkal és irányelvekkel összhangban vannak: EN 60745-1, EN ISO 12100, EN ISO 13857, EN 349, EN 60204-1, EN 28662-1, EN 61000-6-3, EN 61000-6-2, EN 60529, EN 1037; és megfelelnek a rendeltetés szerinti 2006/42/EG, 2014/30/EU, 2011/65/EU irányelveknek.

(SK) CE – Prehľadanie o zhode. Prehlasujeme na vlastnú zodpovednosť, že tieto produkty sú v súlade s nasledovnými normami: EN 60745-1, EN ISO 12100, EN ISO 13857, EN 349, EN 60204-1, EN 28662-1, EN 61000-6-3, EN 61000-6-2, EN 60529, EN 1037 a v zhode so smernicami 2006/42/EG, 2014/30/EU, 2011/65/EU

(CZ) CE - '15 – Prohlášení o shode. Prohlašujeme na vlastní zodpovědnost, že tyto produkty splňují následující normy nebo normativní listiny:
EN 60745-1, EN ISO 12100, EN ISO 13857, EN 349, EN 60204-1, EN 28662-1, EN 61000-6-3, EN 61000-6-2, EN 60529, EN 1037; Ve shode se smernicami 2006/42/EG, 2014/30/EU, 2011/65/EU

(S) CE - '15 - Konformitetsdeklaration. Vi förklarar på eget ansvar att denna produkt överensstämmer med följande normer eller normativa dokument:
EN 60745-1, EN ISO 12100, EN ISO 13857, EN 349, EN 60204-1, EN 28662-1, EN 61000-6-3, EN 61000-6-2, EN 60529, EN 1037 enligt bestämmelserna i direktiverna 2006/42/EG, 2014/30/EU, 2011/65/EU

(RO) CE - '15 - Declarație de conformitate. Noi declarăm pe propria răspundere că acest produs este în conformitate cu următoarele norme și documente normative:
EN 60745-1, EN ISO 12100, EN ISO 13857, EN 349, EN 60204-1, EN 28662-1, EN 61000-6-3, EN 61000-6-2, EN 60529, EN 1037; potrivit dispozițiilor directivelor 2006/42/EG, 2014/30/EU, 2011/65/EU

Remscheid, den 05.03.2015

CE

Joh. - Christoph Schütz

Dipl.-Ing. Joh.-Christoph Schütz, CE-Beauftragter