



www.klauke.com

EK 120IDCFM



Serialnumber

HE.17262_C © 05/2016 R&D-2



Gustav Klauke GmbH • Auf dem Knapp 46 • D-42855 Remscheid • Telefon ++49 +2191-907-0 • Telefax ++49 +2191-907-141 • www.klauke.com

Klauke®



Wir freuen uns, dass Sie sich für ein Klauke Werkzeug entschieden haben und wünschen Ihnen viel Freude damit.

**2 Jahre
Garantie**

**Weltweiter
Werkzeug
Service
Klauke ASC**

Sie haben ein Qualitätsprodukt „Made in Germany“ erworben und erhalten 2 Jahre Garantie. Diese beginnt mit dem Kaufbedatum.

Um lange Freude und eine einwandfreie Funktion des Werkzeuges sicherzustellen, muss das Gerät spätestens beim Erreichen von 10.000 Arbeitsvorgängen oder nach 3 Jahren durch ein Autorisiertes Service Center (ASC) gewartet werden. Wird das Wartungsintervall von 10.000 Arbeitsvorgängen nicht eingehalten, erlischt der Garantieanspruch.

Im Rahmen dieser Wartung werden verschlissene Teile ersetzt und sicherheitsrelevante Teile geprüft und ggf. vorbeugend ersetzt.

Darüber hinaus empfehlen wir das Gerät jährlich zur Überprüfung an das zuständige ASC einzusenden.

Für Fragen rund um unseren Werkzeugservice oder eine Frage zu einem bestimmten Anwendungsfall stehen wir Ihnen persönlich unter der kostenlosen 0800-4685528 zur Verfügung.



Ihr Klauke Team

Thank you for choosing a Klauke tool. We hope it gives you lots of pleasure.

**2 years
Warranty**

**World wide
Tool
Service
Klauke ASC**

You have purchased a quality product „Made in Germany“, which is covered by a 2 year warranty. The warranty commences from the purchase receipt date.

To ensure lasting enjoyment and a flawless tool function, the product must be serviced by an Authorised Service Center (ASC) after 10,000 operations or after 3 years. Should the service Interval exceed 10.000 cycles the warranty claim is void.

The Service includes predictive maintenance in which worn-out parts will be replaced and safety relevant parts checked/replaced.

We recommend to have the tools checked yearly through an Authorized Service Center (ASC).

If you have any questions about our tool service or about a specific application, please go to <http://www.klauke.com/en/support/tool-service/>



Your Klauke team



- Icons: G, AUTO, QUICK STOP, 1, 2
- Icons: LED, Energy Save, easy, power button
- Icons: MAN, ELECTRONIC, SERVICE, PDF, IPS
- Icons: Bluetooth, REAL TIME, 2K
- Icon: Display



! WARNING

Read all safety warnings, instructions, illustrations and specifications provided with this power tool. Failure to follow all instructions listed below may result in electric shock, fire and/or serious injury. Save all warnings and instructions for future reference.

datecode

Year	Code	Month	Code	Month	Code
2018	M	Jan.	N	July	V
2019	N	Feb.	P	Aug.	W
2020	P	Mar.	Q	Sept.	X
2021	Q	Apr.	R	Oct.	Y
2022	R	May	S	Nov.	Z
2023	S	June	T	Dec.	1

batch# e.g. 304711
 datecode e.g. P = 2020; R = April
 consecutive# e.g. „142“ = tool # 142

FCC ID: RFRM842 • IC: 4957A-M842
 Model: CFM

This device complies with Part 15 of the FCC Rules and with Industry Canada licence-exempt RSS standard(s). Operation is subject to the following two conditions: (1) this device may not cause harmful interference, and (2) this device must accept any interference received, including interference that may cause undesired operation.

HE.18055_D

304711 PR 142

Klauke Auf dem Knapp 46 D-42855 Remscheid

2 years Warranty World wide Tool Service

ACHTUNG! Bei Beschädigung Garantieverlust! ATTENTION! Warranty seal if broken loses of Warranty

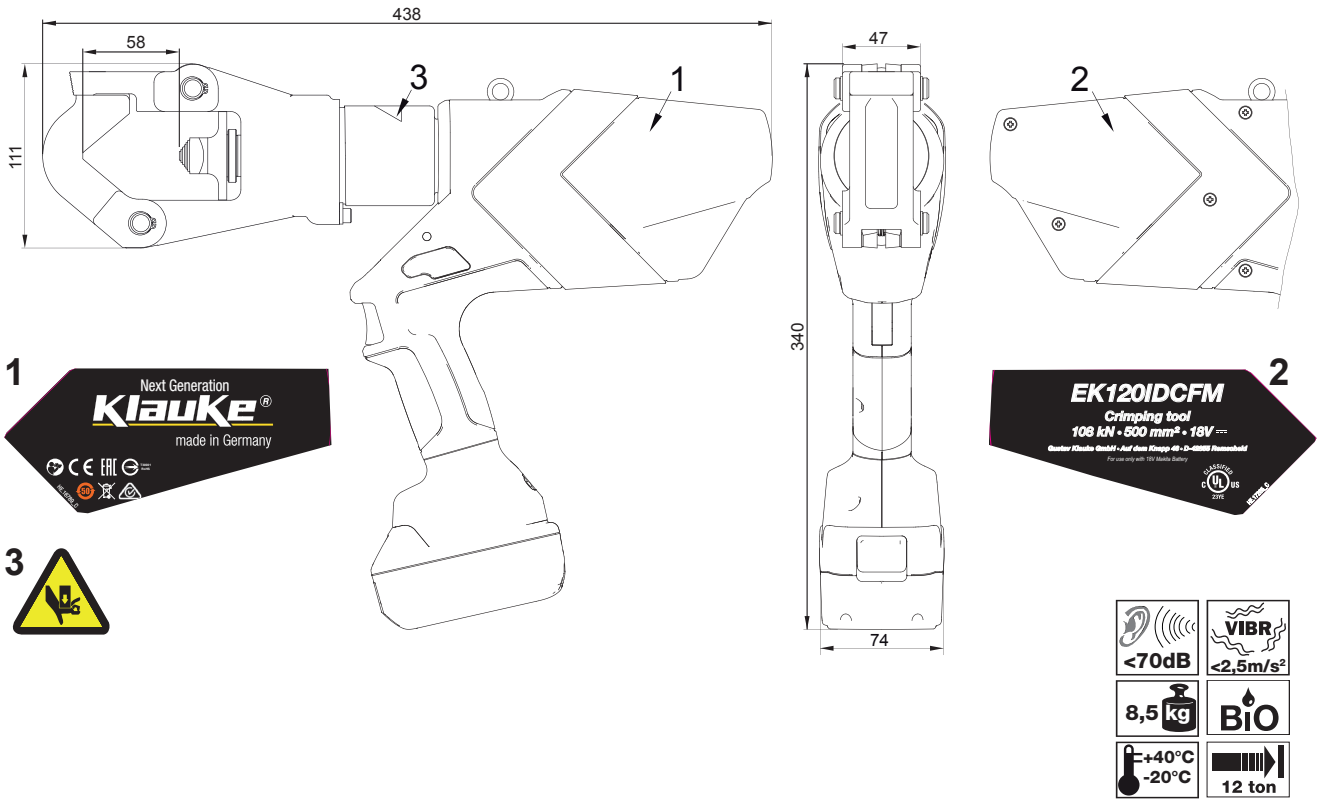

Use tool only with 18V Makita Battery

	Makita BL1840 18V 4.0Ah 72Wh	Makita Li-ion BL1830 18V 3.0Ah 54Wh	Makita Li-ion BL1815 18V 24Wh	
	Makita BL1850 18V 5.0Ah 90Wh			
	BL1850(B) 45 min. RAL4	BL1840(B) 36 min. RAL40	BL1830(B) 22 min. RAL2	
	BL1815 15 min. RAL1	10 - 40°C		

Alle Bedienungsanleitungen auch unter www.klauke.de abrufbar
All manuals are also available on www.Klauke.com

Makita DC18RC T

Prim.: 220V - 240V ~ 240W 50 - 60Hz
Sek.: 7.2V - 18V ~ 9A

0505611

T4A

CH.P/N:630718-5

Makita Corporation





 **350°** 

Klauke ASC
Authorised Service Center









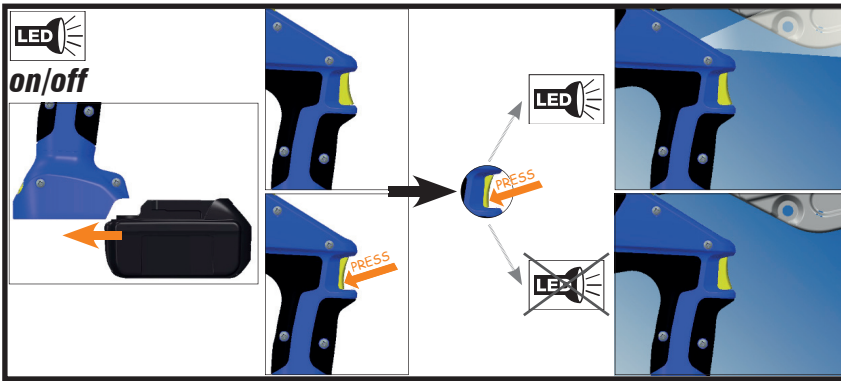
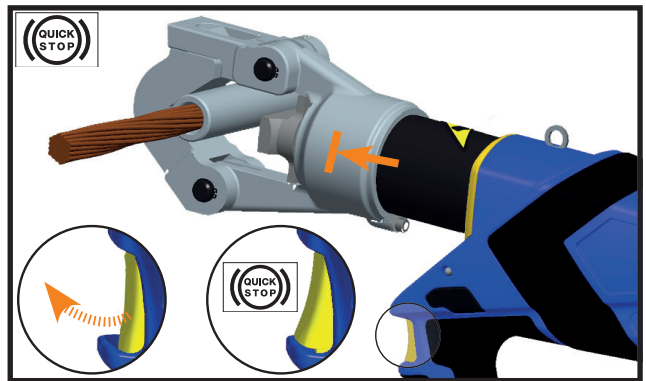
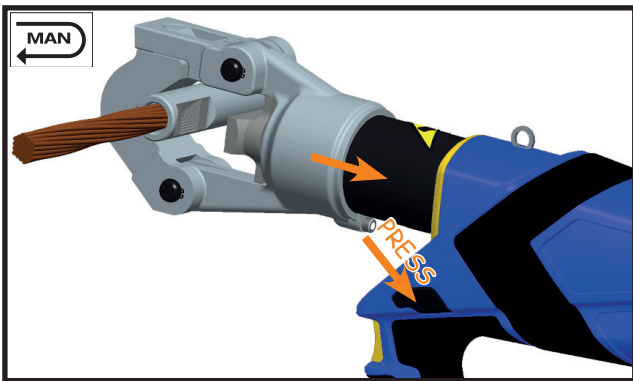
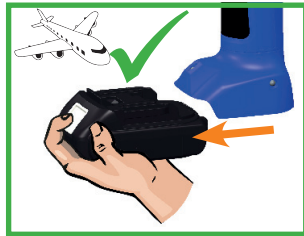
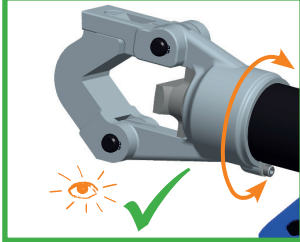

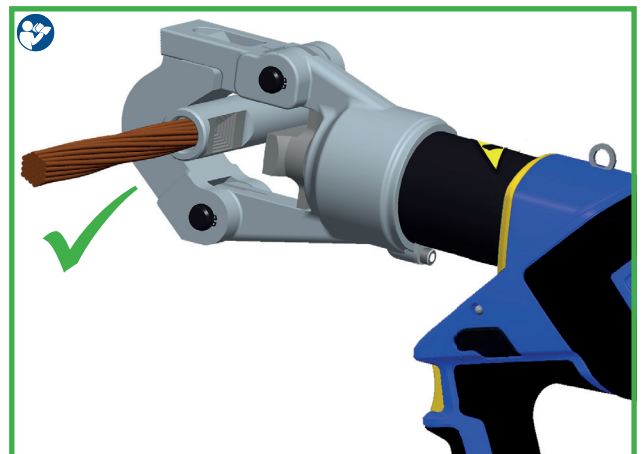
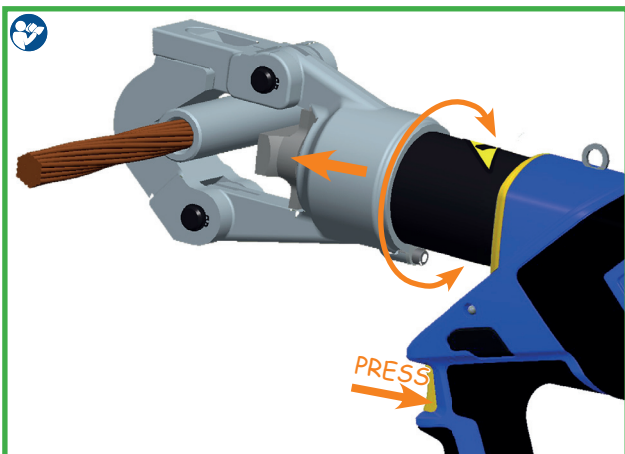
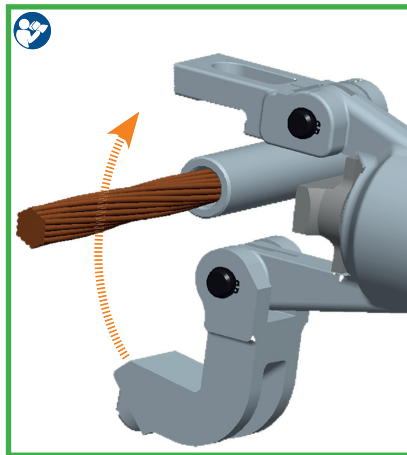
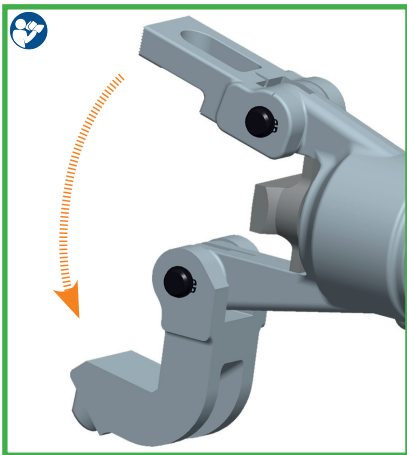
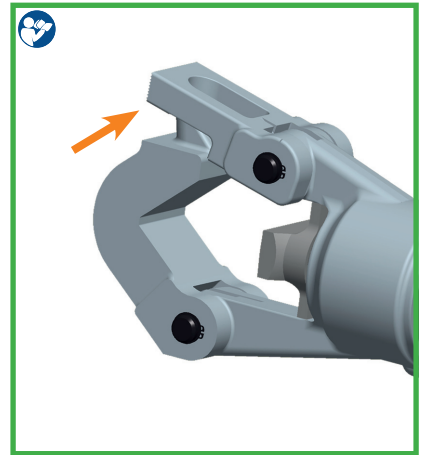
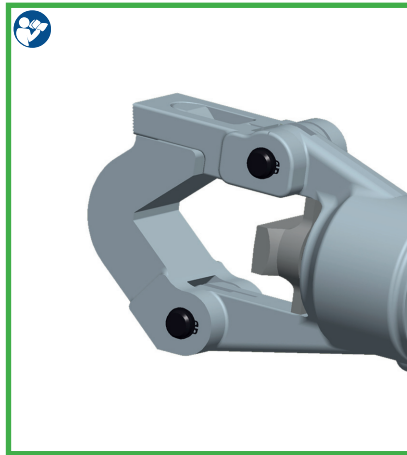







30% max. 











<p>1 </p>		<p>5 </p> <p>NEXT SERVICE: 9826 0Ps Cycles (until next service)</p>	<p>*1 Error codes: 1 Overcurrent fuse 2 Overcurrent comparator 3 Overheat board 4 Overheat battery 5 Battery empty, operation stop 6 Faulty crimp motor in operation 7 Faulty crimp motor not in operation 8 Low battery 9 Battery empty 10 RTC battery low 11 Tool deactivated 12 Service necessary 13 RTC not found 14 BT unit not found 16 Pressure sensor not found 17 Burst pressure exceeded 18 Battery temperature too low</p> <p>1 Überstrom durch Überstromsicherung 2 Überstrom durch Komparator 3 Boardtemperatur zu hoch 4 Akkutemperatur zu hoch 5 Akkuspannung während der Operation zu gering 6 Fehlpressung bei laufendem Motor 7 Fehlpressung bei stehendem Motor 8 Niedrige Akkuspannung 9 Akku leer 10 RTC-Batterie leer 11 Werkzeug deaktiviert 12 Service nötig 13 RTC nicht verfügbar 14 BT-Modul nicht verfügbar 16 Drucksensor nicht verfügbar 17 Berstdruck überschritten 18 Akkutemperatur zu gering</p>
<p>2 </p>	<p>Klauke®</p>	<p>6 </p> <p>TOTAL: t = 0.07 h Since manufacturing: Q = 21.12 Ah operating hours n = 174 Capacity # crimps</p>	
<p>ERROR CODE: Error code *1 ****</p>	<p>BT  P 3 bar Ṗ 3 bar</p>	<p>7 </p> <p>RETURN</p>	
<p>3 </p>	<p>Bluetooth (if connected) Battery charging level Current pressure Pressure max. *2</p>		
<p>4a </p>	<p>USER 3: RDE Doppelklick Doubleclick</p>		
<p>4b  3 sec.</p>	<p>USER SELECT 3: RDE Einfachklick Singleclick enter menu</p>		
<p>4c </p>	<p>USER SELECT: RDE Doppelklick Doubleclick select</p>		
<p>4d </p>	<p>USER SELECT: RDE Doppelklick Doubleclick confirmed</p>		

Klauke i-press® Software
www.klauke.com/connectivity

Klauke i-press® App

Download on the App Store

ANDROID APP ON Google play

<p> ≤ 20 sec. </p>	<p> ✓</p>
<p> > 20 sec.  ≤ 20 sec. </p> <p>REPEAT</p>	<p> ✓</p>

Le présent appareil est conforme aux CNR d'Industrie Canada applicables aux appareils radio exempts de licence. L'exploitation est autorisée aux deux conditions suivantes:
 (1) l'appareil ne doit pas produire de brouillage, et
 (2) l'utilisateur de l'appareil doit accepter tout brouillage radioélectrique subi, même si le brouillage est susceptible d'en compromettre le fonctionnement.

NOTICE:

Changes or modifications made to this equipment not expressly approved by Klauke may void the FCC authorization to operate this equipment.



BEFORE WORK

DIN EN 50110

2 years Warranty
World wide Tool Service

1. OIL
2. [Hand icon]
3. [Arrow icon]

Klauke

once a year

Klauke ASC
Authorised Service Center

3 years or 10.000 operations

Klauke ASC
Authorised Service Center

OLD PART REPLACEMENT SAFETY NEW

2 years Warranty
World wide Tool Service

WEEE 2012/19/EU

klauke-weee-abholung@emerson.com

Klauke ASC
Authorised Service Center



SERVICE 	LED 		Wann/When/Quand/Quando/ cuándo/Wanneer/Когда/это происходит/Kiedy/quando	Warum/Why/Pourquoi/Porquê/ ¿por qué?/Waarom/Причина/ Dlaczego/Perché
 20 sec			nach Arbeitsvorgang after working cycle après opération de travail Después del proceso de trabajo após o processo de trabalho na bedrijfscyclus после цикла опрессовки po zakończeniu pracy dopo il processo di lavoro	
 20 sec/2Hz			nach Arbeitsvorgang after working cycle après opération de travail Después del proceso de trabajo após o processo de trabalho na bedrijfscyclus после цикла опрессовки po zakończeniu pracy dopo il processo di lavoro	Klauke ASC Authorized Service Center
 20 sec/5Hz			während der Übertemperatur while exceeding the temp. limit pendant surchauffe en caso de temperatura excesiva durante a temperatura excessiva tijdens te hoge temperatuur при высокой температуре внутри корпуса przy przegrzaniu superando il limite di temperatura	Werkzeug zu heiß Unit too hot outil surchauffé Herramienta demasiado caliente ferramenta demasiado quente gereedschap te heet Перегрев инструмента urządzenie za gorące Utensile troppo caldo
 1 x	 1 x		nach Arbeitsvorgang after working cycle après opération de travail Después del proceso de trabajo após o processo de trabalho na bedrijfscyclus после цикла опрессовки po zakończeniu pracy dopo il processo di lavoro	Fehler: der notwendige Pressdruck wurde nicht erreicht. Es handelt sich um eine manuelle Unterbrechung der Pressung bei stehendem Motor. Error: the required pressure has not been reached. The operator has interrupted the pressing cycle manually while the motor was not running. ERREUR: Pression nécessaire pas atteinte. Il s'agit d'une interruption manuelle de la sertissage au moteur arrêté. Error: No se ha alcanzado la presión necesaria o el operador ha interrumpido el ciclo a mano mientras el motor ha parado. Falha: a pressão de prensagem necessária não foi alcançada. Trata-se de uma interrupção manual da prensagem com o motor parado. Foutmelding: De benodigde persdruk wordt niet bereikt. De gebruiker heeft de verkramping handmatig stopgezet aangezien de motor niet actief is. Ошибка: не было достигнуто требуемое усилие опрессовки или оператор прервал процесс опрессовки вручную, когда двигатель остановился. Błąd: konieczne ciśnienie nie zostało osiągnięte. Użytkownik przerwał cykl pracy ręcznie w chwili, gdy silnik nie był włączony Errore: la pressione richiesta non è stata raggiunta. L'operatore ha interrotto manualmente il ciclo di pressatura mentre il motore non è in funzione.
 3 x	 3 x		nach Arbeitsvorgang after working cycle après opération de travail Después del proceso de trabajo após o processo de trabalho na bedrijfscyclus после цикла опрессовки po zakończeniu pracy dopo il processo di lavoro	Schwerwiegender Fehler: Pressdruck wurde bei laufendem Motor nicht erreicht. Serious Error: The pressure has not been reached while the motor was running. Erreur Grave: Pression pas atteinte au moteur courant. Error grave: No se ha alcanzado presión mientras el motor estaba en marcha Falha grave: a pressão de prensagem não foi alcançada com o motor em funcionamento. Urgente foutmelding: De persdruk werd bij een werkende motor niet bereikt. Серьезная ошибка: не было достигнуто требуемое усилие опрессовки во время работы двигателя Poważny błąd: konieczne ciśnienie nie zostało osiągnięte podczas pracy silnika Errore grave: la pressione non è stata raggiunta mentre il motore è in funzione.





Klauke® Crimp Chart 120IDL tool series

Indent crimps

Klauke R-series Copper connector type	Ring type	Angle type 90°	Angle type 45°
Copper lugs R-series (Class 2 & 5)	5Rxx - 14Rxx	45Rxx - 54Rxx	45Rxx45 - 54Rxx45
Copper slices R-series (Class 2 & 5)			
T-splices R-series (Class 2 & 5)			
Cross-Splices (Class 2 & 5)			
Lugs for switch gear connections (Class 2 & 5)	5SGxx - 13SGxx		
Klauke L-series Copper connector type	Ring type	Angle type 90°	Angle type 45°
Copper lugs L-series (Class 2, 5 & 6)	L35xxxx - L400xxxx	L35890xx - L400890xxx	L35845xx - L400845xxx
Copper slices L-series (Class 2, 5 & 6)			
Klauke NDC-series Copper connector type	Ring type	Fork type	Pin type
Copper lugs NDC-series (Class 2 & 5)	NDC35-400		
Number of crimps*: 35 mm ² - 400 mm ² = 1 crimp			

* see chart in main catalog



HE-21690_B

Handgeführtes Elektrowerkzeug Typ EK 120IDCFM

(D) CE-17 - Konformitätserklärung. Wir erklären in alleiniger Verantwortlichkeit, daß dieses Produkt mit den folgenden Normen oder normativen Dokumenten übereinstimmt:

EN 62841-1, EN ISO 12100, EN ISO 13857, EN 349, EN 28662-1, EN 61000-6-3, EN 61000-6-2, EN 60529, EN 1037 gemäß den Bestimmungen der Richtlinien 2006/42/EG, 2014/30/EU, 2011/65/EU

(GB) CE-17 - Declaration of conformity. We declare under our sole responsibility that this product is in conformity with the following standards or normative documents:

EN 62841-1, EN ISO 12100, EN ISO 13857, EN 349, EN 28662-1, EN 61000-6-3, EN 61000-6-2, EN 60529, EN 1037 in accordance with the regulations of directives 2006/42/EG, 2014/30/EU, 2011/65/EU

(F) CE-17 - Déclaration de conformité. Nous déclarons sous notre seule responsabilité que ce produit est en conformité avec les normes ou documents normatifs suivants:

EN 62841-1, EN ISO 12100, EN ISO 13857, EN 349, EN 28662-1, EN 61000-6-3, EN 61000-6-2, EN 60529, EN 1037 conformément aux réglementations des directives 2006/42/EG, 2014/30/EU, 2011/65/EU

(E) CE-17 - Declaración de conformidad. Declaramos bajo nuestra sola responsabilidad que este producto está en conformidad con las normas o documentos normativos siguientes:

EN 62841-1, EN ISO 12100, EN ISO 13857, EN 349, EN 28662-1, EN 61000-6-3, EN 61000-6-2, EN 60529, EN 1037 de acuerdo con las regulaciones de las directivas 2006/42/EG, 2014/30/EU, 2011/65/EU

(I) CE-17 - Dichiarazione di conformità. Dichiariamo sotto la nostra esclusiva responsabilità che questo prodotto è conforme alle seguenti norme e documenti normativi:

EN 62841-1, EN ISO 12100, EN ISO 13857, EN 349, EN 28662-1, EN 61000-6-3, EN 61000-6-2, EN 60529, EN 1037 conformemente alle disposizioni delle direttive 2006/42/EG, 2014/30/EU, 2011/65/EU

(P) CE-17 - Declaração de conformidade. Declaramos sob nossa exclusiva responsabilidade que este produto cumpre as seguintes normas ou documentos normativos:

EN 62841-1, EN ISO 12100, EN ISO 13857, EN 349, EN 28662-1, EN 61000-6-3, EN 61000-6-2, EN 60529, EN 1037 conforme as disposições das directivas 2006/42/EG, 2014/30/EU, 2011/65/EU

(NL) CE-17 - Konformiteitsverklaring. Wij verklaren en wij stellen ons er alleen voor verantwoordelijk dat dit product voldoet aan de volgende normen of normatieve documenten:

EN 62841-1, EN ISO 12100, EN ISO 13857, EN 349, EN 28662-1, EN 61000-6-3, EN 61000-6-2, EN 60529, EN 1037 overeenkomstig de bepalingen van de richtlijnen 2006/42/EG, 2014/30/EU, 2011/65/EU

(GR) CE-17 - ΔΗΛΩΣΗ ΣΥΜΜΟΡΦΩΣΗΣ Μ. ε αναληψη συνολικης δηλωνμε: οτι το πορον προιον συμφωνει με τα παρακατω ποστυπα και με τα ηροτυπα ηου αναφερονται στα σχετικο εγγραφα

EN 62841-1, EN ISO 12100, EN ISO 13857, EN 349, EN 28662-1, EN 61000-6-3, EN 61000-6-2, EN 60529, EN 1037 συμφωνα με τοχς κουνισμους 2006/42/EG, 2014/30/EU, 2011/65/EU

(S) CE-17 - Konformitetsdeklaration. Vi förklarar på eget ansvar att denna produkt överensstämmer med följande normer eller normativa dokument:

EN 62841-1, EN ISO 12100, EN ISO 13857, EN 349, EN 28662-1, EN 61000-6-3, EN 61000-6-2, EN 60529, EN 1037 enligt bestämmelserna i direktiverna 2006/42/EG, 2014/30/EU, 2011/65/EU

(DK) CE-17 - Konformitetserklæring. Vi erklærer under almindeligt ansvar at dette produkt er i overensstemmelse med følgende normer eller normative dokumenter:

EN 62841-1, EN ISO 12100, EN ISO 13857, EN 349, EN 28662-1, EN 61000-6-3, EN 61000-6-2, EN 60529, EN 1037 i henhold til bestemmelse i direktiverne 2006/42/EØF, 2014/30/EU, 2011/65/EU

(N) CE-17 - Konformitetserklæring. Vi erklærer på eget ansvarlighet at dette produkt er i overensstemmelse med følgende standarder eller standard-dokumenter:

EN 62841-1, EN ISO 12100, EN ISO 13857, EN 349, EN 28662-1, EN 61000-6-3, EN 61000-6-2, EN 60529, EN 1037 i henhold til bestemmelse i direktive ne 2006/42/EØF, 2014/30/EU, 2011/65/EU

(FIN) CE-17 - Todistus standardinmukaisuudesta. Asiasta vastaavana todistamme täten, että tämä tuote on seuraavien standardien ja standardoimisasiakirjojen vaatimusten mukainen:

EN 62841-1, EN ISO 12100, EN ISO 13857, EN 349, EN 28662-1, EN 61000-6-3, EN 61000-6-2, EN 60529, EN 1037 ja vastaa säädöksiä 2006/42/EG, 2014/30/EU, 2011/65/EU

(SK) CE-17 - Prehlásenie o zhode. Prehlasujeme na vlastnú zodpovednosť, že tieto produkty sú v súlade s nasledovnými normami: EN 62841-1, EN ISO 12100, EN ISO 13857, EN 349, EN 28662-1, EN 61000-6-3, EN 61000-6-2, EN 60529, EN 1037 a v zhode so smernicami 2006/42/EG, 2014/30/EU, 2011/65/EU

(PL) CE-17 - Zgodność z dyrektywami CE. Świadomi odpowiedzialności oświadczamy, że niniejszy produkt jest zgodny z następującymi normami lub dokumentacją normatywną:

EN 62841-1, EN ISO 12100, EN ISO 13857, EN 349, EN 28662-1, EN 61000-6-3, EN 61000-6-2, EN 60529, EN 1037 zgodnie z postanowieniami wytycznych 2006/42/EG, 2014/30/EU, 2011/65/EU

(CZ) CE-17 - Prohlášení o shode. Prohlašujeme na vlastní zodpovednosť, že tyto produkty splňují následující normy nebo normativní listiny:

EN 62841-1, EN ISO 12100, EN ISO 13857, EN 349, EN 28662-1, EN 61000-6-3, EN 61000-6-2, EN 60529, EN 1037; Ve shode se směrnicemi 2006/42/EG, 2014/30/EU, 2011/65/EU

(SLO) CE-17 - Izjava o skladnosti. S tem potrjujemo splošno odgovornost, da je ta izdelek narejen v skladu z navedenimi normami in standardi: EN 62841-1, EN ISO 12100, EN ISO 13857, EN 349, EN 28662-1, EN 61000-6-3, EN 61000-6-2, EN 60529, EN 1037 ter določbami in smernicami 2006/42/EG, 2014/30/EU, 2011/65/EU

(HR) CE-17 - Izjava o skladnosti. Pod punom odgovornošću izjavljujemo da je proizvod naveden u naslovu ovog dokumenta sukladan sa primijenjenim normama i normativnim dokumentima:

EN 62841-1, EN ISO 12100, EN ISO 13857, EN 349, EN 28662-1, EN 61000-6-3, EN 61000-6-2, EN 60529, EN 1037 u skladu sa odredbama preporuka 2006/42/EG, 2014/30/EU, 2011/65/EU

(H) CE-17 - Megfelelősségi nyilatkozat. Kéziműködtetésű elektromos kéziszerszámok: Teljes felelősséggel kijelentjük, hogy ezek a termékek a következő szabványokkal és irányelvekkel összhangban vannak:

EN 62841-1, EN ISO 12100, EN ISO 13857, EN 349, EN 28662-1, EN 61000-6-3, EN 61000-6-2, EN 60529, EN 1037; és megfelelnek a rendeltetés szerinti 2006/42/EG, 2014/30/EU, 2011/65/EU irányelveknek.

(RO) CE-17 - Declarație de conformitate. Noi declarăm pe propria răspundere că acest produs este în conformitate cu următoarele norme și documente normative:

EN 62841-1, EN ISO 12100, EN ISO 13857, EN 349, EN 28662-1, EN 61000-6-3, EN 61000-6-2, EN 60529, EN 1037; potrivit dispozițiilor directivei 2006/42/EG, 2014/30/EU, 2011/65/EU

Remscheid, den 02.11.2017



Joh. - Christoph Schütz

Dipl.-Ing. Joh.-Christoph Schütz, CE-Beauftragter

Handgeführtes Elektrowerkzeug Typ EK 120IDCFM

(D) CE-17 - Konformitätserklärung **RED**. Wir erklären in alleiniger Verantwortlichkeit, daß dieses Produkt mit den folgenden Normen oder normativen Dokumenten übereinstimmt:

EN 60950-1, EN 301489-1, EN 301489-17, EN 300328 V2.1.1, EN 62479 gemäß den Bestimmungen der Richtlinien 2014/53/EU, 2011/65/EU

(GB) CE-17 - Declaration of conformity **RED**. We declare under our sole responsibility that this product is in conformity with the following standards or normative documents:

EN 60950-1, EN 301489-1, EN 301489-17, EN 300328 V2.1.1, EN 62479 in accordance with the regulations of directives 2014/53/EU, 2011/65/EU

(F) CE-17 - Déclaration de conformité **RED**. Nous déclarons sous notre seule responsabilité que ce produit est en conformité avec les normes ou documents normatifs suivants:

EN 60950-1, EN 301489-1, EN 301489-17, EN 300328 V2.1.1, EN 62479 conformément aux réglementations des directives 2014/53/EU, 2011/65/EU

(E) CE-17 - Declaración de conformidad **RED**. Declaramos bajo nuestra sola responsabilidad que este producto está en conformidad con las normas o documentos normativos siguientes:

EN 60950-1, EN 301489-1, EN 301489-17, EN 300328 V2.1.1, EN 62479 de acuerdo con las regulaciones de las directivas 2014/53/EU, 2011/65/EU

(I) CE-17 - Dichiarazione di conformità **RED**. Dichiariamo sotto la nostra esclusiva responsabilità che questo prodotto è conforme alle seguenti norme e documenti normativi:

EN 60950-1, EN 301489-1, EN 301489-17, EN 300328 V2.1.1, EN 62479 conformemente alle disposizioni delle direttive 2014/53/EU, 2011/65/EU

(P) CE-17 - Declaração de conformidade **RED**. Declaramos sob nossa exclusiva responsabilidade que este produto cumpre as seguintes normas ou documentos normativos:

EN 60950-1, EN 301489-1, EN 301489-17, EN 300328 V2.1.1, EN 62479 conforme as disposições das directivas 2014/53/EU, 2011/65/EU

(NL) CE-17 - Konformiteitsverklaring **RED**. Wij verklaren en wij stellen ons er alleen voor verantwoordelijk dat dit product voldoet aan de volgende normen of normatieve documenten:

EN 60950-1, EN 301489-1, EN 301489-17, EN 300328 V2.1.1, EN 62479 overeenkomstig de bepalingen van de richtlijnen 2014/53/EU, 2011/65/EU

(GR) CE-17 - ΔΗΛΩΣΗ ΣΥΜΜΟΡΦΩΣΗΣ Μ **RED**. ε αναληψη συνολικης δηλωνομε οτι το πορον προιον συμφωνει με τα παρακατω ποστυπα και με τα ηροτυπα ηου αναφερονται στα σχεπκο εγγραφα

EN 60950-1, EN 301489-1, EN 301489-17, EN 300328 V2.1.1, EN 62479 συμφωνα με τοχς κονονισμοϋς 2014/53/EU, 2011/65/EU

(S) CE-17 - Konformitetsdeklaration **RED**. Vi förklarar på eget ansvar att denna produkt överensstämmer med följande normer eller normativa dokument:

EN 60950-1, EN 301489-1, EN 301489-17, EN 300328 V2.1.1, EN 62479 enligt bestämmelserna i direktiverna 2014/53/EU, 2011/65/EU

(DK) CE-17 - Konformitetserklæring **RED**. Vi erklærer under almindeligt ansvar at dette produkt er i overensstemmelse med følgende normer eller normative dokumenter:

EN 60950-1, EN 301489-1, EN 301489-17, EN 300328 V2.1.1, EN 62479 i henhold til bestemmelserne i direktiverne 2014/53/EU, 2011/65/EU

(N) CE-17 - Konformitetserklæring **RED**. Vi erklærer på eget ansvarlighet at dette produkt er i overensstemmelse med følgende standarder eller standard-dokumenter:

EN 60950-1, EN 301489-1, EN 301489-17, EN 300328 V2.1.1, EN 62479 i henhold til bestemmelserne i direktive ne 2014/53/EU, 2011/65/EU

(FIN) CE-17 - Todistus standardinmukaisuudesta **RED**. Asiasta vastavaan todistamme täten, että tämä tuote on seuraavien standardien ja standardoimisasiakirjojen vaatimusten mukainen:

EN 60950-1, EN 301489-1, EN 301489-17, EN 300328 V2.1.1, EN 62479 ja vastaa säädöksiä 2014/53/EU, 2011/65/EU

(SK) CE-17 - Prehlásenie o zhode **RED**. Prehlasujeme na vlastnú zodpovednosť, že tieto produkty sú v súlade s nasledovnými normami: EN 60950-1, EN 301489-1, EN 301489-17, EN 300328 V2.1.1, EN 62479 a v zhode so smernicami 2014/53/EU, 2011/65/EU

(PL) CE-17 - Zgodność z dyrektywami **RED**. Świadomi odpowiedzialności oświadczamy, że niniejszy produkt jest zgodny z następującymi normami lub dokumentacją normatywną: EN 60950-1, EN 301489-1, EN 301489-17, EN 300328 V2.1.1, EN 62479 zgodnie z postanowieniami wytycznych 2014/53/EU, 2011/65/EU

(CZ) CE-17 - Prohlášení o shode **RED**. Prohlašujeme na vlastní zodpovědnost, že tyto produkty splňují následující normy nebo normativní listiny: EN 60950-1, EN 301489-1, EN 301489-17, EN 300328 V2.1.1, EN 62479 Ve shode se smernicemi 2014/53/EU, 2011/65/EU

(SLO) CE-17 - Izjava o skladnosti **RED**. S tem potrjujemo splošno odgovornost, da je ta izdelek narejen v skladu z navedenimi normami in standardi

EN 60950-1, EN 301489-1, EN 301489-17, EN 300328 V2.1.1, EN 62479 ter določbami in smernicami 2014/53/EU, 2011/65/EU

(HR) CE-17 - Izjava o skladnosti **RED**. Pod punom odgovornošću izjavljujemo da je proizvod naveden u naslovu ovog dokumenta sukladan sa primijenjenim normama i normativnim dokumentima :

EN 60950-1, EN 301489-1, EN 301489-17, EN 300328 V2.1.1, EN 62479 u skladu sa odredbama preporuka 2014/53/EU, 2011/65/EU

(H) CE-17 - Megfelelősségi nyilatkozat **RED**. Kéziműködtetésű elektromos kéziszerszámok. Teljes felelősséggel kijelentjük, hogy ezek a termékek a következő szabványokkal és irányelvekkel összhangban vannak:

EN 60950-1, EN 301489-1, EN 301489-17, EN 300328 V2.1.1, EN 62479 és megfelelnek a rendeltetés 2014/53/EU, 2011/65/EU irányelveknek.

(RO) CE-17 - Declarație de conformitate **RED**. Noi declarăm pe propria răspundere că acest produs este în conformitate cu următoarele norme și documente normative:

EN 60950-1, EN 301489-1, EN 301489-17, EN 300328 V2.1.1, EN 62479 potrivit dispozițiilor directivelor 2014/53/EU, 2011/65/EU

Remscheid, den 02.11.2017



Joh. - Christoph Schütz

Dipl.-Ing. Joh.-Christoph Schütz, CE-Beauftragter