



[www.klauke.com](http://www.klauke.com)

# EK 135FTCFB



Serialnumber

HE.17253\_C © 05/2016 R&D-2



Gustav Klauke GmbH • Auf dem Knapp 46 • D-42855 Remscheid • Telefon ++49 +2191-907-0 • Telefax ++49 +2191-907-141 • [www.klauke.com](http://www.klauke.com)

**Klauke**®

**EMERSON**

Wir freuen uns, dass Sie sich für ein Klauke Werkzeug entschieden haben und wünschen Ihnen viel Freude damit.

**2 Jahre  
Garantie**

**Weltweiter  
Werkzeug  
Service**  
Klauke ASC

Sie haben ein Qualitätsprodukt „Made in Germany“ erworben und erhalten 2 Jahre Garantie. Diese beginnt mit dem Kaufbedatum.

Um lange Freude und eine einwandfreie Funktion des Werkzeuges sicherzustellen, muss das Gerät spätestens beim Erreichen von 10.000 Arbeitsvorgängen oder nach 3 Jahren durch ein autorisiertes Service Center (ASC) gewartet werden. Wird das Wartungsintervall von 10.000 Arbeitsvorgängen nicht eingehalten, erlischt der Garantieanspruch.

Im Rahmen dieser Wartung werden verschlissene Teile ersetzt und sicherheitsrelevante Teile geprüft und ggf. vorbeugend ersetzt.

Darüber hinaus empfehlen wir das Gerät jährlich zur Überprüfung an das zuständige ASC einzusenden.

Für Fragen rund um unseren Werkzeugservice oder eine Frage zu einem bestimmten Anwendungsfall stehen wir Ihnen persönlich unter der kostenlosen 0800-4685528 zur Verfügung.



Ihr Klauke Team

Thank you for choosing a Klauke tool. We hope it gives you lots of pleasure.

**2 years  
Warranty**

**World wide  
Tool  
Service**  
Klauke ASC

You have purchased a quality product „Made in Germany“, which is covered by a 2 year warranty. The warranty commences from the purchase receipt date.

To ensure lasting enjoyment and a flawless tool function, the product must be serviced by an Authorised Service Center (ASC) after 10,000 operations or after 3 years. Should the service Interval exceed 10.000 cycles the warranty claim is void.

The Service includes predictive maintenance in which worn-out parts will be replaced and safety relevant parts checked/replaced.

We recommend to have the tools checked yearly through an Authorized Service Center (ASC).

If you have any questions about our tool service or about a specific application, please go to <http://www.klauke.com/en/support/tool-service/>



Your Klauke team

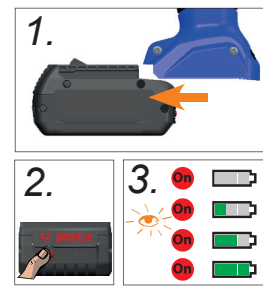

**⚠ WARNING**

Read all safety warnings, instructions, illustrations and specifications provided with this power tool. Failure to follow all instructions listed below may result in electric shock, fire and/or serious injury. Save all warnings and instructions for future reference.

datecode

Year	Code	Month	Code	Month	Code
2018	M	Jan.	N	July	V
2019	N	Feb.	P	Aug.	W
2020	P	Mar.	Q	Sept.	X
2021	Q	Apr.	R	Oct.	Y
2022	R	May	S	Nov.	Z
2023	S	June	T	Dec.	1

batch# e.g. 304711  
 datecode e.g. P = 2020; R = April  
 consecutive# e.g. „142“ = tool # 142



304711  
PR  
142

Klauke  
Auf dem Knapp 46  
D-42855  
Remscheid

2 years Warranty

World wide Tool Service

ACHTUNG! Bei Beschädigung des Garantiesiegels ist der Garantieanspruch erloschen. ATTENTION! Warranty seal if broken nullifies the Warranty.



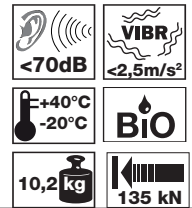
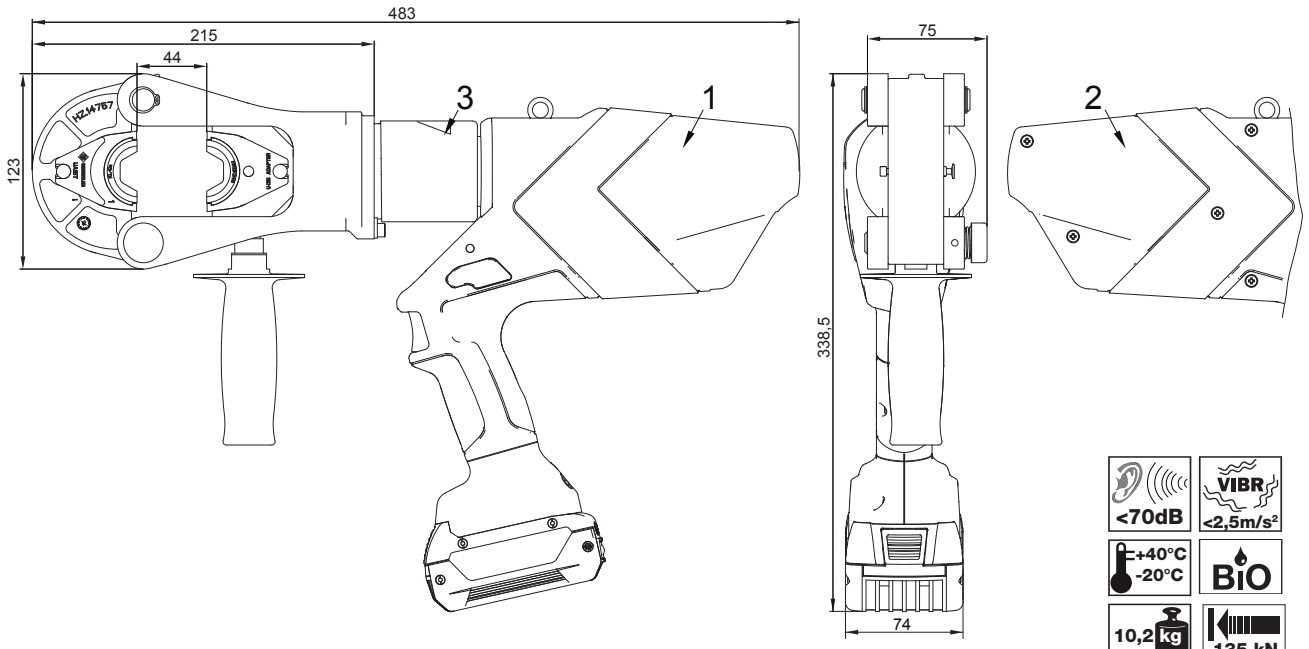

Use tool only with 18V Bosch Battery

**BOSCH**  
#1 609 92A 19R  
#1 609 92A 0F3

**Li-ion**

Loading Full

**BOSCH 18V 5,0Ah Li-Ion**

Ladegerät	GAL	GAL 1880 CV	
Sachnummer	2 607 225 ... 2 607 226 ...	2 607 225 9.. 2 607 226 0..	
Akku-Ladespannung (auto-matische Spannungserkennung) V <sub>eff</sub>	14,4–36	14,4–18	
Ladestrom A	8,0	8,0	
Zulässiger Ladetemperaturbereich °C	0–45	0–45	
Ladezeit bei Akku-Kapazität, ca.	(80%) 100%	(80%)	100%
– 1,3 Ah	min (10)	25 (10)	25
– 1,5 Ah	min (10)	25 (10)	25
– 2,0 Ah RALB1__ (36Wh)	min (15)	30 (15)	30
– 2,6 Ah	min (15)	30 (15)	30
– 3,0 Ah	min (20)	35 (20)	35
– 4,0 Ah	min (25)	35 (25)	35
– 5,0 Ah RALB2__ (90Wh)	min (35)	45 (35)	45
– 6,0 Ah	min (35)	50 (35)	50
Anzahl der Akkuzellen	4–30	4–10	
Gewicht entsprechend EPTA-Procedure 01:2014	kg 0,9	0,7	
Schutzklasse	□ / II	□ / II	

1.

2.

3.

Alle Bedienungsanleitungen auch unter [www.klauke.de](http://www.klauke.de) abrufbar  
All manuals are also available on [www.Klauke.com](http://www.Klauke.com)



**!**  $\angle > 350^\circ$  **STOP**

**Klauke ASC**  
Authorised Service Center

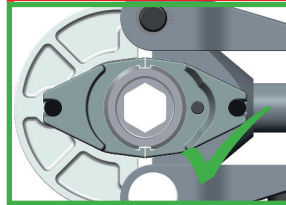
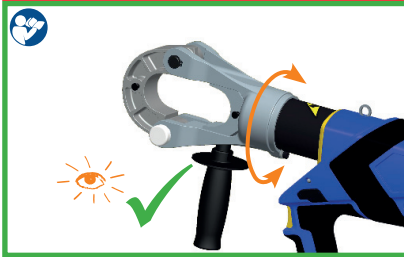
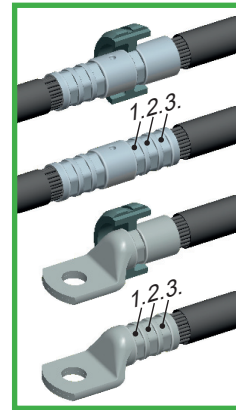
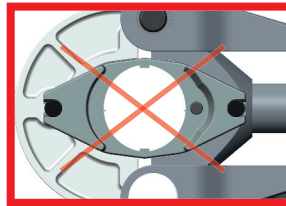

**!**

**30% max.** ✓

**LED on/off**

**LED**

**PRESS**

**LED**

**PRESS**

**MAN**

**PRESS**

**(QUICK STOP)**

**(QUICK STOP)**

**BEFORE WORK**

**DIN EN 50110**

**NO CHILDREN < 16 AT WORK**

**2 years Warranty**

**World wide Tool Service**

1. **OIL**

2. **Klauke**

3. **Klauke**

**Klauke**

**i**

**once a year**

**Klauke ASC**  
Authorised Service Center

**OLD PART REPLACEMENT**

**NEW SAFETY**

**3 years or 10.000 operations**

**Klauke ASC**  
Authorised Service Center

**2 years Warranty**

**World wide Tool Service**

**WEEE 2012/19/EU**

**klauke-weee-abholung@emerson.com**

**!**

**Klauke ASC**  
Authorised Service Center

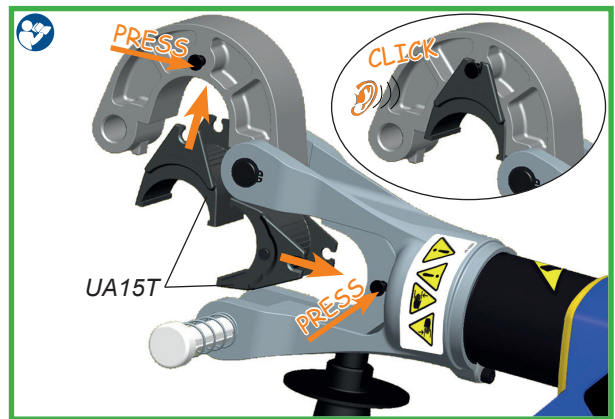
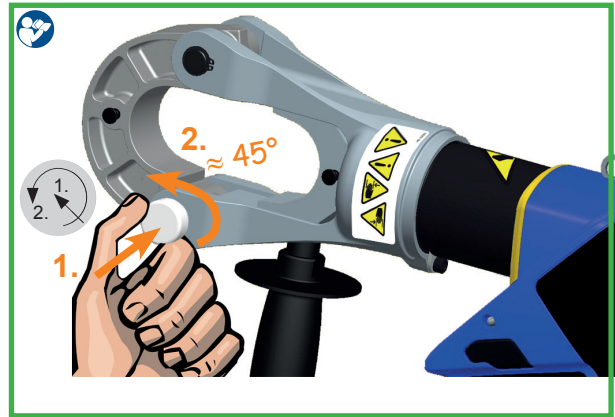
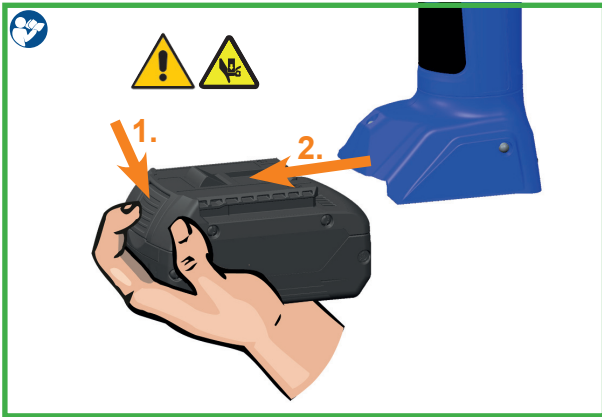



Artikel-Nr. Part No.		Erläuterung Explanation	Pressbereich Crimping range
UA15T		Adapter für die 13er Einsatzserie Adapter for the 13 series dies	<b>13</b> Klauke
HL15500		Einsatz für Kupfer Kabelschuhe Die for copper cable lug up	500 mm <sup>2</sup>
HL15630		Einsatz für Kupfer Kabelschuhe Die for copper cable lug up	630 mm <sup>2</sup>
HA15500		Einsatz für Aluminium Kabelschuhe Die for aluminium cable lugs	500 mm <sup>2</sup>
HA13400			400 mm <sup>2</sup>
HA13300			300 mm <sup>2</sup>





1			
2			
		ERROR CODE: *****	Error code *1
3a		BT P 3 bar P 3 bar	Bluetooth (if connected) Battery charging level Current pressure Pressure max. *2
3b		bar / psi	to change: bar / psi
3c		bar / psi	
3b		kN / lbf	to change: kN / lbf
3d		BT F 74 lbf F 369 lbf	
4a		USER 3: RD3 Doppelklick	Doubleclick
4b		USER SELECT 3: RD3 Einfachklick	Singleclick enter menu
4c		USER SELECT: RD3 Doppelklick	Doubleclick select
4d		USER SELECT: RD3 Doppelklick	Doubleclick confirmed
5		NEXT SERVICE: 9826 0Ps	Cycles (until next service)
6		TOTAL: t = 0.07 h Q = 21.12 Ah n = 174	Since manufacturing: operating hours Capacity # crimps
7			

\*1 Error codes:

- Overcurrent fuse
- Overcurrent comparator
- Overheat board
- Overheat battery
- Battery empty, operation stop
- Faulty crimp motor in operation
- Faulty crimp motor not in operation
- Low battery
- Battery empty
- RTC battery low
- Tool deactivated
- Service necessary
- RTC not found
- BT unit not found
- Pressure sensor not found
- Burst pressure exceeded
- Battery temperature too low

\*2 (2Hz)

**Klauke i-press® Software**  
[www.klauke.com/connectivity](http://www.klauke.com/connectivity)

**Klauke i-press® App**

Download on the App Store

ANDROID APP ON Google play

		$\leq 20 \text{ sec.}$							
		$> 20 \text{ sec.}$	<b>REPEAT</b>			$\leq 20 \text{ sec.}$			







SERVICE 	LED 		Wann/When/Quand/Quando/ cuándo/Wanneer/Когда/это происходит/Kiedy/quando	Warum/Why/Pourquoi/Porquê/ ¿por qué?/Waarom/Причина/ Dlaczego/Perché
 20 sec			nach Arbeitsvorgang after working cycle après opération de travail Después del proceso de trabajo após o processo de trabalho na bedrijfscyclus после цикла опрессовки po zakończeniu pracy dopo il processo di lavoro	
 20 sec/2Hz			nach Arbeitsvorgang after working cycle après opération de travail Después del proceso de trabajo após o processo de trabalho na bedrijfscyclus после цикла опрессовки po zakończeniu pracy dopo il processo di lavoro	<b>Klauke ASC</b> Authorized Service Center
 20 sec/5Hz			während der Übertemperatur while exceeding the temp. limit pendant surchauffe en caso de temperatura excesiva durante a temperatura excessiva tijdens te hoge temperatuur при высокой температуре внутри корпуса przy przegrzaniu superando il limite di temperatura	Werkzeug zu heiß Unit too hot outil surchauffé Herramienta demasiado caliente ferramenta demasiado quente gereedschap te heet Перегрев инструмента urządzenie za gorące Utensile troppo caldo 
 1 x	 1 x		nach Arbeitsvorgang after working cycle après opération de travail Después del proceso de trabajo após o processo de trabalho na bedrijfscyclus после цикла опрессовки po zakończeniu pracy dopo il processo di lavoro	Fehler: der notwendige Pressdruck wurde nicht erreicht. Es handelt sich um eine manuelle Unterbrechung der Pressung bei stehendem Motor. Error: the required pressure has not been reached. The operator has interrupted the pressing cycle manually while the motor was not running. ERREUR: Pression nécessaire pas atteinte. Il s'agit d'une interruption manuelle de la sertissage au moteur arrêté. Error: No se ha alcanzado la presión necesaria o el operador ha interrumpido el ciclo a mano mientras el motor ha parado. Falha: a pressão de prensagem necessária não foi alcançada. Trata-se de uma interrupção manual da prensagem com o motor parado. Foutmelding: De benodigde persdruk wordt niet bereikt. De gebruiker heeft de verkramping handmatig stopgezet aangezien de motor niet actief is. Ошибка: не было достигнуто требуемое усилие опрессовки или оператор прервал процесс опрессовки вручную, когда двигатель остановился. Błąd: konieczne ciśnienie nie zostało osiągnięte. Użytkownik przerwał cykl pracy ręcznie w chwili, gdy silnik nie był włączony Errore: la pressione richiesta non è stata raggiunta. L'operatore ha interrotto manualmente il ciclo di pressatura mentre il motore non è in funzione.
 3 x	 3 x		nach Arbeitsvorgang after working cycle après opération de travail Después del proceso de trabajo após o processo de trabalho na bedrijfscyclus после цикла опрессовки po zakończeniu pracy dopo il processo di lavoro	Schwerwiegender Fehler: Pressdruck wurde bei laufendem Motor nicht erreicht. Serious Error: The pressure has not been reached while the motor was running. Erreur Grave: Pression pas atteinte au moteur courant. Error grave: No se ha alcanzado presión mientras el motor estaba en marcha Falha grave: a pressão de prensagem não foi alcançada com o motor em funcionamento. Urgente foutmelding: De persdruk werd bij een werkende motor niet bereikt. Серьезная ошибка: не было достигнуто требуемое усилие опрессовки во время работы двигателя Poważny błąd: konieczne ciśnienie nie zostało osiągnięte podczas pracy silnika Errore grave: la pressione non è stata raggiunta mentre il motore è in funzione.





Tab. 2

geeignet für suitable for	13 Klauke	Verb. material Connection material	Pressbereich mm <sup>2</sup> Crimping range mm <sup>2</sup>	Press- form Crimping mold	Kennzeichnung Marking	
Rohrkabelschuhe und Verbinder - Cu (gelb chromatiert, Pressbreite 5 mm) Copper tubular cable lugs and connectors - Cu (chrome plated, crimping width 5 mm)					außen outside	Preßprofil Profile
Rohrkabelschuhe und Verbinder „Normalausführung“, Rohrkabel- schuhe für Schaltgeräteanschlüsse Tubular cable lugs and connectors, „standard type“, tubular cable lugs for switchgear connections			16 - 400		Cu, QS	QS
Isolierte Rohrkabelschuhe und Verbinder, Normalausführung Insulated cable lugs and compression joints, „standard type“			10 - 150		IS, QS	QS
Rohrkabelschuhe und Verbinder für feindrähtige Leiter Tubular cable lugs and connectors for fine stranded conductors			16 - 150		F, QS	QS
Presskabelschuhe und Verbinder nach DIN - Cu Compression cable lugs and connectors to DIN, copper						
Presskabelschuhe und Verbinder nach DIN - Cu Copper compression cable lugs and connectors to DIN		DIN	16 - 300		Cu, QS	Kennzahl
Doppelpresskabelschuhe Double compression cable lugs			2 x 50 - 2 x 95		DP, QS	QS
Quetschkabelschuhe, Verbinder und Stiftkabelschuhe nach DIN - Cu Solderless terminals, connectors and pin terminals to DIN, copper						
Quetschkabelschuhe (DIN 46234), Verbinder und Stiftkabelschuhe (DIN 46230) nach DIN - Cu Solderless terminals (DIN 46234), connectors and pin terminals (DIN 46230) acc. to DIN			16 - 150		Cu, QS, DIN 46234	QS
Isolierte Quetschkabelschuhe Insulated solderless terminals			10 - 95		ISQ, QS	QS
Hülsen für verdichtete Leiter und Sektorleiter - Cu Sleeves for compacted conductors and sector shaped conductors, copper						
Runddrückeinsätze für Al- und Cu-Sektorleiter Pre-rounding dies for sector-shaped Al and Cu conductors			10sm - 300sm		RU, QS, sm, QS, sm	--
Presskabelschuhe und Verbinder nach DIN - Al Compression cable lugs and connectors to DIN, aluminium						
Presskabelschuhe und Verbinder nach DIN - Al Aluminium compression cable lugs and connectors to DIN - Al			10 - 240			
Pressverbinder für zugfeste Verbindungen von Aldrey-Seilen nach DIN EN 50182, Al-Leiter DIN EN 50182, 120-185 mm <sup>2</sup> Compression joints for full-tension connections of Aldrey conductors acc. to DIN EN 50182, Al-conductors DIN EN 50182, 120-185 mm <sup>2</sup>		Al	25 - 185		Al, QS	Kennzahl
Pressverbinder nach DIN 48085, Teil 3 für Al-Seile DIN EN 50182 Compression joints to DIN 48085, part 3 for Al-cables DIN EN 50182			25 / 4 - 120 / 20			
Presskabelschuhe und Verbinder - Al/Cu Compression cable lugs and connectors, Al/Cu						
Presskabelschuhe und Verbinder - Al/Cu Compression cable lugs and connectors - Al/Cu		Al/Cu	10 - 240			
Klemmen und Schraubverbinder Clamps and screw connectors						
Abzweigklemmen C-Form C-clamps			10 - 70		C, QS	--
Abzweigklemmen H-Form H-clamps			70 - 120			
Aderendhülsen Cable end-sleeves						
Aderendhülsen Cable end-sleeves			25 - 240		AE, QS	--
Aderendhülsen Trapez-Sonderform für ausgedünnte („verdichtete“) feindrähtige Leiter Cable end-sleeves special trapezoid crimp for „compacted“ fine stranded conductors			25 - 240			
<i>QS = Querschnitt/Cross-section; IS = isolierte Rohrkabelschuhe/ pre-insulated tubular cable lugs;  F = feindrähtige Leiter/ compacted fine str. conductors; ISQ = isolierte Quetschkabelschuhe/ pre-insulated tubular cable lugs;  RU = Runddrückeinsätze/ pre-rounding dies; sm = Sektorleiter mehrdrähtig/ multistranded conductors; AE = Aderendhülsen/ wire ferrules  Bitte beachten Sie bei der Verpressung von Verbindern die Einschränkungen im technischen Anhang unseres Kataloges!  Please observe the restrictions in the technical index of our catalogue when crimping connectors!</i>						

## Handgeführtes Elektrowerkzeug Typ EK 135FTCFB

**(D)** CE-17 - Konformitätserklärung. Wir erklären in alleiniger Verantwortlichkeit, daß dieses Produkt mit den folgenden Normen oder normativen Dokumenten übereinstimmt:

EN 62841-1, EN ISO 12100, EN ISO 13857, EN 349, EN 28662-1, EN 61000-6-3, EN 61000-6-2, EN 60529, EN 1037 gemäß den Bestimmungen der Richtlinien 2006/42/EG, 2014/30/EU, 2011/65/EU

**(GB)** CE-17 - Declaration of conformity. We declare under our sole responsibility that this product is in conformity with the following standards or normative documents:

EN 62841-1, EN ISO 12100, EN ISO 13857, EN 349, EN 28662-1, EN 61000-6-3, EN 61000-6-2, EN 60529, EN 1037 in accordance with the regulations of directives 2006/42/EG, 2014/30/EU, 2011/65/EU

**(F)** CE-17 - Déclaration de conformité. Nous déclarons sous notre seule responsabilité que ce produit est en conformité avec les normes ou documents normatifs suivants:

EN 62841-1, EN ISO 12100, EN ISO 13857, EN 349, EN 28662-1, EN 61000-6-3, EN 61000-6-2, EN 60529, EN 1037 conformément aux réglementations des directives 2006/42/EG, 2014/30/EU, 2011/65/EU

**(E)** CE-17 - Declaración de conformidad. Declaramos bajo nuestra sola responsabilidad que este producto está en conformidad con las normas o documentos normativos siguientes:

EN 62841-1, EN ISO 12100, EN ISO 13857, EN 349, EN 28662-1, EN 61000-6-3, EN 61000-6-2, EN 60529, EN 1037 de acuerdo con las regulaciones de las directivas 2006/42/EG, 2014/30/EU, 2011/65/EU

**(I)** CE-17 - Dichiarazione di conformità. Dichiariamo sotto la nostra esclusiva responsabilità che questo prodotto è conforme alle seguenti norme e documenti normativi:

EN 62841-1, EN ISO 12100, EN ISO 13857, EN 349, EN 28662-1, EN 61000-6-3, EN 61000-6-2, EN 60529, EN 1037 conformemente alle disposizioni delle direttive 2006/42/EG, 2014/30/EU, 2011/65/EU

**(P)** CE-17 - Declaração de conformidade. Declaramos sob nossa exclusiva responsabilidade que este produto cumpre as seguintes normas ou documentos normativos:

EN 62841-1, EN ISO 12100, EN ISO 13857, EN 349, EN 28662-1, EN 61000-6-3, EN 61000-6-2, EN 60529, EN 1037 conforme as disposições das directivas 2006/42/EG, 2014/30/EU, 2011/65/EU

**(NL)** CE-17 - Konformiteitsverklaring. Wij verklaren en wij stellen ons er alleen voor verantwoordelijk dat dit product voldoet aan de volgende normen of normatieve documenten:

EN 62841-1, EN ISO 12100, EN ISO 13857, EN 349, EN 28662-1, EN 61000-6-3, EN 61000-6-2, EN 60529, EN 1037 overeenkomstig de bepalingen van de richtlijnen 2006/42/EG, 2014/30/EU, 2011/65/EU

**(GR)** CE-17 - ΔΗΛΩΣΗ ΣΥΜΜΟΡΦΩΣΗΣ Μ. ε αναληψη συνολικης δηλωνμε: οτι το πορον προιον συμφωνει με τα παρακατω ποστυπα και με τα ηροτυπα ηου αναφερονται στα σχετικο εγγραφα

EN 62841-1, EN ISO 12100, EN ISO 13857, EN 349, EN 28662-1, EN 61000-6-3, EN 61000-6-2, EN 60529, EN 1037 συμφωνα με τοχς κουνισμους 2006/42/EG, 2014/30/EU, 2011/65/EU

**(S)** CE-17 - Konformitetsdeklaration. Vi förklarar på eget ansvar att denna produkt överensstämmer med följande normer eller normativa dokument:

EN 62841-1, EN ISO 12100, EN ISO 13857, EN 349, EN 28662-1, EN 61000-6-3, EN 61000-6-2, EN 60529, EN 1037 enligt bestämmelserna i direktiverna 2006/42/EG, 2014/30/EU, 2011/65/EU

**(DK)** CE-17 - Konformitetserklæring. Vi erklærer under almindeligt ansvar at dette produkt er i overensstemmelse med følgende normer eller normative dokumenter:

EN 62841-1, EN ISO 12100, EN ISO 13857, EN 349, EN 28662-1, EN 61000-6-3, EN 61000-6-2, EN 60529, EN 1037 i henhold til bestemmelse i direktiverne 2006/42/EØF, 2014/30/EU, 2011/65/EU

**(N)** CE-17 - Konformitetserklæring. Vi erklærer på eget ansvarlighet at dette produkt er i overensstemmelse med følgende standarder eller standard-dokumenter:

EN 62841-1, EN ISO 12100, EN ISO 13857, EN 349, EN 28662-1, EN 61000-6-3, EN 61000-6-2, EN 60529, EN 1037 i henhold til bestemmelse i direktive ne 2006/42/EØF, 2014/30/EU, 2011/65/EU

**(FIN)** CE-17 - Todistus standardinmukaisuudesta. Asiasta vastaavana todistamme täten, että tämä tuote on seuraavien standardien ja standardoimisasiakirjojen vaatimusten mukainen:

EN 62841-1, EN ISO 12100, EN ISO 13857, EN 349, EN 28662-1, EN 61000-6-3, EN 61000-6-2, EN 60529, EN 1037 ja vastaa säädöksiä 2006/42/EG, 2014/30/EU, 2011/65/EU

**(SK)** CE-17 - Prehlásenie o zhode. Prehlasujeme na vlastnú zodpovednosť, že tieto produkty sú v súlade s nasledovnými normami: EN 62841-1, EN ISO 12100, EN ISO 13857, EN 349, EN 28662-1, EN 61000-6-3, EN 61000-6-2, EN 60529, EN 1037 a v zhode so smernicami 2006/42/EG, 2014/30/EU, 2011/65/EU

**(PL)** CE-17 - Zgodność z dyrektywami CE. Świadomi odpowiedzialności oświadczamy, że niniejszy produkt jest zgodny z następującymi normami lub dokumentacją normatywną:

EN 62841-1, EN ISO 12100, EN ISO 13857, EN 349, EN 28662-1, EN 61000-6-3, EN 61000-6-2, EN 60529, EN 1037 zgodnie z postanowieniami wytycznych 2006/42/EG, 2014/30/EU, 2011/65/EU

**(CZ)** CE-17 - Prohlášení o shode. Prohlašujeme na vlastní zodpovednosť, že tyto produkty splňují následující normy nebo normativní listiny:

EN 62841-1, EN ISO 12100, EN ISO 13857, EN 349, EN 28662-1, EN 61000-6-3, EN 61000-6-2, EN 60529, EN 1037; Ve shode se směrnicemi 2006/42/EG, 2014/30/EU, 2011/65/EU

**(SLO)** CE-17 - Izjava o skladnosti. S tem potrjujemo splošno odgovornost, da je ta izdelek narejen v skladu z navedenimi normami in standardi: EN 62841-1, EN ISO 12100, EN ISO 13857, EN 349, EN 28662-1, EN 61000-6-3, EN 61000-6-2, EN 60529, EN 1037 ter določbami in smernicami 2006/42/EG, 2014/30/EU, 2011/65/EU

**(HR)** CE-17 - Izjava o skladnosti. Pod punom odgovornošću izjavljujemo da je proizvod naveden u naslovu ovog dokumenta sukladan sa primijenjenim normama i normativnim dokumentima:

EN 62841-1, EN ISO 12100, EN ISO 13857, EN 349, EN 28662-1, EN 61000-6-3, EN 61000-6-2, EN 60529, EN 1037 u skladu sa odredbama preporuka 2006/42/EG, 2014/30/EU, 2011/65/EU

**(H)** CE-17 - Megfelelőségi nyilatkozat. Kéziműködtetésű elektromos kéziszerszámok: Teljes felelősséggel kijelentjük, hogy ezek a termékek a következő szabványokkal és irányelvekkel összhangban vannak:

EN 62841-1, EN ISO 12100, EN ISO 13857, EN 349, EN 28662-1, EN 61000-6-3, EN 61000-6-2, EN 60529, EN 1037; és megfelelnek a rendeltetés szerinti 2006/42/EG, 2014/30/EU, 2011/65/EU irányelveknek.

**(RO)** CE-17 - Declarație de conformitate. Noi declarăm pe propria răspundere că acest produs este în conformitate cu următoarele norme și documente normative:

EN 62841-1, EN ISO 12100, EN ISO 13857, EN 349, EN 28662-1, EN 61000-6-3, EN 61000-6-2, EN 60529, EN 1037; potrivit dispozițiilor directivei 2006/42/EG, 2014/30/EU, 2011/65/EU

Remscheid, den 02.11.2017



Joh. - Christoph Schütz

Dipl.-Ing. Joh.-Christoph Schütz, CE-Beauftragter

## Handgeführtes Elektrowerkzeug Typ EK 135FTCFB

**(D)** CE-17 - Konformitätserklärung **RED**. Wir erklären in alleiniger Verantwortlichkeit, daß dieses Produkt mit den folgenden Normen oder normativen Dokumenten übereinstimmt:

EN 60950-1, EN 301489-1, EN 301489-17, EN 300328 V2.1.1, EN 62479 gemäß den Bestimmungen der Richtlinien 2014/53/EU, 2011/65/EU

**(GB)** CE-17 - Declaration of conformity **RED**. We declare under our sole responsibility that this product is in conformity with the following standards or normative documents:

EN 60950-1, EN 301489-1, EN 301489-17, EN 300328 V2.1.1, EN 62479 in accordance with the regulations of directives 2014/53/EU, 2011/65/EU

**(F)** CE-17 - Déclaration de conformité **RED**. Nous déclarons sous notre seule responsabilité que ce produit est en conformité avec les normes ou documents normatifs suivants:

EN 60950-1, EN 301489-1, EN 301489-17, EN 300328 V2.1.1, EN 62479 conformément aux réglementations des directives 2014/53/EU, 2011/65/EU

**(E)** CE-17 - Declaración de conformidad **RED**. Declaramos bajo nuestra sola responsabilidad que este producto está en conformidad con las normas o documentos normativos siguientes:

EN 60950-1, EN 301489-1, EN 301489-17, EN 300328 V2.1.1, EN 62479 de acuerdo con las regulaciones de las directivas 2014/53/EU, 2011/65/EU

**(I)** CE-17 - Dichiarazione di conformità **RED**. Dichiariamo sotto la nostra esclusiva responsabilità che questo prodotto è conforme alle seguenti norme e documenti normativi:

EN 60950-1, EN 301489-1, EN 301489-17, EN 300328 V2.1.1, EN 62479 conformemente alle disposizioni delle direttive 2014/53/EU, 2011/65/EU

**(P)** CE-17 - Declaração de conformidade **RED**. Declaramos sob nossa exclusiva responsabilidade que este produto cumpre as seguintes normas ou documentos normativos:

EN 60950-1, EN 301489-1, EN 301489-17, EN 300328 V2.1.1, EN 62479 conforme as disposições das directivas 2014/53/EU, 2011/65/EU

**(NL)** CE-17 - Konformiteitsverklaring **RED**. Wij verklaren en wij stellen ons er alleen voor verantwoordelijk dat dit produkt voldoet aan de volgende normen of normatieve documenten:

EN 60950-1, EN 301489-1, EN 301489-17, EN 300328 V2.1.1, EN 62479 overeenkomstig de bepalingen van de richtlijnen 2014/53/EU, 2011/65/EU

**(GR)** CE-17 - ΔΗΛΩΣΗ ΣΥΜΜΟΡΦΩΣΗΣ Μ **RED**. ε αναληψη συνολικης δηλωνομε οτι το πορον προιον συμφωνει με τα παρακατω ποστυπα και με τα ηροτυπα ηου αναφερουνται στα σχεπκο εγγραφα

EN 60950-1, EN 301489-1, EN 301489-17, EN 300328 V2.1.1, EN 62479 συμφωνα με τοχς κονονισμους 2014/53/EU, 2011/65/EU

**(S)** CE-17 - Konformitetsdeklaration **RED**. Vi förklarar på eget ansvar att denna produkt överensstämmer med följande normer eller normativa dokument:

EN 60950-1, EN 301489-1, EN 301489-17, EN 300328 V2.1.1, EN 62479 enligt bestämmelserna i direktiverna 2014/53/EU, 2011/65/EU

**(DK)** CE-17 - Konformitetserklæring **RED**. Vi erklærer under almindeligt ansvar at dette produkt er i overensstemmelse med følgende normer eller normative dokumenter:

EN 60950-1, EN 301489-1, EN 301489-17, EN 300328 V2.1.1, EN 62479 i henhold til bestemmelserne i direktiverne 2014/53/EU, 2011/65/EU

**(N)** CE-17 - Konformitetserklæring **RED**. Vi erklærer på eget ansvarlighet at dette produkt er i overensstemmelse med følgende standarder eller standard-dokumenter:

EN 60950-1, EN 301489-1, EN 301489-17, EN 300328 V2.1.1, EN 62479 i henhold til bestemmelserne i direktive ne 2014/53/EU, 2011/65/EU

**(FIN)** CE-17 - Todistus standardinmukaisuudesta **RED**. Asiasta vastava todistamme täten, että tämä tuote on seuraavien standardien ja standardoimisasiakirjojen vaatimusten mukainen:

EN 60950-1, EN 301489-1, EN 301489-17, EN 300328 V2.1.1, EN 62479 ja vastaa säädöksiä 2014/53/EU, 2011/65/EU

**(SK)** CE-17 - Prehlásenie o zhode **RED**. Prehlasujeme na vlastnú zodpovednosť, že tieto produkty sú v súlade s nasledovnými normami:

EN 60950-1, EN 301489-1, EN 301489-17, EN 300328 V2.1.1, EN 62479 a v zhode so smernicami 2014/53/EU, 2011/65/EU

**(PL)** CE-17 - Zgodność z dyrektywami **RED**. Świadomi odpowiedzialności oświadczamy, że niniejszy produkt jest zgodny z następującymi normami lub dokumentacją normatywną: EN 60950-1, EN 301489-1, EN 301489-17, EN 300328 V2.1.1, EN 62479 zgodnie z postanowieniami wytycznych 2014/53/EU, 2011/65/EU

**(CZ)** CE-17 - Prohlášení o shode **RED**. Prohlasujeme na vlastní zodpovednosť, že tyto produkty splňují následující normy nebo normativní listiny: EN 60950-1, EN 301489-1, EN 301489-17, EN 300328 V2.1.1, EN 62479 Ve shode se smernicemi 2014/53/EU, 2011/65/EU

**(SLO)** CE-17 - Izjava o skladnosti **RED**. S tem potrjujemo splošno odgovornost, da je ta izdelek narejen v skladu z navedenimi normami in standardi

EN 60950-1, EN 301489-1, EN 301489-17, EN 300328 V2.1.1, EN 62479 ter določbami in smernicami 2014/53/EU, 2011/65/EU

**(HR)** CE-17 - Izjava o skladnosti **RED**. Pod punom odgovornošću izjavljujemo da je proizvod naveden u naslovu ovog dokumenta sukladan sa primijenjenim normama i normativnim dokumentima :

EN 60950-1, EN 301489-1, EN 301489-17, EN 300328 V2.1.1, EN 62479 u skladu sa odredbama preporuka 2014/53/EU, 2011/65/EU

**(H)** CE-17 - Megfelelősségi nyilatkozat **RED**. Kéziműködtetésű elektromos kéziszerszámok. Teljes felelősséggel kijelentjük, hogy ezek a termékek a következő szabványokkal és irányelvekkel összhangban vannak:

EN 60950-1, EN 301489-1, EN 301489-17, EN 300328 V2.1.1, EN 62479 és megfelelnek a rendeltetés 2014/53/EU, 2011/65/EU irányelveknek.

**(RO)** CE-17 - Declarație de conformitate **RED**. Noi declarăm pe propria răspundere că acest produs este în conformitate cu următoarele norme și documente normative:

EN 60950-1, EN 301489-1, EN 301489-17, EN 300328 V2.1.1, EN 62479 potrivit dispozițiilor directivelor 2014/53/EU, 2011/65/EU

Remscheid, den 02.11.2017



Joh. - Christoph Schütz

Dipl.-Ing. Joh.-Christoph Schütz, CE-Beauftragter