



www.klauke.com

EK 50/5CFB



Serialnumber

HE.16823_E © 050/2016 R&D-2



Gustav Klauke GmbH • Auf dem Knapp 46 • D-42855 Remscheid • Telefon ++49 +2191-907-0 • Telefax ++49 +2191-907-141 • www.klauke.com

Klauke®

Wir freuen uns, dass Sie sich für ein Klauke Werkzeug entschieden haben und wünschen Ihnen viel Freude damit.

**2 Jahre
Garantie**

**Weltweiter
Werkzeug
Service
KLAUKE ASC**

Sie haben ein Qualitätsprodukt „Made in Germany“ erworben und erhalten 2 Jahre Garantie. Diese beginnt mit dem Kaufbelegdatum.

Um lange Freude und eine einwandfreie Funktion des Werkzeuges sicherzustellen, muss das Gerät spätestens beim Erreichen von 10.000 Arbeitsvorgängen oder nach 3 Jahren durch ein Autorisiertes Service Center (ASC) gewartet werden. Wird das Wartungsintervall von 10.000 Arbeitsvorgängen nicht eingehalten, erlischt der Garantieanspruch.

Im Rahmen dieser Wartung werden verschlissene Teile ersetzt und sicherheitsrelevante Teile geprüft und ggf. vorbeugend ersetzt.

Darüber hinaus empfehlen wir das Gerät jährlich zur Überprüfung an das zuständige ASC einzusenden.

Für Fragen rund um unseren Werkzeugservice oder eine Frage zu einem bestimmten Anwendungsfall stehen wir Ihnen persönlich unter der kostenlosen 0800-4685528 zur Verfügung.



Ihr Klauke Team

Thank you for choosing a Klauke tool. We hope it gives you lots of pleasure.

**2 years
Warranty**

**World wide
Tool
Service
KLAUKE ASC**

You have purchased a quality product „Made in Germany“, which is covered by a 2 year warranty. The warranty commences from the purchase receipt date.

To ensure lasting enjoyment and a flawless tool function, the product must be serviced by an Authorized Service Center (ASC) after 10,000 operations or after 3 years. Should the service Interval exceed 10.000 cycles the warranty claim is void.

The Service includes predictive maintenance in which worn-out parts will be replaced and safety relevant parts checked/replaced.

We recommend to have the tools checked yearly through an Authorized Service Center (ASC).

If you have any questions about our tool service or about a specific application, please go to <http://www.klauke.com/en/support/tool-service/>



Your Klauke team



EK 50/5CFB

Klauke®

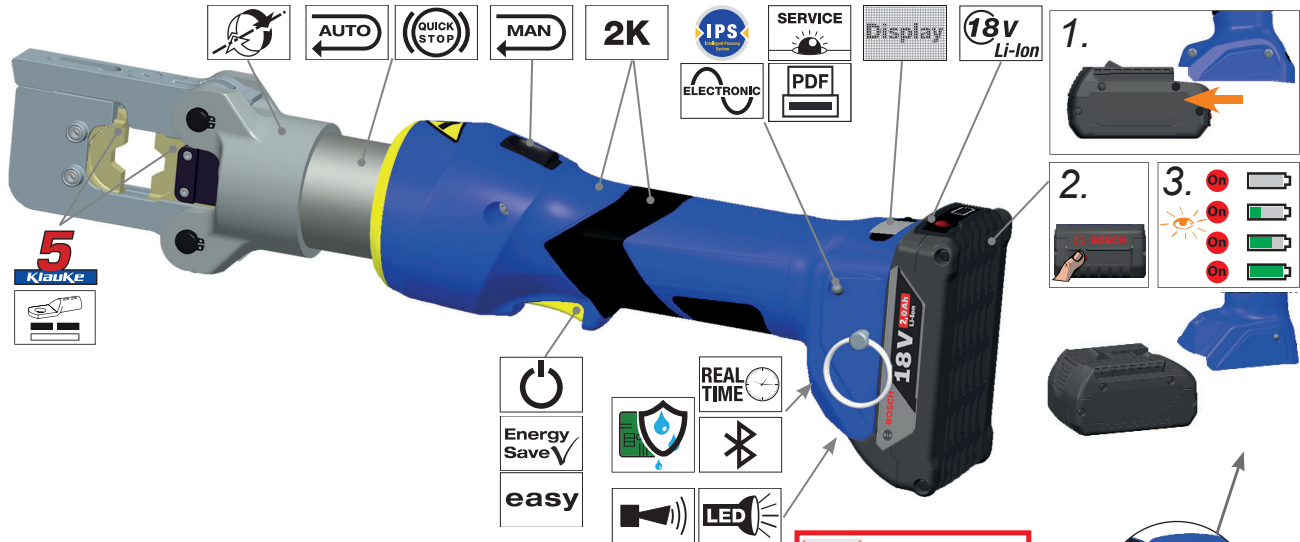

2 years Warranty

World wide Tool Service

ACHTUNG! Bei Beschädigung des Garantiesiegels ist der Garantieverlust zu erwarten. ATTENTION! Warranty seal if broken loses Warranty

datecode

| Year | Code | Month | Code | Month | Code |
|------|------|-------|------|-------|------|
| 2018 | M | Jan. | N | July | V |
| 2019 | N | Feb. | P | Aug. | W |
| 2020 | P | Mar. | Q | Sept. | X |
| 2021 | Q | Apr. | R | Oct. | Y |
| 2022 | R | May | S | Nov. | Z |
| 2023 | S | June | T | Dec. | 1 |

batch# e.g. 304711
 datecode e.g. P = 2020; R = April
 consecutive# e.g. „142“ = tool # 142

304711
PR
142

Klauke
Auf dem Knapp 46
D-42855
Remscheid

WORK SERVICE DON'T DO DON'T DO General safety rules



EK 50/5CFB

Klauke®

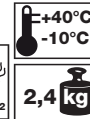
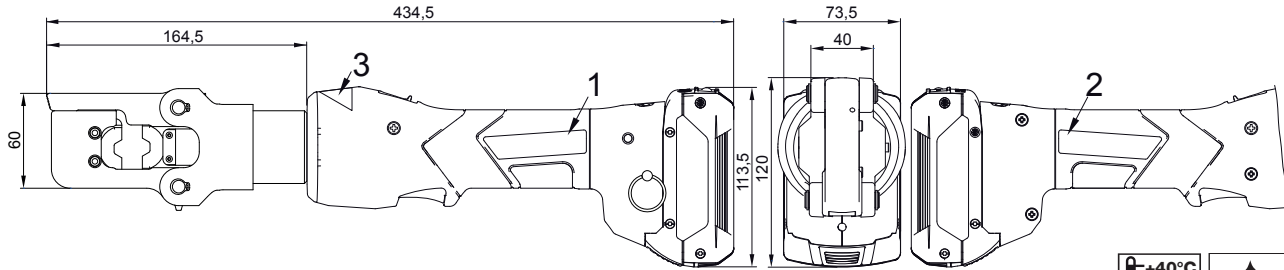

! WARNING

Read all safety warnings, instructions, illustrations and specifications provided with this power tool.

Failure to follow all instructions listed below may result in electric shock, fire and/or serious injury.

Save all warnings and instructions for future reference.





EK 50/5CFB

Klauke®

Use tool only with 18V Bosch Battery

BOSCH
 #1 609 92A 19R
 #1 609 92A 0F3

Loading Full

1.

2.

3.

| Ladegerät | GAL | | GAL 1880 CV | |
|--|--------------------------------|------|--------------------------------|------|
| Sachnummer | 2 607 225 ... 2 607 226 ... | | 2 607 225 9.. 2 607 226 0.. | |
| Akku-Ladespannung (auto-matische Spannungserkennung) V $\overline{\text{=}}$ | 14,4 – 36 | | 14,4 – 18 | |
| Ladestrom A | 8,0 | | 8,0 | |
| Zulässiger Ladetemperaturbereich °C | 0 – 45 | | 0 – 45 | |
| Ladezeit bei Akku-Kapazität, ca. | (80%) | 100% | (80%) | 100% |
| - 1,3 Ah | min (10) | 25 | (10) | 25 |
| - 1,5 Ah | min (10) | 25 | (10) | 25 |
| - 2,0 Ah RALB1__ (36Wh) | min (15) | 30 | (15) | 30 |
| - 2,6 Ah | min (15) | 30 | (15) | 30 |
| - 3,0 Ah | min (20) | 35 | (20) | 35 |
| - 4,0 Ah | min (25) | 35 | (25) | 35 |
| - 5,0 Ah RALB2__ (90Wh) | min (35) | 45 | (35) | 45 |
| - 6,0 Ah | min (35) | 50 | (35) | 50 |
| Anzahl der Akkuzellen | 4 – 30 | | 4 – 10 | |
| Gewicht entsprechend EPTA-Procedure 01:2014 | kg | 0,9 | | 0,7 |
| Schutzklasse | <input type="checkbox"/> / II | | <input type="checkbox"/> / II | |



Alle Bedienungsanleitungen auch unter www.klauke.de abrufbar
All manuals are also available on www.Klauke.com

WORK **SERVICE** **DON'T DO** **General safety rules**



EK 50/5CFB

Klauke®

⚠️ $\angle > 330^\circ$ STOP

Klauke ASC
Authorized Service Center

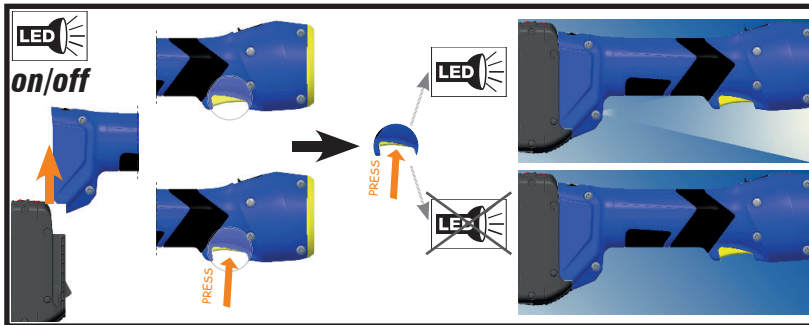
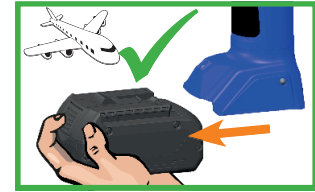
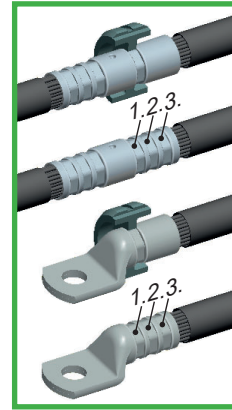
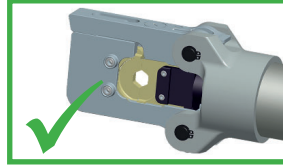
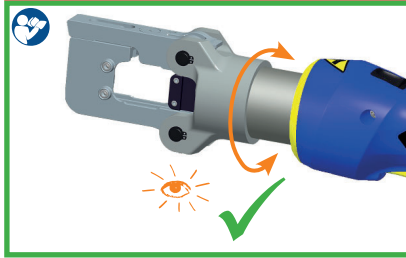



EK 50/5CFB

Klauke®

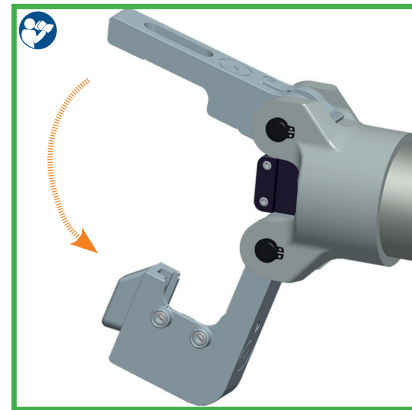
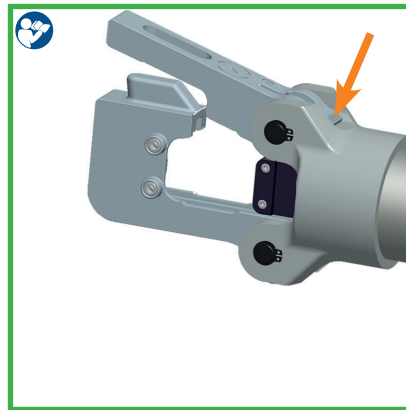
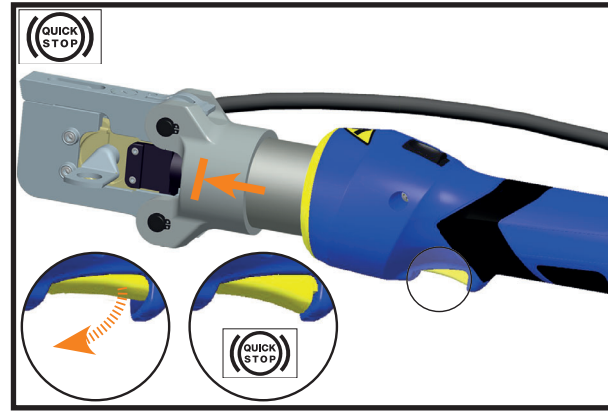
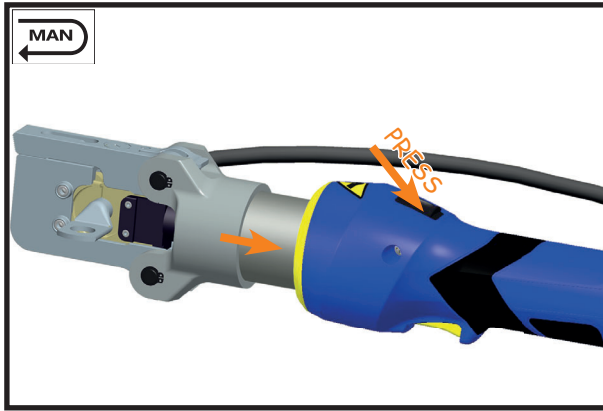



EK 50/5CFB

Klauke®

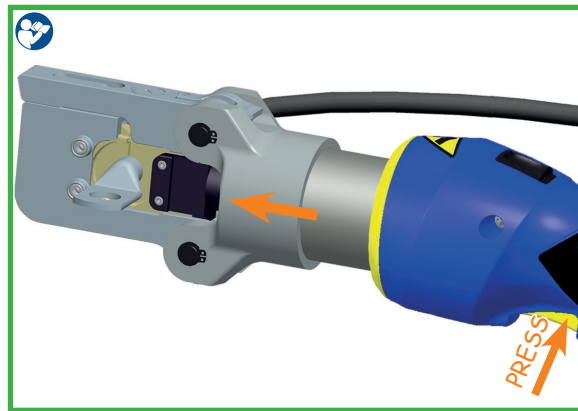
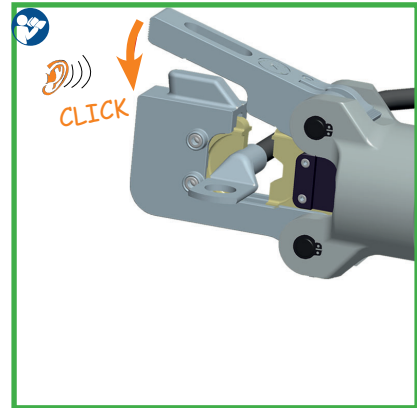
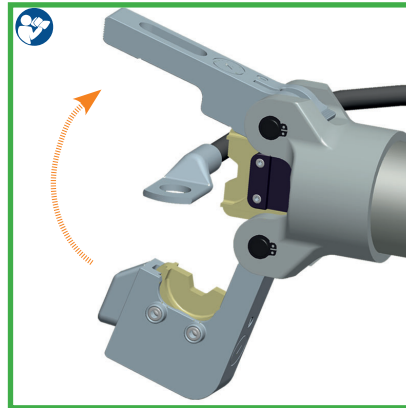
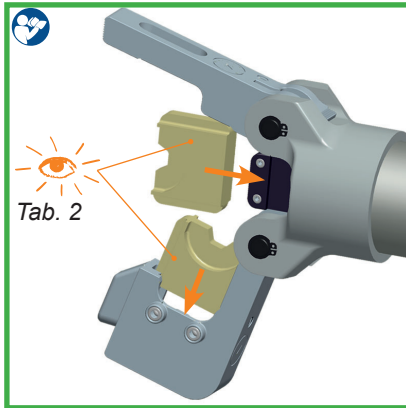



| | | |
|----|---------------------|--|
| 1 | | |
| 2 | | |
| | ERROR CODE: **** | Error code *1 |
| 3 | | Bluetooth (if connected) Battery charging level Current pressure Pressure max. *2 |
| 4a | | Doubleclick |
| 4b | | Singleclick enter menue |
| 4c | | Doubleclick select |
| 4d | | Doubleclick confirmed |
| 5 | | Cycles (until next service) |
| 6 | | Since manufacturing: operating hours Capacity # crimps |
| 7 | | |

- *1 Error codes:
- Overcurrent fuse
 - Overcurrent comparator
 - Overheat board
 - Overheat battery
 - Battery empty, operation stop
 - Faulty crimp motor in operation
 - Faulty crimp motor not in operation
 - Low battery
 - Battery empty
 - RTC battery low
 - Tool deactivated
 - Service necessary
 - RTC not found
 - BT unit not found
 - Pressure sensor not found
 - Burst pressure exceeded
 - Battery temperature too low

- Überstrom durch Überstromsicherung
- Überstrom durch Komparator
- Boardtemperatur zu hoch
- Akkutemperatur zu hoch
- Akkuspannung während der Operation zu gering
- Fehlpressung bei laufendem Motor
- Fehlpressung bei stehendem Motor
- Niedrige Akkuspannung
- Akku leer
- RTC-Batterie leer
- Werkzeug deaktiviert
- Service nötig
- RTC nicht verfügbar
- BT-Modul nicht verfügbar
- Drucksensor nicht verfügbar
- Berstdruck überschritten
- Akkutemperatur zu gering

*2 (2Hz)





Klauke i-press® Software

▶ www.klauke.com/connectivity



Klauke i-press® App

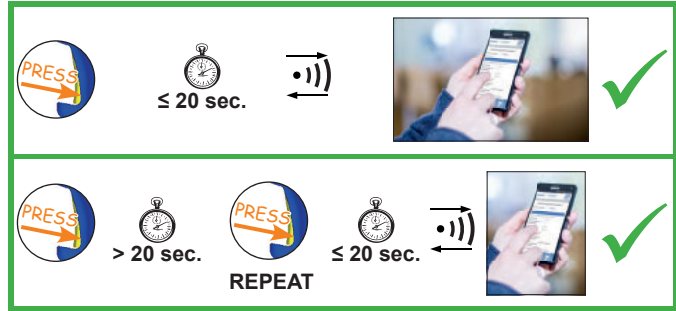



EK 50/5CFB

Klauke®

BEFORE WORK

DIN EN 50110

2 years Warranty
World wide Tool Service
KLAUKE ASC

- 1.
- 2.
- 3.

Klauke

once a year

Klauke ASC
Authorised Service Center

3 years or 10.000 operations

OLD PART REPLACEMENT SAFETY NEW

2 years Warranty
World wide Tool Service
KLAUKE ASC

Klauke ASC
Authorised Service Center

WEEE 2012/19/EU

Klauke-WEEE-Abholung@Emerson.com

Klauke ASC
Authorised Service Center

WORK

SERVICE

DON'T DO









General safety rules



| | | | Wann/When/Quand/Quando/ cuándo/Wanneer/Когда/это происходит/Kiedy/quando | Warum/Why/Pourquoi/Porquê/ ¿por qué?/Waarom/Причина/ Dlaczego/Perché |
|----------------|--|--|---|---|
| 20 sec | | | nach Arbeitsvorgang after working cycle après opération de travail Después del proceso de trabajo após o processo de trabalho na bedrijfscyclus после цикла опрессовки po zakończeniu pracy dopo il processo di lavoro | |
| 20 sec/2Hz | | | nach Arbeitsvorgang after working cycle après opération de travail Después del proceso de trabajo após o processo de trabalho na bedrijfscyclus после цикла опрессовки po zakończeniu pracy dopo il processo di lavoro | Klauke ASC® Authorized Service Center |
| 20 sec/5Hz | | | während der Übertemperatur while exceeding the temp. limit pendant surchauffe en caso de temperatura excesiva durante a temperatura excessiva tijdens te hoge temperatuur при высокой температуре внутри корпуса przy przegrzaniu superando il limite di temperatura | Werkzeug zu heiß Unit too hot outil surchauffé Herramienta demasiado caliente ferramenta demasiado quente gereedschap te heet Перегрев инструмента urządzenie za gorące Utensile troppo caldo |





| SERVICE  | LED  |  | Wann/When/Quand/Quando/ cuándo/Wanneer/Когда/это происходит/Kiedy/quando | Warum/Why/Pourquoi/Porquê/ ¿por qué?/Waarom/Причина/ Dlaczego/Perché |
|--|--|---|---|---|
|  1 x |  1 x |  | nach Arbeitsvorgang after working cycle après opération de travail Después del proceso de trabajo após o processo de trabalho na bedrijfsscyclus после цикла опрессовки po zakończeniu pracy dopo il processo di lavoro | Fehler: der notwendige Pressdruck wurde nicht erreicht. Es handelt sich um eine manuelle Unterbrechung der Pressung bei stehendem Motor. Error: the required pressure has not been reached. The operator has interrupted the pressing cycle manually while the motor was not running. ERREUR: Pression necessaire pas atteinte. Il s'agit d'une interruption manuelle de la sertissage au moteur arrêté. Error: No se ha alcanzado la presión necesaria o el operador ha interrumpido el ciclo a mano mientras el motor ha parado. Falha: a pressão de prensagem necessária não foi alcançada. Trata-se de uma interrupção manual da prensagem com o motor parado. Foutmelding: De benodigde persdruk wordt niet bereikt. De gebruiker heeft de verkrimping handmatig stopgezet aangezien de motor niet actief is. Ошибка: не было достигнуто требуемое усилие опрессовки или оператор прервал процесс опрессовки вручную, когда двигатель остановился. Błąd: konieczne ciśnienie nie zostało osiągnięte. Użytkownik przerwał cykl pracy ręcznie w chwili, gdy silnik nie był włączony Errore: la pressione richiesta non è stata raggiunta. L'operatore ha interrotto manualmente il ciclo di pressatura mentre il motore non è in funzione. |
|  3 x |  3 x |  | nach Arbeitsvorgang after working cycle après opération de travail Después del proceso de trabajo após o processo de trabalho na bedrijfsscyclus после цикла опрессовки po zakończeniu pracy dopo il processo di lavoro | Schwerwiegender Fehler: Pressdruck wurde bei laufendem Motor nicht erreicht. Serious Error: The pressure has not been reached while the motor was running. Erreur Grave: Pression pas atteinte au moteur courant. Error grave: No se ha alcanzado presión mientras el motor estaba en marcha Falha grave: a pressão de prensagem não foi alcançada com o motor em funcionamento. Urgente foutmelding: De persdruk werd bij een werkende motor niet bereikt. Серьезная ошибка: не было достигнуто требуемое усилие опрессовки во время работы двигателя Poważny błąd: konieczne ciśnienie nie zostało osiągnięte podczas pracy silnika Errore grave: la pressione non è stata raggiunta mentre il motore è in funzione. |



Tab. 2

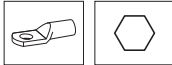
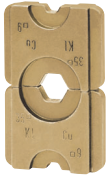

geeignet für/suitable for/approprié pour:

Rohrkabelschuhe und
Verbinder „Normalausführung“
Tubular cable lugs and connectors
„Standard type“
cosses et manchons tubulaires
„Type Standard“

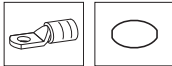

geeignet für/suitable for/approprié pour:

Isolierte Rohrkabelschuhe und Verbinder
Isolierte Stiftkabelschuhe
Insulated tubular cable lugs and connectors
Insulated pin cable lugs
cosses et manchons tubulaires isolees
cosses fiches isolees

5
Klauke

Presseinsätze/dies/matrices HR 5

| mm ² | Art.-Nr. Part No. Art. n° | Pressbreite mm Crimp width mm larg. mm |
|-----------------|---------------------------------|--|
| 6 + 35 | HR5635 | 5 |
| 10 + 50 | HR51050 | 5 |
| 16 + 70 | HR51670 | 5 |
| 25 + 95 | HR52595 | 5 |
| 120 | HR5120 | 5 |
| 150 | HR5150 | 5 |
| 185 | HR5185 | 5 |
| 240 | HR5240 | 5 |

Presseinsätze/dies/matrices HIS 5

| mm ² | Art.-Nr. Part No. Art. n° | Pressbreite mm Crimp width mm larg. mm |
|-----------------|---------------------------------|--|
| 10 | HIS510 | 5 |
| 16 | HIS516 | 5 |
| 25 | HIS525 | 5 |
| 35 | HIS535 | 5 |
| 50 | HIS550 | 5 |
| 70 | HIS570 | 5 |
| 95 | HIS595 | 5 |

**geeignet für/suitable for/approprié pour:**

Rohrkabelschuhe und Verbinder
für feindrähtige Leiter
Tubular cable lugs and connectors
for fine stranded cables
cosses et manchons tubulaires
pour DIN 60228 §5&6

Presseinsätze/dies/matrices HF 5

| mm ² | Art.-Nr. Part No. Art. n° |
|-----------------|---------------------------------|
| 10 | HF510 |
| 16 | HF516 |
| 25 | HF525 |
| 35 | HF535 |
| 50 | HF550 |

**geeignet für/suitable for/approprié pour:**

Rundrückeinsätze für 3 und 4-Adrige Al-
und Cu-Sektorleiter
Roundpressing dies for 3 and 4 stranded
Al- and Cu-sector conductors
mise au rond pour cables AL/CU a trois et
quatre conducteurs

Presseinsätze/dies/matrices HRU 5

| mm ² se | mm ² sm | Art.-Nr. Part No. Art. n° | Leiter Ø mm Conductor Ø mm conducteur | Rundrückbreite mm Pre-rounding width mm matrice de mises au rond |
|--------------------|--------------------|---------------------------------|---|--|
| | 10 | HRU510 | 4,1 | 12 |
| | 16 | HRU516 | 5,1 | 12 |
| 35 | 25 | HRU53525 | 6,3 | 12 |
| 50 | 35 | HRU55035 | 7,5 | 12 |
| 70 | 50 | HRU57050 | 9 | 12 |
| 95 | 70 | HRU59570 | 10,5 | 12 |
| 120 | 95 | HRU512095 | 12,5 | 12 |
| 150 | 120 | HRU5150120 | 14 | 12 |
| 185 | 150 | HRU5185150 | 15,7 | 12 |
| 240 | 185 | HRU5240185 | 17,5 | 12 |
| 300 | 240 | HRU5300240 | 20,3 | 12 |

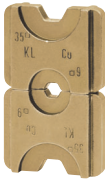
**geeignet für/suitable for/approprié pour:**Presskabelschuhe und Verbinder nach
DIN 46235 / DIN 46247Cable lugs and connectors acc. to
DIN 46235 / DIN 46247cosses et machons tubulaire selon
DIN 46235 / DIN 46247**Presseinsätze/dies/matrices HD 5**

| mm ² | Art.-Nr. Part No. Art. n° | Kennziffer Code code | Pressbreite mm Crimp width mm larg. mm |
|-----------------|---------------------------------|----------------------------|--|
| 6 + 35 | HD5635 | 5 + 12 | 5 |
| 10 + 50 | HD51050 | 6 + 14 | 5 |
| 16 + 70 | HD51670 | 8 + 16 | 5 |
| 25 + 95 | HD52595 | 10 + 18 | 5 |
| 120 | HD5120 | 20 | 5 |
| 150 | HD5150 | 22 | 5 |
| 185 | HD5185 | 25 | 5 |

Presseinsätze/dies/matrices HA 5

| mm ² | Art.-Nr. Part No. Art. n° | Kennziffer Code code | Pressbreite mm Crimp width mm larg. mm |
|-----------------|---------------------------------|----------------------------|--|
| 10 | HA510 | 10 | 7 |
| 16-25 | HA51625 | 12 | 7 |
| 35 | HA535 | 14 | 7 |
| 50 | HA550 | 16 | 7 |
| 70 | HA570 | 18 | 7 |
| 95-120 | HA595120 | 22 | 7 |
| 150 | HA5150 | 25 | 7 |

**geeignet für/suitable for/approprié pour:**

Aluminium-Kabelschuhe und Verbinder

AL-Cable lugs and connectors

AL-cosses et machons tubulaire

Presseinsätze/dies/matrices HZAE 5

| mm ² | Art.-Nr. Part No. Art. n° | Pressbreite mm Crimp width mm larg. mm |
|-----------------|---------------------------------|--|
| 2 x 4 | HZAE54 | 20 |
| 2 x 6 | HZAE56 | 20 |
| 2 x 10 | HZAE510 | 20 |
| 2 x 16 | HZAE516 | 20 |

**geeignet für/suitable for/approprié pour:**

Zwilling-Aderendhülsen

Twin wire ferrules

embouts de câblage (douilles terminales)

**geeignet für/suitable for/approprié pour:**

Quetschkabelschuhe (DIN 46234) und
Stiftkabelschuhe (DIN 46230)
Terminals DIN 46234 et DIN 46230
Cosses DIN 46234 et DIN 46230

Presseinsätze/dies/matrices HQ 5

| mm ² | Art.-Nr. Part No. Art. n° |
|-----------------|---------------------------------|
| 10 | HQ510 |
| 16 | HQ516 |
| 25 | HQ525 |
| 35 | HQ535 |
| 50 | HQ550 |

**geeignet für/suitable for/approprié pour:**

Pressverbinder für zugfeste Verbindungen von Aldrey-Seilen nach DIN EN 50182
Compression joints for full tension connectors of Aldrey conductors acc. to DIN EN 50182
Machion de jonction aeriens selon DIN EN 50182

Presseinsätze/dies/matrices HAD 5

| mm ² | Art.-Nr. Part No. Art. n° | Kennziffer Code code | Pressbreite mm Crimp width mm larg. mm |
|-----------------|---------------------------------|----------------------------|--|
| 25 | HAD525 | 12 | 7 |
| 35 | HAD535 | 14 | 7 |
| 50 | HAD550 | 16 | 7 |
| 70 | HAD570 | 18 | 7 |
| 95 | HA5D95 | 20 | 7 |

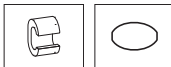
**geeignet für/suitable for/approprié pour:**

Abzweigklemmen C-Form
C-Clamps
Raccord en C

Presseinsätze/dies/matrices HC 5

| mm ² | Art.-Nr. Part No. Art. n° | Pressbreite mm Crimp width mm larg. mm |
|-----------------|---------------------------------|--|
| 16 | HC516 | 5 |
| 25 | HC525 | 5 |
| 35 | HC535 | 5 |

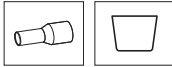
**geeignet für/suitable for/approprié pour:**

Aderendhülsen
Wire ferrules
Embouts de cablage

Presseinsätze/dies/matrices HAE 5

| mm ² | Art.-Nr. Part No. Art. n° | Pressbreite mm Crimp width mm larg. mm |
|-----------------|---------------------------------|--|
| 10 | HAE510 | 20 |
| 16 | HAE516 | 20 |
| 25 | HAE525 | 20 |
| 35 | HAE535 | 20 |
| 50 | HAE550 | 20 |

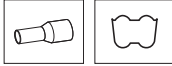
**geeignet für/suitable for/approprié pour:**

Aderendhülsen für verdichtete feindrähtige Leiter
Wire ferrules for fine stranded cables
Embouts de cablage pour cable souple compacter

Presseinsätze/dies/matrices HAES 5

| mm ² | Art.-Nr. Part No. Art. n° | Pressbreite mm Crimp width mm larg. mm |
|-----------------|---------------------------------|--|
| 10 | HAES510 | 20 |
| 16 | HAES516 | 20 |
| 25 | HAES525 | 20 |
| 35 | HAES535 | 20 |
| 50 | HAES550 | 20 |

**geeignet für/suitable for/approprié pour:**

Zwillings-Aderendhülsen für verdichtete feindrähtige Leiter
Twin Wire ferrules for fine stranded cables
Embouts de cablage (douilles terminales) pour cable souple compacter

Presseinsätze/dies/matrices HZAES 5

| mm ² | Art.-Nr. Part No. Art. n° | Pressbreite mm Crimp width mm larg. mm |
|-----------------|---------------------------------|--|
| 2 x 4 | HZAES54 | 20 |
| 2 x 6 | HZAES56 | 20 |
| 2 x 10 | HZAES510 | 20 |
| 2 x 16 | HZAES516 | 20 |

Handgeführtes batteriebetriebenes Elektrowerkzeug Typ EK505CFB

Klauke[®]

(D) CE-17 - Konformitätserklärung. Wir erklären in alleiniger Verantwortlichkeit, daß dieses Produkt mit den folgenden Normen oder normativen Dokumenten übereinstimmt: EN 62841-1, EN ISO 12100, EN ISO 13857, EN 349, EN 28662-1, EN 61000-6-3, EN 61000-6-2, EN 60529, EN 1037 gemäß den Bestimmungen der Richtlinien 2006/42/EG, 2014/30/EU, 2011/65/EU

(GB) CE-17 - Declaration of conformity. We declare under our sole responsibility that this product is in conformity with the following standards or normative documents: EN 62841-1, EN ISO 12100, EN ISO 13857, EN 349, EN 28662-1, EN 61000-6-3, EN 61000-6-2, EN 60529, EN 1037 in accordance with the regulations of directives 2006/42/EG, 2014/30/EU, 2011/65/EU

(F) CE-17 - Déclaration de conformité. Nous déclarons sous notre seule responsabilité que ce produit est en conformité avec les normes ou documents normatifs suivants: EN 62841-1, EN ISO 12100, EN ISO 13857, EN 349, EN 28662-1, EN 61000-6-3, EN 61000-6-2, EN 60529, EN 1037 conformément aux réglementations des directives 2006/42/EG, 2014/30/EU, 2011/65/EU

(E) CE-17 - Declaración de conformidad. Declaramos bajo nuestra sola responsabilidad que este producto está en conformidad con las normas o documentos normativos siguientes: EN 62841-1, EN ISO 12100, EN ISO 13857, EN 349, EN 28662-1, EN 61000-6-3, EN 61000-6-2, EN 60529, EN 1037 de acuerdo con las regulaciones de las directivas 2006/42/EG, 2014/30/EU, 2011/65/EU

(I) CE-17 - Dichiarazione di conformità. Dichiariamo sotto la nostra esclusiva responsabilità che questo prodotto è conforme alle seguenti norme e documenti normativi: EN 62841-1, EN ISO 12100, EN ISO 13857, EN 349, EN 28662-1, EN 61000-6-3, EN 61000-6-2, EN 60529, EN 1037 conformemente alle disposizioni delle direttive 2006/42/EG, 2014/30/EU, 2011/65/EU

(P) CE-17 - Declaração de conformidade. Declaramos sob nossa exclusiva responsabilidade que este produto cumpre as seguintes normas ou documentos normativos: EN 62841-1, EN ISO 12100, EN ISO 13857, EN 349, EN 28662-1, EN 61000-6-3, EN 61000-6-2, EN 60529, EN 1037 conforme as disposições das directivas 2006/42/EG, 2014/30/EU, 2011/65/EU

(NL) CE-17 - Konformiteitsverklaring. Wij verklaren en wij stellen ons er alleen voor verantwoordelijk dat dit product voldoet aan de volgende normen of normatieve documenten: EN 62841-1, EN ISO 12100, EN ISO 13857, EN 349, EN 28662-1, EN 61000-6-3, EN 61000-6-2, EN 60529, EN 1037 overeenkomstig de bepalingen van de richtlijnen 2006/42/EG, 2014/30/EU, 2011/65/EU

(GR) CE-17 - ΔΗΛΩΣΗ ΣΥΜΜΟΡΦΩΣΗΣ Με αναληψη συλλογικης δηλωνομε: οτι το πορον προιον συμφωνα με τα παρακατω ποστυπα και με τα ηρωτηα που αναφερονται στα σχετικα εγγραφα. EN 62841-1, EN ISO 12100, EN ISO 13857, EN 349, EN 28662-1, EN 61000-6-3, EN 61000-6-2, EN 60529, EN 1037 συμφωνα με τοχς κοινοισμους 2006/42/EG, 2014/30/EU, 2011/65/EU

(S) CE-17 - Konformitetsdeklaration. Vi förklarar på eget ansvar att denna produkt överensstämmer med följande normer eller normativa dokument: EN 62841-1, EN ISO 12100, EN ISO 13857, EN 349, EN 28662-1, EN 61000-6-3, EN 61000-6-2, EN 60529, EN 1037 enligt bestämmelserna i direktiverna 2006/42/EG, 2014/30/EU, 2011/65/EU

(DK) CE-17 - Konformitetserklæring. Vi erklærer under almindeligt ansvar at dette produkt er i overensstemmelse med følgende normer eller normative dokumenter: EN 62841-1, EN ISO 12100, EN ISO 13857, EN 349, EN 28662-1, EN 61000-6-3, EN 61000-6-2, EN 60529, EN 1037 i henhold til bestemmelserne i direktiverne 2006/42/EØF, 2014/30/EU, 2011/65/EU

(N) CE-17 - Konformitetserklæring. Vi erklærer på eget ansvarlighet at dette produkt er i overensstemmelse med følgende standarder eller standard-dokumenter: EN 62841-1, EN ISO 12100, EN ISO 13857, EN 349, EN 28662-1, EN 61000-6-3, EN 61000-6-2, EN 60529, EN 1037 i henhold til bestemmelserne i direktive ne 2006/42/EØF, 2014/30/EU, 2011/65/EU

(FIN) CE-17 - Todistus standardinmukaissuudesta. Asiaasta vastaavana todistamme täten, että tämä tuote on seuraavien standardien ja standardoimisasiakirjojen vaatimusten mukainen: EN 62841-1, EN ISO 12100, EN ISO 13857, EN 349, EN 28662-1, EN 61000-6-3, EN 61000-6-2, EN 60529, EN 1037 ja vastaa säädöksiä 2006/42/EG, 2014/30/EU, 2011/65/EU

(SK) CE-17 - Prehlásenie o zhode. Prehlasujeme na vlastnú zodpovednosť, že tieto produkty sú v súlade s nasledovnými normami: EN 62841-1, EN ISO 12100, EN ISO 13857, EN 349, EN 28662-1, EN 61000-6-3, EN 61000-6-2, EN 60529, EN 1037 a v zhode so smernicami 2006/42/EG, 2014/30/EU, 2011/65/EU

(PL) CE-17 - Zgodność z dyrektywami CE. Świadomy odpowiedzialności oświadczamy, że niniejszy produkt jest zgodny z następującymi normami lub dokumentacją normatywną: EN 62841-1, EN ISO 12100, EN ISO 13857, EN 349, EN 28662-1, EN 61000-6-3, EN 61000-6-2, EN 60529, EN 1037 zgodnie z postanowieniami wytycznych 2006/42/EG, 2014/30/EU, 2011/65/EU

(CZ) CE-17 - Prohlášení o shode. Prohlasujeme na vlastní zodpovednosť, že tyto produkty splňují následující normy nebo normativní listiny: EN 62841-1, EN ISO 12100, EN ISO 13857, EN 349, EN 28662-1, EN 61000-6-3, EN 61000-6-2, EN 60529, EN 1037; Ve shode se smernicami 2006/42/EG, 2014/30/EU, 2011/65/EU

(SLO) CE-17 - Izjava o skladnosti. S tem potrjujemo splošno odgovornost, da je ta izdelek narejen v skladu z navedenimi normami in standardi: EN 62841-1, EN ISO 12100, EN ISO 13857, EN 349, EN 28662-1, EN 61000-6-3, EN 61000-6-2, EN 60529, EN 1037 ter določbami in smernicami 2006/42/EG, 2014/30/EU, 2011/65/EU

(HR) CE-17 - Izjava o skladnosti. Pod punom odgovornošću izjavljujemo da je proizvod naveden u naslovu ovog dokumenta sukladan sa primijenjenim normama i normativnim dokumentima: EN 62841-1, EN ISO 12100, EN ISO 13857, EN 349, EN 28662-1, EN 61000-6-3, EN 61000-6-2, EN 60529, EN 1037 u skladu sa odredbama preporuka 2006/42/EG, 2014/30/EU, 2011/65/EU

(H) CE-17 - Megfelelősségi nyilatkozat. Kéziműködtetésű elektromos kéziszerszámok: Teljes felelősséggel kijelentjük, hogy ezek a termékek a következő szabványokkal és irányelvekkel összhangban vannak: EN 62841-1, EN ISO 12100, EN ISO 13857, EN 349, EN 28662-1, EN 61000-6-3, EN 61000-6-2, EN 60529, EN 1037; és megfelelnek a rendeltetés szerinti 2006/42/EG, 2014/30/EU, 2011/65/EU irányelveknek.

(RO) CE-17 - Declarație de conformitate. Noi declarăm pe propria răspundere că acest produs este în conformitate cu următoarele norme și documente normative: EN 62841-1, EN ISO 12100, EN ISO 13857, EN 349, EN 28662-1, EN 61000-6-3, EN 61000-6-2, EN 60529, EN 1037; potrivit dispozițiilor directivei 2006/42/EG, 2014/30/EU, 2011/65/EU

Remscheid, den 02.11.2017



Joh. - Christoph Schütz

Dipl.-Ing. Joh.-Christoph Schütz, CE-Beauftragter

- (D) CE-17 - Konformitätserklärung RED. Wir erklären in alleiniger Verantwortlichkeit, daß dieses Produkt mit den folgenden Normen oder normativen Dokumenten übereinstimmt: EN 60950-1, EN 301489-1, EN 301489-17, EN 300328 V2.1.1, EN 62479 gemäß den Bestimmungen der Richtlinien 2014/53/EU, 2011/65/EU
- (GB) CE-17 - Declaration of conformity RED. We declare under our sole responsibility that this product is in conformity with the following standards or normative documents: EN 60950-1, EN 301489-1, EN 301489-17, EN 300328 V2.1.1, EN 62479 in accordance with the regulations of directives 2014/53/EU, 2011/65/EU
- (F) CE-17 - Déclaration de conformité RED. Nous déclarons sous notre seule responsabilité que ce produit est en conformité avec les normes ou documents normatifs suivants: EN 60950-1, EN 301489-1, EN 301489-17, EN 300328 V2.1.1, EN 62479 conformément aux réglementations des directives 2014/53/EU, 2011/65/EU
- (E) CE-17 - Declaración de conformidad RED. Declaramos bajo nuestra sola responsabilidad que este producto está en conformidad con las normas o documentos normativos siguientes: EN 60950-1, EN 301489-1, EN 301489-17, EN 300328 V2.1.1, EN 62479 de acuerdo con las regulaciones de las directivas 2014/53/EU, 2011/65/EU
- (I) CE-17 - Dichiarazione di conformità RED. Dichiariamo sotto la nostra esclusiva responsabilità che questo prodotto è conforme alle seguenti norme e documenti normativi: EN 60950-1, EN 301489-1, EN 301489-17, EN 300328 V2.1.1, EN 62479 conformemente alle disposizioni delle direttive 2014/53/EU, 2011/65/EU
- (P) CE-17 - Declaração de conformidade RED. Declaramos sob nossa exclusiva responsabilidade que este produto cumpre as seguintes normas ou documentos normativos: EN 60950-1, EN 301489-1, EN 301489-17, EN 300328 V2.1.1, EN 62479 conforme as disposições das directivas 2014/53/EU, 2011/65/EU
- (NL) CE-17 - Konformiteitsverklaring RED. Wij verklaren en wij stellen ons er alleen voor verantwoordelijk dat dit produkt voldoet aan de volgende normen of normatieve documenten: EN 60950-1, EN 301489-1, EN 301489-17, EN 300328 V2.1.1, EN 62479 overeenkomstig de bepalingen van de richtlijnen 2014/53/EU, 2011/65/EU
- (GR) CE-17 - ΔΗΛΩΣΗ ΣΥΜΜΟΡΦΩΣΗΣ Μ RED. Η αναλήψη συνολικής δηλώνουμε: ότι το πορον προϊόν συμφώνει με τα παρακάτω ποσούνα και με τα ηροτινη ήου αναφερονται στα σχετικό εγγραφα: EN 60950-1, EN 301489-1, EN 301489-17, EN 300328 V2.1.1, EN 62479 σύμφωνα με τοχ κοινούμοιος 2014/53/EU, 2011/65/EU
- (S) CE-17 - Konformitetsdeklaration RED. Vi förklarar på eget ansvar att denna produkt överensstämmer med följande normer eller normativa dokument: EN 60950-1, EN 301489-1, EN 301489-17, EN 300328 V2.1.1, EN 62479 enligt bestämmelserna i direktiverna 2014/53/EU, 2011/65/EU
- (DK) CE-17 - Konformitetserklæring RED. Vi erklærer under almindeligt ansvar at dette produkt er i overensstemmelse med følgende normer eller normative dokumenter: EN 60950-1, EN 301489-1, EN 301489-17, EN 300328 V2.1.1, EN 62479 i henhold til bestemmelserne i direktivene 2014/53/EU, 2011/65/EU
- (N) CE-17 - Konformitetserklæring RED. Vi erklærer på eget ansvarlighet at dette produkt er i overensstemmelse med følgende standarder eller standard-dokumenter: EN 60950-1, EN 301489-1, EN 301489-17, EN 300328 V2.1.1, EN 62479 i henhold til bestemmelserne i direktive ne 2014/53/EU, 2011/65/EU
- (FIN) CE-17 - Todistus slandardinmukaisuudesta RED. Asiasta vastaavana todistamme läten, että tämä tuote on seuraavien standardien ja standardoimisasiakirjojen vaatimusten mukainen: EN 60950-1, EN 301489-1, EN 301489-17, EN 300328 V2.1.1, EN 62479 ja vastaa säädöksiä 2014/53/EU, 2011/65/EU
- (SK) CE-17 - Prehlásenie o zhode RED. Prehlasujeme na vlastnú zodpovednosť, že tieto produkty sú v súlade s nasledovnými normami: EN 60950-1, EN 301489-1, EN 301489-17, EN 300328 V2.1.1, EN 62479 a v zhode so smernicami 2014/53/EU, 2011/65/EU
- (PL) CE-17 - Zgodność z dyrektywami RED. Świadomi odpowiedzialności oświadczamy, że niniejszy produkt jest zgodny z następującymi normami lub dokumentacja normatywna: EN 60950-1, EN 301489-1, EN 301489-17, EN 300328 V2.1.1, EN 62479 zgodnie z postanowieniami wytycznych 2014/53/EU, 2011/65/EU
- (CZ) CE-17 - Prohlášení o shode RED. Prohlasujeme na vlastní zodpovednosť, že tyto produkty splňují následující normy nebo normativní listiny: EN 60950-1, EN 301489-1, EN 301489-17, EN 300328 V2.1.1, EN 62479 Ve shode se smernicami 2014/53/EU, 2011/65/EU
- (SLO) CE-17 - Izjava o skladnosti RED. S tem potrjujemo splošno odgovornost, da je ta izdelek narejen v skladu z navedenimi normami in standardi EN 60950-1, EN 301489-1, EN 301489-17, EN 300328 V2.1.1, EN 62479 ter določbami in smernicami 2014/53/EU, 2011/65/EU
- (HR) CE-17 - Izjava o skladnosti RED. Pod punom odgovornošću izjavljujemo da je proizvod naveden u naslovu ovog dokumenta skladan sa primijenjenim normama i normativnim dokumentima: EN 60950-1, EN 301489-1, EN 301489-17, EN 300328 V2.1.1, EN 62479 u skladu sa odredbama preporuka 2014/53/EU, 2011/65/EU
- (H) CE-17 - Megfelelőségi nyilatkozat RED. Kéziműködtetésű elektromos kéziszerszámok. Teljes felelősséggel kijelentjük, hogy ezek a termékek a következő szabványokkal és irányelvekkel összhangban vannak: EN 60950-1, EN 301489-1, EN 301489-17, EN 300328 V2.1.1, EN 62479 és megfelelnek a rendeltetés 2014/53/EU, 2011/65/EU irányelveknek.
- (RO) CE-17 - Declarație de conformitate RED. Noi declarăm pe propria răspundere că acest produs este în conformitate cu următoarele norme și documente normative: EN 60950-1, EN 301489-1, EN 301489-17, EN 300328 V2.1.1, EN 62479 potrivit dispozițiilor directivei 2014/53/EU, 2011/65/EU

CE

Joh. - Christoph Schütz

Dipl.-Ing. Joh.-Christoph Schütz, CE-Beauftragter

Remscheid, den 01.11.2019