



[www.klauke.com](http://www.klauke.com)

# ES 85CFB



Serialnumber



HE.17193\_E © 05/2016 R&D-2

Gustav Klauke GmbH • Auf dem Knapp 46 • D-42855 Remscheid • Telefon ++49 +2191-907-0 • Telefax ++49 +2191-907-141 • [www.klauke.com](http://www.klauke.com)

**Klauke**®





ES 85CFB

Klauke®

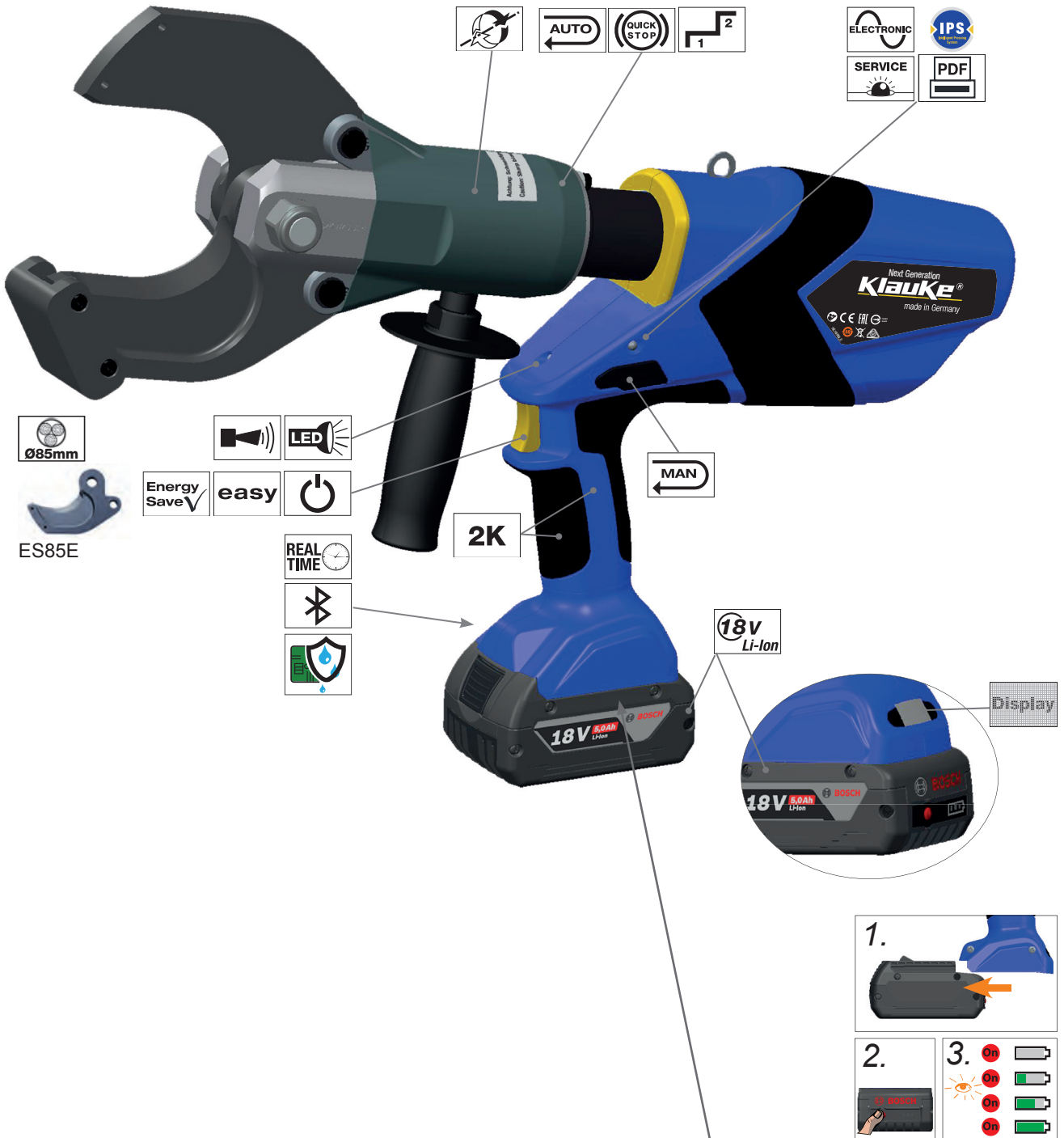

**! WARNING**

Read all safety warnings, instructions, illustrations and specifications provided with this power tool. Failure to follow all instructions listed below may result in electric shock, fire and/or serious injury.

Save all warnings and instructions for future reference.

datecode

Year	Code	Month	Code	Month	Code
2018	M	Jan.	N	July	V
2019	N	Feb.	P	Aug.	W
2020	P	Mar.	Q	Sept.	X
2021	Q	Apr.	R	Oct.	Y
2022	R	May	S	Nov.	Z
2023	S	June	T	Dec.	1

batch# e.g. 304711  
 datecode e.g. P = 2020; R = April  
 consecutive# e.g. „142“ = tool # 142



304711  
 PR  
 142

**Klauke**  
 Auf dem Klapp 46  
 D-42855  
 Remscheid

**2 years Warranty**  
 World wide Tool Service

**ACHTUNG!** Garantesiegel  
 Bei Beschädigung Garantieverlust  
**ATTENTION!** Warranty seal  
 if broken loss of Warranty



ES 85CFB

Klauke®

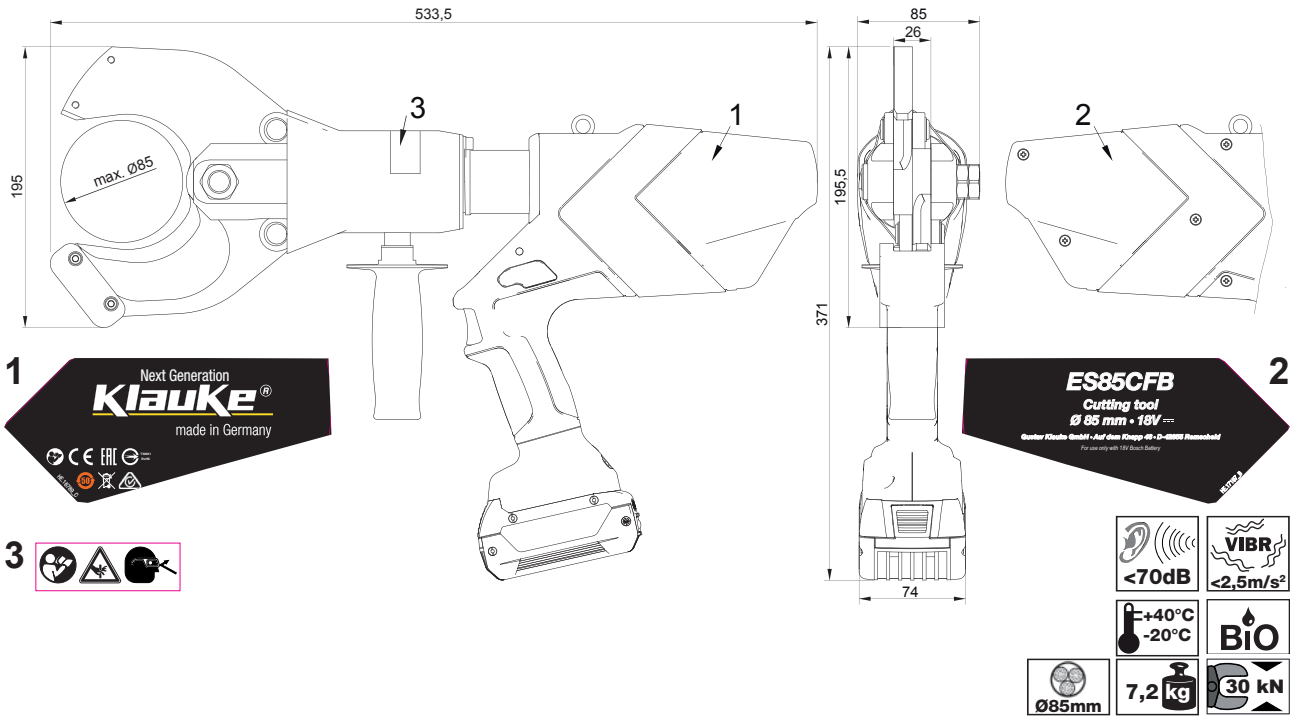

Use tool only with 18V Bosch Battery

**BOSCH**  
#1 609 92A 19R  
#1 609 92A 0F3

Li-ion

Loading Full

18V 5,0Ah Li-Ion

Ladegerät	GAL	GAL 1880 CV	
Sachnummer	2 607 225 ... 2 607 226 ...	2 607 225 9.. 2 607 226 0..	
Akku-Ladespannung (automatische Spannungserkennung) V <sub>DC</sub>	14,4–36	14,4–18	
Ladestrom A	8,0	8,0	
Zulässiger Ladetemperaturbereich °C	0–45	0–45	
Ladezeit bei Akku-Kapazität, ca.	(80%) 100%	(80%) 100%	(80%) 100%
- 1,3 Ah	min (10)	25 (10)	25 (10)
- 1,5 Ah	min (10)	25 (10)	25 (10)
- 2,0 Ah RALB1__ (36Wh)	min (15)	30 (15)	30 (15)
- 2,6 Ah	min (15)	30 (15)	30 (15)
- 3,0 Ah	min (20)	35 (20)	35 (20)
- 4,0 Ah	min (25)	35 (25)	35 (25)
- 5,0 Ah RALB2__ (90Wh)	min (35)	45 (35)	45 (35)
- 6,0 Ah	min (35)	50 (35)	50 (35)
Anzahl der Akkuzellen	4–30	4–10	
Gewicht entsprechend EPTA-Procedure 01:2014	kg 0,9	kg 0,7	
Schutzklasse	□ / II	□ / II	

1.

2.

3.

Alle Bedienungsanleitungen auch unter [www.klauke.de](http://www.klauke.de) abrufbar  
All manuals are also available on [www.Klauke.com](http://www.Klauke.com)



$> 350^\circ$

**Klauke ASC**  
Authorised Service Center

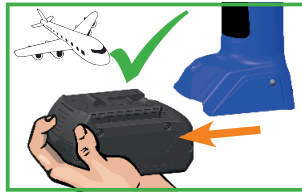

30% max.

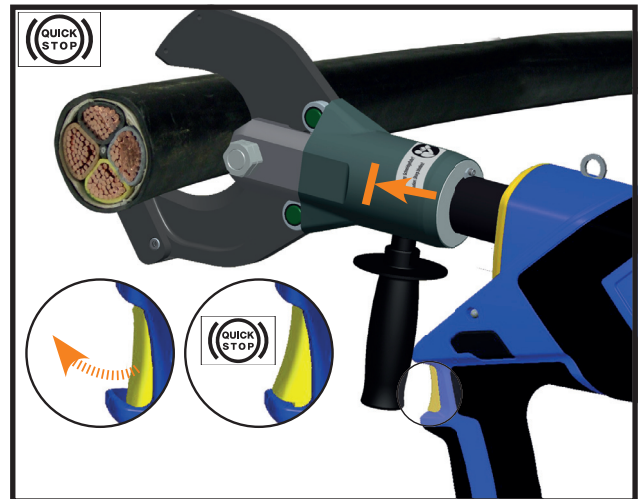
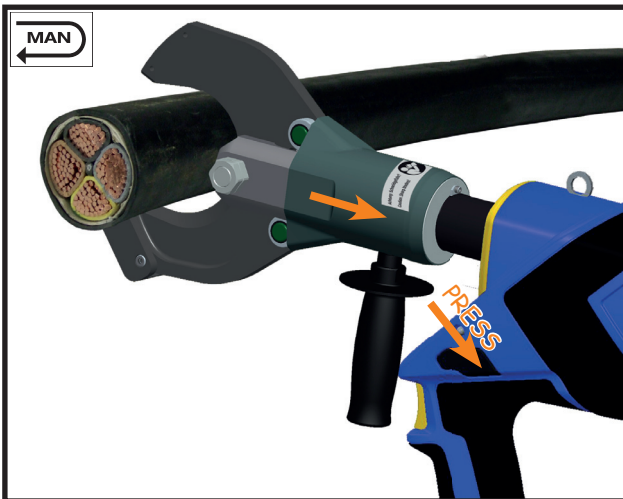

on/off

IEC 60228

CL1,2&(5)

Ø85mm

**Bestimmungsgemäße Verwendung**  
Intended use







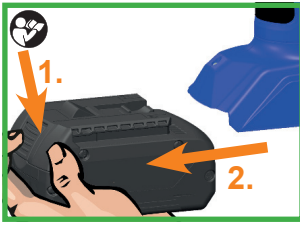

 Eindrähtiger Rundleiter cable CL1 - re	 Mehrdrähtiger Rundleiter cable CL2 - rm		
 Freileitung (Aldrey) conductor CL2 - rm	 Verdichtet Mehrdrähtig cable CL2 - rmV compacted	 Armierter Leiter, blecharmiert reinforced conductor, mild steel 1* weicher Stahl mild steel	



**Vorhersehbare Fehlanwendung**  
Foreseeable misuse

 Feinstdrähtig cable CL6 - F	 ACSR	 Armierter Leiter reinforced conductor	





1			
2		<b>Klauke®</b>	
		ERROR CODE: ****	Error code *1
3		BT  P 3 bar P 3 bar	Bluetooth (if connected) Battery charging level Current pressure Pressure max. *2
4a		USER 3: RDE Doppelklick	Doppelklick
4b	 3 sec.	USER SELECT 3: RDE Einfachklick	Singleclick enter menu
4c		USER SELECT: RDE Doppelklick	Doppelklick select
4d		USER SELECT: RDE Doppelklick	Doppelklick confirmed

5		NEXT SERVICE: 9826 0Ps	Cycles (until next service)
6		TOTAL: t = 0.07 h Q = 21.12 Ah n = 174	Since manufacturing: operating hours Capacity # crimps
7		<b>RETURN</b>	

- \*1 Error codes:
- 1 Overcurrent fuse
  - 2 Overcurrent comparator
  - 3 Overheat board
  - 4 Overheat battery
  - 5 Battery empty, operation stop
  - 6 Faulty crimp motor in operation
  - 7 Faulty crimp motor not in operation
  - 8 Low battery
  - 9 Battery empty
  - 10 RTC battery low
  - 11 Tool deactivated
  - 12 Service necessary
  - 13 RTC not found
  - 14 BT unit not found
  - 16 Pressure sensor not found
  - 17 Burst pressure exceeded
  - 18 Battery temperature too low
- 
- 1 Überstrom durch Überstromsicherung
  - 2 Überstrom durch Komparator
  - 3 Boardtemperatur zu hoch
  - 4 Akkutemperatur zu hoch
  - 5 Akkuspannung während der Operation zu gering
  - 6 Fehlpressung bei laufendem Motor
  - 7 Fehlpressung bei stehendem Motor
  - 8 Niedrige Akkuspannung
  - 9 Akku leer
  - 10 RTC-Batterie leer
  - 11 Werkzeug deaktiviert
  - 12 Service nötig
  - 13 RTC nicht verfügbar
  - 14 BT-Modul nicht verfügbar
  - 16 Drucksensor nicht verfügbar
  - 17 Berstdruck überschritten
  - 18 Akkutemperatur zu gering

\*2   (2Hz)



**Klauke i-press® Software**  
▶ [www.klauke.com/connectivity](http://www.klauke.com/connectivity)



**Klauke i-press® App**

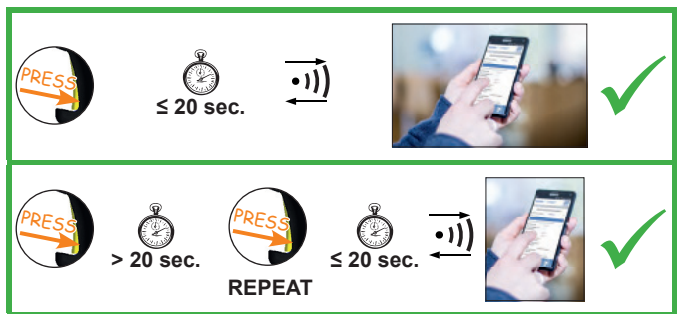
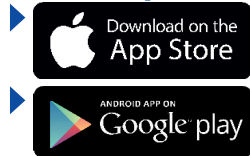



**BEFORE WORK**

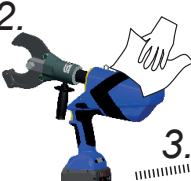

DIN EN 50110

2 years Warranty  
World wide Tool Service

- 
- 
- 

**Klauke**



once a year



**Klauke ASC**  
Authorised Service Center

3 years or 10.000 operations



**Klauke ASC**  
Authorised Service Center











WEEE 2012/19/EU

[klauke-weee-abholung@emerson.com](mailto:klauke-weee-abholung@emerson.com)

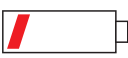

**Klauke ASC**  
Authorised Service Center

			Wann/When/Quand/Quando/ cuándo/Wanneer/Когда/это происходит/Kiedy/quando	Warum/Why/Pourquoi/Porqué/ ¿por qué?/Waarom/Причина/ Dlaczego/Perché
 20 sec			nach Arbeitsvorgang after working cycle après opération de travail Después del proceso de trabajo após o processo de trabalho na bedrijfsscyclus после цикла опрессовки po zakończeniu pracy dopo il processo di lavoro	
 20 sec/2Hz			nach Arbeitsvorgang after working cycle après opération de travail Después del proceso de trabajo após o processo de trabalho na bedrijfsscyclus после цикла опрессовки po zakończeniu pracy dopo il processo di lavoro	 <b>Klauke ASC</b> Authorised Service Center
 20 sec/5Hz			während der Übertemperatur while exceeding the temp. limit pendant surchauffe en caso de temperatura excesiva durante a temperatura excessiva tijdens te hoge temperatuur при высокой температуре внутри корпуса przy przegrzaniu superando il limite di temperatura	Werkzeug zu heiß Unit too hot outil surchauffé Herramienta demasiado caliente ferramenta demasiado quente gereedschap te heet Перегрев инструмента urządzenie za gorące Utensile troppo caldo

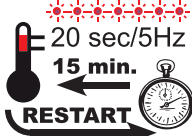

20 sec/5Hz  
15 min.  
RESTART

## Handgeführtes Elektrowerkzeug Typ ES 85CFB

**(D)** CE-17 - Konformitätserklärung. Wir erklären in alleiniger Verantwortlichkeit, daß dieses Produkt mit den folgenden Normen oder normativen Dokumenten übereinstimmt:

EN 62841-1, EN ISO 12100, EN ISO 13857, EN 349, EN 28662-1, EN 61000-6-3, EN 61000-6-2, EN 60529, EN 1037 gemäß den Bestimmungen der Richtlinien 2006/42/EG, 2014/30/EU, 2011/65/EU

**(GB)** CE-17 - Declaration of conformity. We declare under our sole responsibility that this product is in conformity with the following standards or normative documents:

EN 62841-1, EN ISO 12100, EN ISO 13857, EN 349, EN 28662-1, EN 61000-6-3, EN 61000-6-2, EN 60529, EN 1037 in accordance with the regulations of directives 2006/42/EG, 2014/30/EU, 2011/65/EU

**(F)** CE-17 - Déclaration de conformité. Nous déclarons sous notre seule responsabilité que ce produit est en conformité avec les normes ou documents normatifs suivants:

EN 62841-1, EN ISO 12100, EN ISO 13857, EN 349, EN 28662-1, EN 61000-6-3, EN 61000-6-2, EN 60529, EN 1037 conformément aux réglementations des directives 2006/42/EG, 2014/30/EU, 2011/65/EU

**(E)** CE-17 - Declaración de conformidad. Declaramos bajo nuestra sola responsabilidad que este producto está en conformidad con las normas o documentos normativos siguientes:

EN 62841-1, EN ISO 12100, EN ISO 13857, EN 349, EN 28662-1, EN 61000-6-3, EN 61000-6-2, EN 60529, EN 1037 de acuerdo con las regulaciones de las directivas 2006/42/EG, 2014/30/EU, 2011/65/EU

**(I)** CE-17 - Dichiarazione di conformità. Dichiariamo sotto la nostra esclusiva responsabilità che questo prodotto è conforme alle seguenti norme e documenti normativi:

EN 62841-1, EN ISO 12100, EN ISO 13857, EN 349, EN 28662-1, EN 61000-6-3, EN 61000-6-2, EN 60529, EN 1037 conformemente alle disposizioni delle direttive 2006/42/EG, 2014/30/EU, 2011/65/EU

**(P)** CE-17 - Declaração de conformidade. Declaramos sob nossa exclusiva responsabilidade que este produto cumpre as seguintes normas ou documentos normativos:

EN 62841-1, EN ISO 12100, EN ISO 13857, EN 349, EN 28662-1, EN 61000-6-3, EN 61000-6-2, EN 60529, EN 1037 conforme as disposições das directivas 2006/42/EG, 2014/30/EU, 2011/65/EU

**(NL)** CE-17 - Konformiteitsverklaring. Wij verklaren en wij stellen ons er alleen voor verantwoordelijk dat dit product voldoet aan de volgende normen of normatieve documenten:

EN 62841-1, EN ISO 12100, EN ISO 13857, EN 349, EN 28662-1, EN 61000-6-3, EN 61000-6-2, EN 60529, EN 1037 overeenkomstig de bepalingen van de richtlijnen 2006/42/EG, 2014/30/EU, 2011/65/EU

**(GR)** CE-17 - ΔΗΛΩΣΗ ΣΥΜΜΟΡΦΩΣΗΣ Μ. ε αναλήψη συνολικής δηλωόμε: ότι το πορον προιον συμφωνει με τα παρακατω ποστυπα και με τα ηροτυπα ηου αναφερονται στα σχετικο εγγραφα

EN 62841-1, EN ISO 12100, EN ISO 13857, EN 349, EN 28662-1, EN 61000-6-3, EN 61000-6-2, EN 60529, EN 1037 σύμφωνα με τους κωνονισμους 2006/42/EG, 2014/30/EU, 2011/65/EU

**(S)** CE-17 - Konformitetsdeklaration. Vi förklarar på eget ansvar att denna produkt överensstämmer med följande normer eller normativa dokument:

EN 62841-1, EN ISO 12100, EN ISO 13857, EN 349, EN 28662-1, EN 61000-6-3, EN 61000-6-2, EN 60529, EN 1037 enligt bestämmelserna i direktiverna 2006/42/EG, 2014/30/EU, 2011/65/EU

**(DK)** CE-17 - Konformitetserklæring. Vi erklærer under almindeligt ansvar at dette produkt er i overensstemmelse med følgende normer eller normative dokumenter:

EN 62841-1, EN ISO 12100, EN ISO 13857, EN 349, EN 28662-1, EN 61000-6-3, EN 61000-6-2, EN 60529, EN 1037 i henhold til bestemmelse i direktiverne 2006/42/EØF, 2014/30/EU, 2011/65/EU

**(N)** CE-17 - Konformitetserklæring. Vi erklærer på eget ansvarlighet at dette produkt er i overensstemmelse med følgende standarder eller standard-dokumenter:

EN 62841-1, EN ISO 12100, EN ISO 13857, EN 349, EN 28662-1, EN 61000-6-3, EN 61000-6-2, EN 60529, EN 1037 i henhold til bestemmelse i direktive ne 2006/42/EØF, 2014/30/EU, 2011/65/EU

**(FIN)** CE-17 - Todistus standardinmukaisuudesta. Asiasta vastaavana todistamme täten, että tämä tuote on seuraavien standardien ja standardoimisasiakirjojen vaatimusten mukainen:

EN 62841-1, EN ISO 12100, EN ISO 13857, EN 349, EN 28662-1, EN 61000-6-3, EN 61000-6-2, EN 60529, EN 1037 ja vastaa säädöksiä 2006/42/EG, 2014/30/EU, 2011/65/EU

**(SK)** CE-17 - Prehlásenie o zhode. Prehlasujeme na vlastnú zodpovednosť, že tieto produkty sú v súlade s nasledovnými normami: EN 62841-1, EN ISO 12100, EN ISO 13857, EN 349, EN 28662-1, EN 61000-6-3, EN 61000-6-2, EN 60529, EN 1037 a v zhode so smernicami 2006/42/EG, 2014/30/EU, 2011/65/EU

**(PL)** CE-17 - Zgodność z dyrektywami CE. Świadomi odpowiedzialności oświadczamy, że niniejszy produkt jest zgodny z następującymi normami lub dokumentacją normatywna:

EN 62841-1, EN ISO 12100, EN ISO 13857, EN 349, EN 28662-1, EN 61000-6-3, EN 61000-6-2, EN 60529, EN 1037 zgodnie z postanowieniami wytycznych 2006/42/EG, 2014/30/EU, 2011/65/EU

**(CZ)** CE-17 - Prohlášení o shode. Prohlašujeme na vlastní zodpovednost, že tyto produkty splňují následující normy nebo normativní listiny:

EN 62841-1, EN ISO 12100, EN ISO 13857, EN 349, EN 28662-1, EN 61000-6-3, EN 61000-6-2, EN 60529, EN 1037; Ve shode se směrnicemi 2006/42/EG, 2014/30/EU, 2011/65/EU

**(SLO)** CE-17 - Izjava o skladnosti. S tem potrjujemo splošno odgovornost, da je ta izdelek narejen v skladu z navedenimi normami in standardi: EN 62841-1, EN ISO 12100, EN ISO 13857, EN 349, EN 28662-1, EN 61000-6-3, EN 61000-6-2, EN 60529, EN 1037 ter določbami in smernicami 2006/42/EG, 2014/30/EU, 2011/65/EU

**(HR)** CE-17 - Izjava o skladnosti. Pod punom odgovornošću izjavljujemo da je proizvod naveden u naslovu ovog dokumenta sukladan sa primijenjenim normama i normativnim dokumentima:

EN 62841-1, EN ISO 12100, EN ISO 13857, EN 349, EN 28662-1, EN 61000-6-3, EN 61000-6-2, EN 60529, EN 1037 u skladu sa odredbama preporuka 2006/42/EG, 2014/30/EU, 2011/65/EU

**(H)** CE-17 - Megfelelőségi nyilatkozat. Kéziműködtetésű elektromos kéziszerszámok: Teljes felelősséggel kijelentjük, hogy ezek a termékek a következő szabványokkal és irányelvekkel összhangban vannak:

EN 62841-1, EN ISO 12100, EN ISO 13857, EN 349, EN 28662-1, EN 61000-6-3, EN 61000-6-2, EN 60529, EN 1037; és megfelelnek a rendeltetés szerinti 2006/42/EG, 2014/30/EU, 2011/65/EU irányelveknek.

**(RO)** CE-17 - Declarație de conformitate. Noi declarăm pe propria răspundere că acest produs este în conformitate cu următoarele norme și documente normative:

EN 62841-1, EN ISO 12100, EN ISO 13857, EN 349, EN 28662-1, EN 61000-6-3, EN 61000-6-2, EN 60529, EN 1037; potrivit dispozițiilor directivei 2006/42/EG, 2014/30/EU, 2011/65/EU

Remscheid, den 02.11.2017



Joh. - Christoph Schütz

Dipl.-Ing. Joh.-Christoph Schütz, CE-Beauftragter

## Handgeführtes Elektrowerkzeug Typ ES 85CFB

**(D)** CE-17 - Konformitätserklärung **RED**. Wir erklären in alleiniger Verantwortlichkeit, daß dieses Produkt mit den folgenden Normen oder normativen Dokumenten übereinstimmt:

EN 60950-1, EN 301489-1, EN 301489-17, EN 300328 V2.1.1, EN 62479 gemäß den Bestimmungen der Richtlinien 2014/53/EU, 2011/65/EU

**(GB)** CE-17 - Declaration of conformity **RED**. We declare under our sole responsibility that this product is in conformity with the following standards or normative documents:

EN 60950-1, EN 301489-1, EN 301489-17, EN 300328 V2.1.1, EN 62479 in accordance with the regulations of directives 2014/53/EU, 2011/65/EU

**(F)** CE-17 - Déclaration de conformité **RED**. Nous déclarons sous notre seule responsabilité que ce produit est en conformité avec les normes ou documents normatifs suivants:

EN 60950-1, EN 301489-1, EN 301489-17, EN 300328 V2.1.1, EN 62479 conformément aux réglementations des directives 2014/53/EU, 2011/65/EU

**(E)** CE-17 - Declaración de conformidad **RED**. Declaramos bajo nuestra sola responsabilidad que este producto está en conformidad con las normas o documentos normativos siguientes:

EN 60950-1, EN 301489-1, EN 301489-17, EN 300328 V2.1.1, EN 62479 de acuerdo con las regulaciones de las directivas 2014/53/EU, 2011/65/EU

**(I)** CE-17 - Dichiarazione di conformità **RED**. Dichiariamo sotto la nostra esclusiva responsabilità che questo prodotto è conforme alle seguenti norme e documenti normativi:

EN 60950-1, EN 301489-1, EN 301489-17, EN 300328 V2.1.1, EN 62479 conformemente alle disposizioni delle direttive 2014/53/EU, 2011/65/EU

**(P)** CE-17 - Declaração de conformidade **RED**. Declaramos sob nossa exclusiva responsabilidade que este produto cumpre as seguintes normas ou documentos normativos:

EN 60950-1, EN 301489-1, EN 301489-17, EN 300328 V2.1.1, EN 62479 conforme as disposições das directivas 2014/53/EU, 2011/65/EU

**(NL)** CE-17 - Konformiteitsverklaring **RED**. Wij verklaren en wij stellen ons er alleen voor verantwoordelijk dat dit produkt voldoet aan de volgende normen of normatieve documenten:

EN 60950-1, EN 301489-1, EN 301489-17, EN 300328 V2.1.1, EN 62479 overeenkomstig de bepalingen van de richtlijnen 2014/53/EU, 2011/65/EU

**(GR)** CE-17 - ΔΗΛΩΣΗ ΣΥΜΜΟΡΦΩΣΗΣ Μ **RED**. ε αναληψη συνολικης δηλωνομε οτι το πορον προιον συμφωνει με τα παρακατω ποστυπα και με τα ηροτυπα ηου αναφερονται στα σχεπκο εγγραφα

EN 60950-1, EN 301489-1, EN 301489-17, EN 300328 V2.1.1, EN 62479 συμφωνα με τοχς κονονισμοys 2014/53/EU, 2011/65/EU

**(S)** CE-17 - Konformitetsdeklaration **RED**. Vi förklarar på eget ansvar att denna produkt överensstämmer med följande normer eller normativa dokument:

EN 60950-1, EN 301489-1, EN 301489-17, EN 300328 V2.1.1, EN 62479 enligt bestämmelserna i direktiverna 2014/53/EU, 2011/65/EU

**(DK)** CE-17 - Konformitetserklæring **RED**. Vi erklærer under almindeligt ansvar at dette produkt er i overensstemmelse med følgende normer eller normative dokumenter:

EN 60950-1, EN 301489-1, EN 301489-17, EN 300328 V2.1.1, EN 62479 i henhold til bestemmelserne i direktiverne 2014/53/EU, 2011/65/EU

**(N)** CE-17 - Konformitetserklæring **RED**. Vi erklærer på eget ansvarlighet at dette produkt er i overensstemmelse med følgende standarder eller standard-dokumenter:

EN 60950-1, EN 301489-1, EN 301489-17, EN 300328 V2.1.1, EN 62479 i henhold til bestemmelserne i direktive ne 2014/53/EU, 2011/65/EU

**(FIN)** CE-17 - Todistus standardinmukaisuudesta **RED**. Asiasta vastava todistamme täten, että tämä tuote on seuraavien standardien ja standardoimisasiakirjojen vaatimusten mukainen:

EN 60950-1, EN 301489-1, EN 301489-17, EN 300328 V2.1.1, EN 62479 ja vastaa säädöksiä 2014/53/EU, 2011/65/EU

**(SK)** CE-17 - Prehlásenie o zhode **RED**. Prehlasujeme na vlastnú zodpovednosť, že tieto produkty sú v súlade s nasledovnými normami: EN 60950-1, EN 301489-1, EN 301489-17, EN 300328 V2.1.1, EN 62479 a v zhode so smernicami 2014/53/EU, 2011/65/EU

**(PL)** CE-17 - Zgodność z dyrektywami **RED**. Świadomi odpowiedzialności oświadczamy, że niniejszy produkt jest zgodny z następującymi normami lub dokumentacją normatywną: EN 60950-1, EN 301489-1, EN 301489-17, EN 300328 V2.1.1, EN 62479 zgodnie z postanowieniami wytycznych 2014/53/EU, 2011/65/EU

**(CZ)** CE-17 - Prohlášení o shode **RED**. Prohlašujeme na vlastní zodpovědnost, že tyto produkty splňují následující normy nebo normativní listiny: EN 60950-1, EN 301489-1, EN 301489-17, EN 300328 V2.1.1, EN 62479 Ve shode se smernicemi 2014/53/EU, 2011/65/EU

**(SLO)** CE-17 - Izjava o skladnosti **RED**. S tem potrjujemo splošno odgovornost, da je ta izdelek narejen v skladu z navedenimi normami in standardi

EN 60950-1, EN 301489-1, EN 301489-17, EN 300328 V2.1.1, EN 62479 ter določbami in smernicami 2014/53/EU, 2011/65/EU

**(HR)** CE-17 - Izjava o skladnosti **RED**. Pod punom odgovornošću izjavljujemo da je proizvod naveden u naslovu ovog dokumenta sukladan sa primijenjenim normama i normativnim dokumentima :

EN 60950-1, EN 301489-1, EN 301489-17, EN 300328 V2.1.1, EN 62479 u skladu sa odredbama preporuka 2014/53/EU, 2011/65/EU

**(H)** CE-17 - Megfelelősségi nyilatkozat **RED**. Kéziműködtetésű elektromos kéziszerszámok. Teljes felelősséggel kijelentjük, hogy ezek a termékek a következő szabványokkal és irányelvekkel összhangban vannak:

EN 60950-1, EN 301489-1, EN 301489-17, EN 300328 V2.1.1, EN 62479 és megfelelnek a rendeltetés 2014/53/EU, 2011/65/EU irányelveknek.

**(RO)** CE-17 - Declarație de conformitate **RED**. Noi declarăm pe propria răspundere că acest produs este în conformitate cu următoarele norme și documente normative:

EN 60950-1, EN 301489-1, EN 301489-17, EN 300328 V2.1.1, EN 62479 potrivit dispozițiilor directivelor 2014/53/EU, 2011/65/EU

Remscheid, den 02.11.2017



Joh. - Christoph Schütz

Dipl.-Ing. Joh.-Christoph Schütz, CE-Beauftragter