

# AGRO Kabelverschraubungen

## AGRO Cable Glands

Für professionelle Kabeleinführungen.  
For professional cable entries.

2026 / 2027



Progress® . Syntec® . EMV . Ex . Flanschwinkel . Zubehör  
Progress® . Syntec® . EMC . Ex . Flanged elbows . Accessories

 **AGRO**  
Member of KAISER GROUP



## Zukunft gestalten. Verantwortung leben.

Die **KAISER GROUP** vereint vier starke Marken – KAISER, AGRO, ATTEMA und HELIA – und steht für zukunftsweisende Lösungen in den Bereichen Elektro-Installation, Industrie und Connectivity. Als Familienunternehmen in dritter Generation verbinden wir Fortschritt und Tradition mit Innovationskraft und Qualität.

Im **Industriesegment** liegt unser Fokus auf zuverlässigen und präzisen Kabelverschraubungen, entwickelt und vertrieben unter der Marke AGRO. Unsere Produkte stehen für höchste Sicherheit, langlebige Materialien und effiziente Montage – für anspruchsvolle Anwendungen in modernen Industrie- und Infrastrukturprojekten weltweit.

Mit starken Ideen, Erfahrung und Leidenschaft schaffen wir Verbindungen, die Bestand haben – heute und in Zukunft.

*Burkard und Ulrich Kaiser*

## Shaping the future. Living responsibility.

The **KAISER GROUP** unites four established brands – KAISER, AGRO, ATTEMA and HELIA – and is synonymous with innovative solutions across the fields of electrical installation, industrial applications and fibre optic connectivity. As a third-generation family-run business, we combine tradition and progress with a spirit of innovation and a commitment to quality.

In the **industrial sector**, our emphasis lies on providing dependable and precision-engineered cable glands, designed and distributed under the AGRO brand. Our products embody maximum safety, robust materials and streamlined installation – engineered for demanding applications across contemporary industrial and infrastructure projects worldwide.

With bold ideas, proven expertise and genuine passion, we forge lasting connections – today and for generations to come.

*Burkard and Ulrich Kaiser*

**KAISER**  
Hauptsitz | Head office  
Deutschland | Germany  
www.kaiser-elektro.de



**AGRO**  
Schweiz | Switzerland  
www.agro.ch



**ATTEMA**  
Niederlande | Netherlands  
www.attema.com



**HELIA**  
Belgien | Belgium  
www.helia-elektro.be



Die **KAISER GROUP** steht europaweit für Innovation, Qualität und Kundennähe. Mit unseren Marken KAISER, AGRO, ATTEMA und HELIA schaffen wir verlässliche Lösungen für die Elektro-Installation, die Industrie und den Bereich Connectivity. Mit unserem starken Vertriebsnetz garantieren wir schnelle Verfügbarkeit, persönliche Beratung und Nähe zu unseren Kunden.

The **KAISER GROUP** is synonymous with innovation, quality and a strong customer focus across Europe. Through our brands, KAISER, AGRO, ATTEMA and HELIA, we deliver dependable solutions for electrical installation, industrial applications and connectivity. Thanks to our robust distribution network, we ensure swift availability, tailored guidance and close customer engagement.



## Nachhaltigkeit. Verantwortung übernehmen!

Nachhaltigkeit ist für uns gelebte Verantwortung – sozial, ökologisch und ökonomisch. Wir bieten sichere Arbeitsplätze, fördern Ausbildung und Inklusion und setzen auf lokale Produktion mit kurzen Lieferketten. Durch den Einsatz ressourcenschonender Technologien und transparente Prozesse gestalten wir Fortschritt verantwortungsvoll – für Mensch, Umwelt und Zukunft.

## Sustainability. Taking responsibility!

For us, sustainability is about embracing responsibility – socially, ecologically and economically. We provide stable employment, support training and inclusion, and prioritise local manufacturing with short supply chains. By applying resource-efficient technologies and transparent processes, we are driving responsible progress – for people, the environment and generations to come.

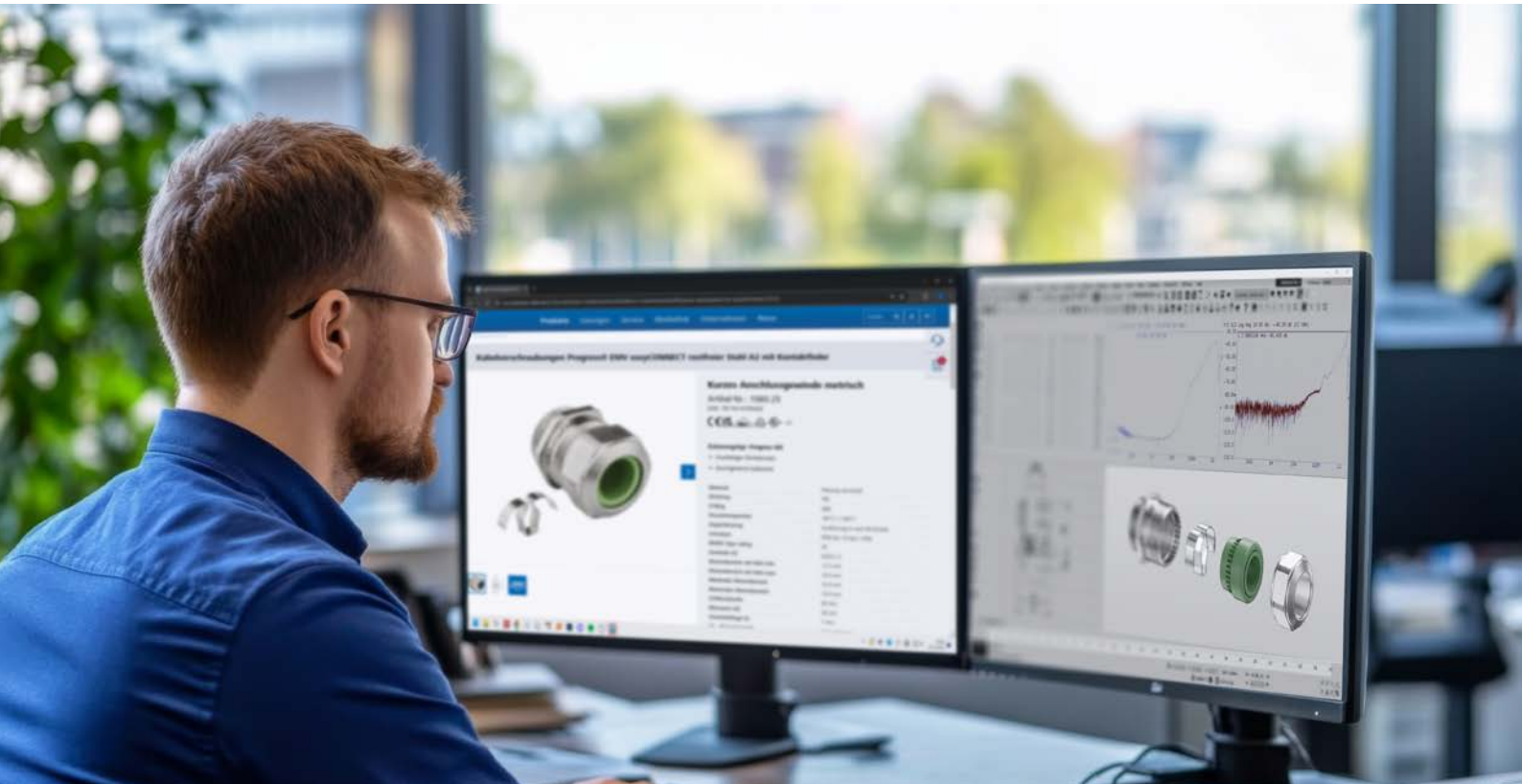

## **Service.** Informationen und Planungsunterlagen.

Entdecken Sie hilfreiche Filme, Tipps und Tricks rund um unsere Produkte und Anwendungen. Anschauliche Montageanleitungen, Zertifikate sowie Leistungs- und Konformitätserklärungen unterstützen Sie im Arbeitsalltag. Zudem bieten wir digitale Daten und Services, die Ihre Planung und Umsetzung erleichtern.

- Online-Produktkatalog
- Download digitaler Medien
- Seminare, Messen und Veranstaltungen
- Technische Vertriebs- und Serviceberatung
- Artikelstamm- und Preisdaten
- Ausschreibungstexte
- BIM-Daten
- CAD-Daten

## **Services.** Information and planning documents.

Discover helpful films, tips and tricks relating to our products and applications. Clear installation instructions, certificates and declarations of performance and conformity will support you in your everyday work. We also offer digital data and services to make your planning and implementation easier.

- Online product catalogue
- Download digital media
- Seminars, trade fairs and events
- Technical sales and service advice
- Article master and price data
- Tender texts
- BIM data
- CAD data



### **Artikeldaten.** **Article data.**

ETIM, Eldanorm, Datanorm,  
Excel, ELBRIDGE



### **Online-Service.** **Online services.**

BIM, CAD, EPLAN...



### **Videos.** **Movies.**

Montage und Funktion  
Installation and function



### **Schulungen.** **Trainings.**

Für Produkte und Lösungen  
For products and solutions



<b>Kabelverschraubungen Progress® Messing vernickelt</b> Cable glands Progress® nickel-plated brass		1
<b>Kabelverschraubungen Progress® rostfreier Stahl A2 / A4</b> Cable glands Progress® stainless steel A2 / A4		2
<b>Spezielle Kabelverschraubungen und Kabeleinführungen Messing vernickelt</b> Special cable glands and cable entries nickel-plated brass		3
<b>EMV Kabelverschraubungen Progress® Messing vernickelt</b> EMC cable glands Progress® nickel-plated brass		4
<b>EVolution EMC Komponenten</b> EVolution EMC components		5
<b>Mehrfachdurchführung MCE Pro</b> Multi-cable entry MCE Pro		6
<b>Kabelverschraubungen Progress® Messing nach EN 45545</b> Cable glands Progress® nickel-plated brass according to EN 45545		7
<b>Ex Kabelverschraubungen Messing oder Kunststoff</b> Ex cable glands nickel-plated brass or synthetic		8
<b>Kabelverschraubungen Progress® AgreenO Messing bleifrei</b> Progress® AgreenO cable glands of lead-free brass		9
<b>Kombi-Schlauchverschraubungen Messing vernickelt mit integrierter Kabelverschraubung</b> Combination conduit glands nickel-plated brass with integrated cable gland		10
<b>Kabelverschraubungen Progress® Kunststoff</b> Synthetic cable glands Progress®		11
<b>Kabelverschraubungen Syntec® Messing vernickelt und Kunststoff</b> Cable glands Syntec®, nickel-plated brass or synthetics		12
<b>Spezielle Kabelverschraubungen und Kabeleinführungen Kunststoff</b> Special cable glands and cable entries synthetic		13
<b>Zubehör zu Kabelverschraubungen Kunststoff oder Metall</b> <b>AGROflex Geflechschläuche</b> Accessories for cable glands synthetic or metal AGROflex braided sleeveings		14
<b>Zusatzinformationen / Sonderlösungen</b> Additional information / Special solutions		15

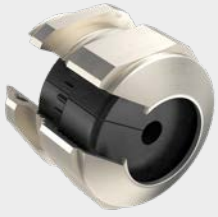

## Progress® Kabelverschraubung mit geschlitzten Dichteinsätzen.

Für Kabel mit konfektionierten Steckern.

Kabelverschraubungen mit geschlitzten Dichteinsätzen ermöglichen die einfache Durchführung vorkonfektionierter Kabel mit Steckern (Ø 15–28 mm), ohne Demontage der Stecker. Der im Unterteil integrierte Verdrehschutz verhindert ein Mitdrehen des Kabels, erleichtert die Montage und trägt zur langfristigen Dichtigkeit bei. Zudem bleibt die Herstellergarantie der vorkonfektionierten Kabel vollständig erhalten.

Dank hoher Schutzarten IP54 und IP68 sind die Kabel zuverlässig gegen Staub und Wasser geschützt. Erhältlich in Kunststoff, Messing und Edelstahl, deckt das Sortiment in den Grössen M20 bis M40 Kabeldurchmesser von 3 bis 8 mm ab. Die einfache und zeitsparende Installation macht die Verschraubungen ideal für vielseitige Anwendungen – von Telekommunikation über industrielle Automatisierung bis zu erneuerbaren Energien.

## Progress® cable glands with split sealing inserts.

For cables with pre-assembled connectors.

Cable glands with split sealing inserts allow easy feedthrough of cables with pre-fitted connectors (Ø 15–28 mm) without removing the connectors. The anti-rotation design feature of the lower part prevents the cable from turning, simplifies installation and contributes to long-term sealing. The validity of manufacturer warranties for pre-assembled cables is not affected.

Thanks to high protection classes IP54 and IP68, the cables are reliably protected against dust and water. Available in plastic, brass and stainless steel, the product range in sizes M20 to M40 covers cable diameters from 3 to 8 mm. Simple and time-saving installation makes the cable glands ideal for a wide range of applications – from telecommunications and industrial automation to renewable energies.



## Kantenschutz.

Effektiver und nachhaltiger Schutz vor Abrieb und Isolationsdefekten.

Unser innovativer und kompakter Kantenschutz verhindert den Abrieb des Kabelmantels auf der Gewindeseite der Kabelverschraubung und schützt nachhaltig vor Isolationsdefekten und Druckstellen. Verfügbar in metrischen Ausführungen, eignet er sich besonders bei beengten Platzverhältnissen sowie für Kabel mit grossen und kleinen Durchmessern. Bei Kabeln mit grossen Querschnitten kann er das hohe Eigengewicht abfedern. Für die nachträgliche Montage kann der Kantenschutz geteilt werden, wodurch Nacharbeiten entfallen und die Lebensdauer der Kabel erhöht wird. Zudem erfüllt er die Anforderungen der EN 45545-2 HL3.

## Edge protection for cables.

Effective and long-lasting protection against cable abrasion and defects.

Our innovative and compact edge protectors prevent abrasion of the cable sheath on the threaded side of the cable gland and provide lasting protection against damage to insulation, preventing indentations. Available in a range of metric sizes, they are particularly suitable for use in tight spaces and on cables with large or small diameters. In the case of cables with large cross-sections, they can cushion the cables' weight. The edge protectors can be split for placing on previously installed cables, eliminating rework and increasing the service life of the cables. They also meet the requirements of EN 45545-2 HL3.



## Progress® EMV powerCONNECT.

Direkte Anschluss-technik für hohe  
Ableitströme auf kleinstem Raum.

Die Progress® EMV powerCONNECT mit der neuartigen fortschrittlichen Presshülse garantiert eine sichere 360° Schirmkontaktierung auf kleinstem Raum. Der direkte Übergang vom Geflecht auf das Unterteil der Kabelverschraubung gewährleistet einen erstaunlich niedrigen Übergangswiderstand.

## Progress® EMC powerCONNECT.

Direct connection technology for high  
leakage currents in a compact unit.

Progress® EMC powerCONNECT, with its innovative, advanced compression sleeve, ensures reliable 360° shield contact in a very compact unit. The direct transfer from the shielding to the cable gland's lower part ensures extremely low transfer resistance.

## EVolution EMC.

Die erste EMV-Kabelverschraubung mit gecrimpter und steckbarer EMV-Schirmkontaktlösung.

Verblüffend einfach und robust: Die steckbare EMV-Kontaktlösung macht die EVolution EMC enorm leistungsfähig. Durch die einzigartige Konstruktionsweise der Schirmkontaktlösung ist sie die erste EMV-Kabelverschraubung mit Servicefunktion.

## EVolution EMC.

The first EMC cable gland with a crimped and "pluggable" EMC shield contact solution.

Amazingly simple and robust: The "pluggable" (easily disconnectable) EMC shield contact solution makes the EVolution EMC extremely powerful. Due to the unique design of this shield contact solution, it is the first EMC cable gland that is designed to facilitate maintenance and repair.



## Hydraulikschlauch Adapter Progress® Messing.

Zuverlässige Leistung unter Extrembedingungen.

Unsere Hülse ermöglicht eine präzise Fixierung und Abdichtung Ihrer Hydraulikschläuche, verfügbar für die Innendurchmesser (DN/ID) 25 mm und 16 mm. Die Verschraubung erfüllt die Normen EN 45545-2 HL3 sowie NFPA 130. Das Produkt bietet eine Schutzart von IP 68 und IP 69 zu Kabel und Schlauch, sodass sie auch bei widrigen Bedingungen sicher eingesetzt werden kann.

## Progress® brass hydraulic hose adapter.

Reliable performance under extreme conditions.

Our connection solution, available with an inner diameter (DN/ID) of 25 mm or 16 mm, enables your hydraulic hoses to be precisely secured and perfectly sealed. The fitting meets the requirements of EN 45545-2 HL3 and NFPA 130, and offers a protection rating of IP 68 and IP 69 to both cable and hose pipe, making it reliable for use even in adverse conditions.



## Druckausgleichselement aus rostfreiem Stahl A4

Die schlagfeste Innovation mit Hochleistungsmembrane.

Die Hochleistungsmembrane sorgt für schnellen, sicheren Luftaustausch und erreicht Schutzarten bis IP69 und IP6K9K. Zusätzlich ist das Element schlagfest nach IK10. Druckunterschiede und Feuchtigkeit, wie sie in Beleuchtung, Energieverteilung, Verkehrstechnik oder Solaranlagen auftreten, werden zuverlässig ausgeglichen. Korrosionen und Ausfälle werden verhindert.

## Pressure balance elements of A4 stainless steel

The impact-resistant innovation with a high-performance membrane.

The high-performance membrane ensures fast, controlled air exchange and achieves protection ratings up to IP69 and IP6K9K. The product is also impact-resistant to IK10. Moisture and pressure differences – as may occur in lighting, power distribution, traffic engineering or solar energy systems, for example – are reliably balanced. Corrosion and interruptions to service are prevented.



## AGRO kundenspezifische Lösungen.

Wir machen sie möglich.

Als kompetenter Partner bieten wir nicht nur ein breites Standard-Sortiment, sondern entwickeln auch kundenspezifische Lösungen, passend für individuelle Anwendungsfälle.

Schon in der Entwicklungsphase beraten wir Sie bei der Umsetzung Ihrer Projekte. Dadurch ist es möglich, die hohen Anforderungen Ihrer Produkte an Funktionalität und Design unter wirtschaftlichen Gesichtspunkten gemeinsam zu gestalten.

- Viele Lösungen aus unserem Progress® Baukasten sind schnell und einfach realisierbar
- Individuelle Systemlösungen für spezielle Anforderungen
- Umfangreiche Beratung und Bemusterung bereits in der Entwicklungsphase

## AGRO customised solutions.

We make it possible.

As your competent partner, we not only offer a wide range of standard products, but also develop customised solutions to accommodate your specific needs.

Already in the development phase, we will be pleased to provide advice on the implementation of your projects. This will enable us to jointly define the specific requirements of your products in terms of functionality and design while considering economic efficiency.

- Many solutions can be implemented quickly and easily using the modular components of our Progress® system
- Individual system solutions for special requirements
- Comprehensive advice and provision of samples as early as the development phase



# Systeme und Lösungen für Industrie und Elektroinstallation. Systems and solutions for industrial applications and electric installations.



**Im Verkehrswesen** kommt es vor allem auf den sicheren Halt der Zuleitung an. Die in der Bahntechnik verwendeten Progress®-Kabelverschraubungen lockern sich trotz hoher Rüttelbelastungen nicht. Daher ermöglichen sie eine einwandfreie Strom- und Signalübertragung im gesamten Schienenfahrzeug. Es sind zertifizierte Dichteinsätze für Schienenfahrzeuge nach EN 45545 und NFPA 130 verfügbar.

**In the field of transportation**, secure gripping of electrical cables is vital. The Progress® cable glands used in railway technology do not become loose, despite strong vibrations. This enables power and signals to be reliably transmitted throughout the train. Certified sealing inserts are available for railway applications, according to EN 45545 and NFPA 130.



Messing oder Kunststoff Syntec® Kabelverschraubungen sind die ideale Lösung für vielfältige **tägliche Aufgaben**. Die einzigartige patentierte Lamellentechnik klemmt das Kabel auf schonende Art und Weise und garantiert eine sichere Kabeleinführung mit hervorragender Zugentlastung.

Nickel-plated brass or synthetic Syntec® cable glands represent the optimal solution for a wide range of **daily tasks**. The patented, unique lamellar technology clamps the cable in a protective way and ensures a reliable cable entry with outstanding strain relief.



Durch Staub und Abgase entsteht ein beträchtliches Mass an chemischer Belastung in **Tunneln**. Diese erfordert den Einsatz von rostfreien und säurebeständigen Kabelverschraubungen aus rostfreiem Stahl A4 mit FPM Dichteinsatz. Kabeldurchmesser von 2.0 mm bis 52.0 mm können sicher eingeführt werden.

Dust and exhaust emissions cause high levels of chemical pollution in **tunnels**. This calls for the use of stainless and acid-resistant A4 steel cable glands with FPM sealing insert. These can be used to reliably accommodate cables of diameter 2.0 mm to 52.0 mm.



Kabelverschraubungen für den Einsatz im **Schiffsbau** müssen spezifische Anforderungen erfüllen. Ein DNV-Zertifikat bescheinigt die Erfüllung dieser Anforderungen. Alle metrischen AGRO Kabelverschraubungen sind DNV zertifiziert. Unabhängig von ihrem Gewinde sind zusätzlich alle AGRO Ex-Kabelverschraubungen für den Einsatz im Schiffsbau zugelassen.

For the **shipbuilding industry**, cable glands have to meet specific requirements. DNV certification confirms the fulfillment of such requirements. All metric AGRO cable glands are DNV-certified. All AGRO Ex cable glands are also approved for shipbuilding applications, irrespective of their entry thread.



Elektronisch gesteuerte **Umspannstationen** funktionieren so lange reibungslos, wie keine Signale durch Störströme verfälscht werden. Der konzentrische Schirmabgriff der Progress® EMV Kabelverschraubungen führt Störströme auf Masse und garantiert kleinste Transferimpedanzen.

Les **installations de postes de transformation commandées électroniquement** ne fonctionnent sans accroc que si les signaux ne sont pas perturbés par des courants parasites. La fixation concentrique du blindage des presse-étoupes Progress® CEM conduit ces courants parasites à la masse et garantit le plus faible transfert d'impédance.



In der **Lebensmittelindustrie** kommen keimtötende Substanzen zum Einsatz. Diese Substanzen garantieren auf der einen Seite die Hygiene und stellen auf der anderen Seite besondere Anforderungen an die eingesetzten Materialien der Produktionsmittel. Progress® aqua haben die KTW W270 Zulassung und können bedenkenlos in Trinkwasseranlagen eingesetzt werden.

In the **food industries**, anti-bacterial substances are used to ensure a high level of safety. These substances, however, also present a particular challenge for the materials used in the production facilities. Progress® aqua cable glands are KTW W270-certified for drinking water applications.



**Raffinerien** und Produktionsanlagen der chemischen Industrie mit explosionsgefährdeten Bereichen stellen besondere Anforderungen an die elektrische Installation. AGRO bietet zertifizierte Kabelverschraubungen für druckfeste Kapselung Ex d IIC, für erhöhte Sicherheit Ex e II und für Eigensicherheit Ex i II an.

**Refineries** and production facilities in the chemical industry with potentially explosive areas make specific demands on electrical installations. AGRO offers certified cable glands for "flameproof enclosures" (Ex d IIC), for "increased safety" (Ex e II) and for "intrinsic safety" (Ex i II).



Bei der Realisierung von **Windkraftanlagen** bietet die Progress®-Baureihe eine kabelschonende Zugentlastung mit hoher Verdreh-sicherheit. Dabei spielt es keine Rolle, ob es sich um Rundkabel oder Flachleitungen handelt.

For the construction of **wind power stations**, the Progress® range offers cable-protecting strain relief with good protection against cable rotation – regardless of whether the cables are round or flat.



## Professionelle Lösungen für die sichere Kabeleinführung

**Progress® Kabelverschraubungen** bieten ein umfangreiches Sortiment aus Kunststoff, Messing oder rostfreiem Stahl A2 / A4 und sind bewährte Helfer für die fachgerechte Kabeleinführung in Industrieanlagen. Die herausragende Kompressionstechnik sorgt für eine hohe Dichtigkeit und eine äusserst kabelschonende Zugentlastung.

Kabelverschraubungen Progress® aus Metall können mit Dichteinsätzen aus einem speziellem TPE bestückt werden. In dieser Ausführung sind sie zertifiziert nach EN 45545 sowie NFPA 130.

**Progress® EMV-Kabelverschraubungen** aus Messing oder Edelstahl sorgen für eine niederimpedante Verbindung zwischen Schirmgeflecht und Metallgehäuse bei einer gleichzeitig sicheren Kabeleinführung.

**Progress® Ex-Kabelverschraubungen** aus Kunststoff oder Messing sorgen auch in explosionsgefährdeten Bereichen für eine sichere Kabeleinführung.

**Syntec® Kabelverschraubungen** aus Kunststoff oder Messing sind die optimale Lösung für Ihre täglichen Installations-Aufgaben. Die überragend, einzigartige Lamellentechnik garantiert immer eine praxisgerechte Kabeleinführung, bei hervorragender Zugentlastung.

## Professional solutions for a safe cable entry

**Progress® cable glands** made of synthetics, nickel-plated brass or stainless steel A2 / A4 are proven aids for professional cable entry in industrial plants. The excellent compression technology ensures tight seals and strain relief which is exceptionally easy on cables. Progress® cable glands made of metal are certified for railway applications according to EN 45545 and NFPA 130.

**Progress® EMC cable glands** made of nickel-plated brass ensure a low-impedance connection between the braided shield and the metal housing while maintaining secure cable entry.

**Progress® Ex cable glands** made of synthetics or nickel-plated brass ensure secure cable entry even in potentially explosive environments.

**Syntec® cable glands** made of synthetics or nickel-plated brass are the optimal solution for your daily installation tasks. The outstanding, unique lamellar technology always guarantees cable entry with excellent strain relief.

	<i>Progress® Messing Progress® nickel-plated brass</i>	<i>Progress® rostfreier Stahl A2 / A4 Progress® stainless steel A2 / A4</i>	<i>Spezielle Kabelverschraubungen Special cable glands</i>	<i>EMV Progress® Messing EMC Progress® nickel-plated brass</i>	<i>Ex Messing oder Kunststoff Ex nickel-plated brass or synthetic</i>	<i>Kombi-Schlauchverschraubungen Combination conduit glands nickel-plated brass</i>	<i>Progress® Kunststoff Progress® synthetic</i>	<i>Syntec® Messing und Kunststoff Syntec® synthetic and nickel-plated brass</i>	<i>Spezielle Kabelverschraubungen Special cable glands</i>	<i>Spezielle Kabelverschraubungen Special cable glands</i>
Kapitel Chapter	1 / 7 / 9	2	3	4	8	10	11	12	13	
<b>Ausführung / Design</b>										
Kompressionstechnik Compression technology	•	•	•	•	•	•	•	-	•	
Lamellentechnik Lamellar technology	-	-	-	-	-	-	-	•	-	
<b>Gewinde / Thread</b>										
Anschlussgewinde metrisch Entry thread metric	•	•	•	•	•	•	•	•	•	
Anschlussgewinde Pg Entry thread Pg	•	•	•	•	•	•	•	•	•	
Anschlussgewinde NPT Entry thread NPT	•	-	-	-	•	-	-	•	-	
Anschlussgewinde Gasrohr Entry thread gas-pipe	•	-	-	-	•	-	-	-	-	
Kurzes Anschlussgewinde Short entry thread	•	-	•	•	•	•	-	•	•	
Langes Anschlussgewinde Long entry thread	•	•	•	•	•	•	•	•	-	
<b>Dichteinsatz / Sealing insert</b>										
Für Rundkabel For round cables	•	•	•	•	•	•	•	•	•	
Für Flachkabel For flat cables	•	-	-	-	-	-	A	-	-	
Für mehrere Kabel For mutiple cables	•	A	-	-	•	A	•	-	-	
TPE/NBR-Dichteinsatz (bis 100°C) TPE/NBR sealing insert (up to 100°C)	•	•	•	•	•	•	•	•	•	
FPM-Dichteinsatz (bis 200°C) FPM sealing insert (up to 200°C)	•	•	-	•	-	-	-	-	-	
EPDM Dichteinsatz KTW W270 EPDM sealing insert KTW W270	-	•	-	-	-	-	-	-	-	
Spezial TPE für EN 45545 Special TPE for EN 45545	•	•	•	•	-	•	-	-	A	
<b>Technische Besonderheiten / Technical features</b>										
Knickschutz Anti-kink protection	•	-	-	•	-	-	-	•	-	
Biegeschutz Bending protection	•	-	•	-	•	-	-	-	-	
Externe Zugentlastung External strain relief	•	-	•	•	•	-	-	-	-	
Für Schlauchanschluss For conduit connection	•	-	-	-	-	•	-	-	-	
<b>Material / Material</b>										
Polyamid Polyamide	-	-	-	-	-	-	-	•	•	
Polyamid glasfaserverstärkt Polyamide – glass fibre reinforced	-	-	-	-	-	-	•	-	-	
Messing vernickelt Nickel-plated brass	•	-	•	•	•	•	-	•	-	
Messing vernickelt bleifrei Lead-free nickel-plated brass	•	-	•	•	-	A	-	A	-	
Rostfreier Stahl A2/A4 Stainless steel A2/A4	-	•	-	-	•	-	-	-	-	

A = auf Anfrage / upon request

# AGRO Kabelverschraubungen Progress® Messing

## AGRO Progress® cable glands nickel-plated brass

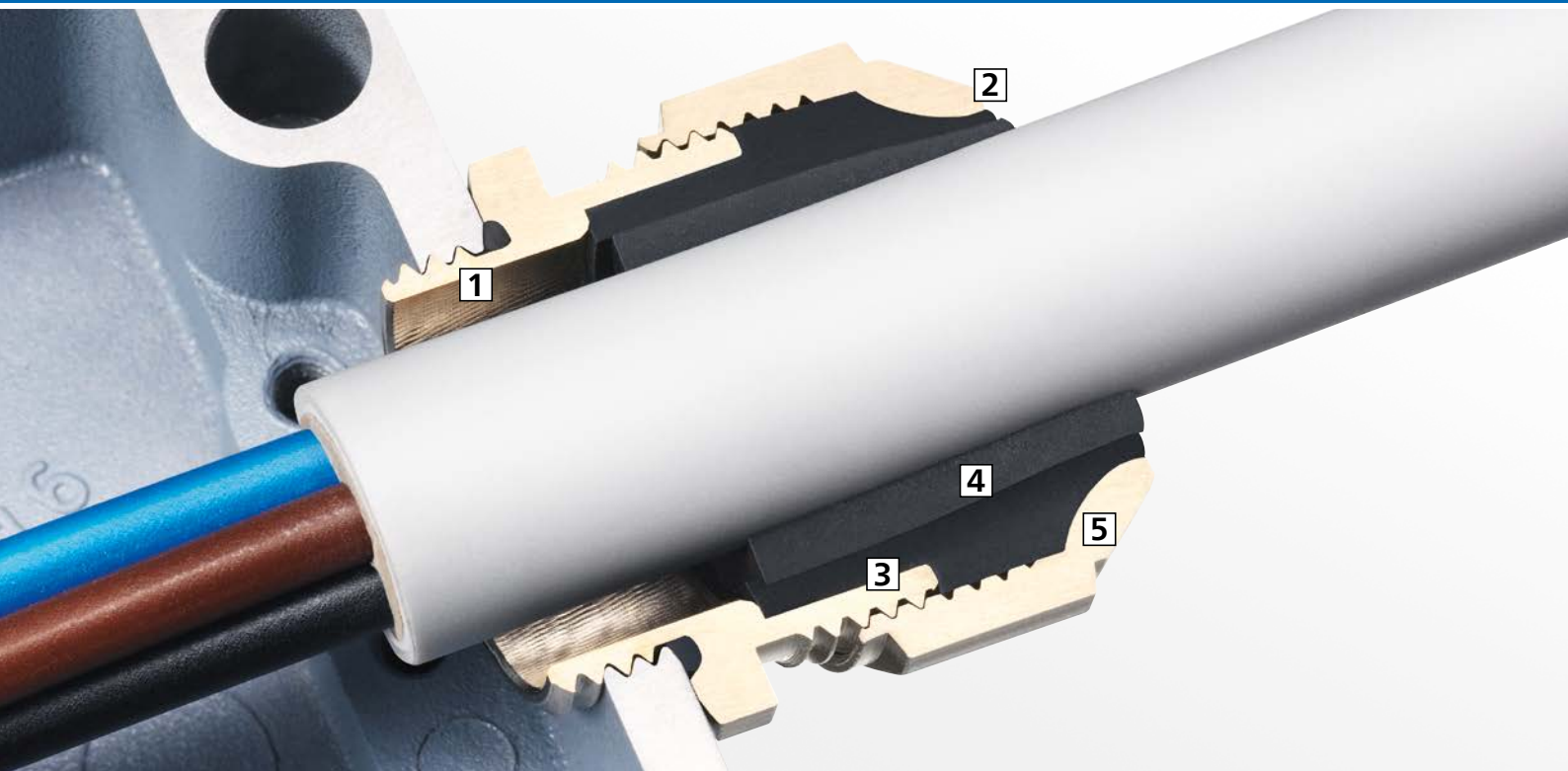

**AGRO Kabelverschraubungen Progress® Messing vernickelt** sind bewährte Helfer für die fachgerechte Kabeleinführung in Industrieanlagen. Durch die richtige Wahl mit dem passenden Dichteinsatz sind sie überall einsetzbar. Die herausragende Kompressionstechnik sorgt für eine hohe Dichtigkeit und eine äusserst kabelschonende Zugentlastung auch bei dynamischen Belastungen.

AGRO Progress® Kabelverschraubungen aus Metall mit Dichteinsätzen aus einem speziellen TPE sind zertifiziert nach EN 45545 sowie NFPA 130 und können bedenkenlos für alle Anwendungen und Anordnungen im Schienenfahrzeugbau eingesetzt werden.

### 1 Kurze, lange oder Spezial-Anschlussgewinde

Kabelverschraubungen Progress® mit kurzem oder langem Anschlussgewinde in metrischer, Pg-, Gasrohr oder NPT-Ausführung können bei vorhandenem Öffnungsgewinde oder mit Gegenmutter verwendet werden.

### 2 Sichtbare Sicherheit

Der kleine Wulst des Dichteinsatzes bestätigt das richtige Anzugsdrehmoment.

### 3 Hoher Verdrehschutz

Die im Unterteil integrierte Längsrandrierung sorgt über den Dichteinsatz für eine hohe Verdrehsicherheit.

### 4 Grosse Flexibilität

Zweiteilige Dichteinsätze können in Sekundenschnelle vor Ort auf den vorhandenen Kabeldurchmesser angepasst werden.

### 5 Garantierte Dichtigkeit

Auf den Dichteinsatz abgestimmte Innenkonturen sorgen für eine zielgerichtete Verformung des Dichteinsatzes und garantieren somit dessen perfekte Abdichtung. Die Schutzart IP 68 bis 10 bar sowie IP 69 ermöglichen eine breite Anwendung.

**Cable glands Progress® nickel-plated brass** are tried and tested aids for high-quality cable entries in industrial equipment. Correctly selected and with the right sealing insert, they can be used anywhere. The outstanding compression technology ensures an effective seal and excellent cable-protecting strain relief, also in the case of dynamic loading.

AGRO Progress® metal cable glands equipped with sealing inserts made of special TPE are certified according to EN 45545 and NFPA 130, and can be used with confidence for any rolling stock application.

### 1 Short, long or special entry thread

Progress® cable glands with short or long entry thread with metric, Pg, imperial or NPT designs can be used with existing hole threads or with a counter nut.

### 2 Visible reliability

A slight bulging of the sealing insert confirms the correct tightening torque.

### 3 Good anti-rotation protection

The longitudinal knurling (surface texture) applied to the cable gland's lower part provides a high degree of protection against rotation via the sealing insert.

### 4 Great flexibility

It only takes a few seconds to adapt the two-part sealing insert on site to the existing cable diameter.

### 5 Reliable leak-tightness

Inner contours matched to the sealing insert ensure a targeted deformation of the insert and thus ensure its leak-tightness in compliance with protection class IP 68 up to 10 bar and IP 69K for a wide range of applications.

## Progress®: Der Baukasten Progress®: Modular assembly system

Der modulare Aufbau unserer Kernserie **Progress®** ist eine ihrer ganz grossen Stärken. Die Bauteile sind aufeinander abgestimmt und können frei kombiniert werden.

The modular design of our Progress® range is one of its great strengths. The components are designed with the others in mind, and can be freely combined with each other.

### Standard Oberteile Standard upper parts



Knickschutz  
Anti-kink spring



Klemmbacken  
Clamping Jaws



Trompete  
Trumpet-piece



Klemmbacken  
und Trompete  
Clamps and  
trumpet-piece



Schlauch-  
verschraubung  
Conduit gland



Standard-  
Druckmutter  
Standard  
compression nut

### Standard Dichteinsätze Standard sealing inserts



Kurzer ein- oder zweiteiliger Dichteinsatz in NBR, TPE, Spezial TPE nach EN 45545 oder FPM (temperaturbeständig)

Short one- or two-piece sealing insert made of NBR, TPE, special TPE according to EN 45545 or FPM (heat resistant)

Langer durchgehend isolierender Dichteinsatz in NBR, TPE, Spezial TPE nach EN 45545 ein oder zweiteilig

Long one- or two-piece full-length insulating sealing insert made of NBR, TPE or special TPE according to 45545

Für die gängigsten Kabeldurchmesser sind Dichteinsätze für die Durchführung mehrerer Kabel verfügbar

For the most common cable diameters, sealing inserts are available for the entry of several cables at once

### Standard Unterteile Standard lower parts



Mit kurzem Anschlussgewinde  
With short entry thread

- Metrisch / Metric
- Pg
- NPT
- Gasrohrgewinde / Gas pipe



Mit langem Anschlussgewinde  
With long entry thread

- Metrisch / Metric
- Pg
- NPT
- Gasrohrgewinde / Gas pipe

	Progress® Messing Progress® nickel-plated brass	Standard	Für hohe Temperaturen For high temperatures	Für mehrere Kabel For multiple cables	Mit Dichteinsatz Sealing insert with no hole	Für spezielle Kabel For special cables	Mit speziellem Anschlussgewinde With special entry thread	Mit Knickschutzfeder With anti-kink spring	Mit Klemmbacken With clamps	Mit Trompete With trumpet-piece	Mit Trompete und Klemmbacken With trumpet-piece and clamps
<b>Ausführung / Design</b>											
Kompressionstechnik Compression technology	•	•	•	•	•	•	•	•	•	•	•
<b>Gewinde / Thread</b>											
Anschlussgewinde metrisch Entry thread metric	•	•	•	•	•	•	•	•	•	•	•
Anschlussgewinde Pg Entry thread Pg	•	•	•	•	•	•	•	•	•	•	•
Anschlussgewinde NPT Entry thread NPT	•	-	-	-	-	-	-	-	-	-	-
Anschlussgewinde Gasrohr Entry thread Gas pipe	•	-	-	-	-	-	-	-	-	-	-
Kurzes Anschlussgewinde (Standard) Short entry thread (standard)	•	•	•	•	•	•	•	•	•	•	•
Langes Anschlussgewinde Long entry thread	•	•	•	•	•	-	•	•	•	•	•
Sondergewinde (extra lang, Innengewinde) Special thread (extra long, internal thread)	•	-	-	-	-	•	-	-	-	-	-
<b>Dichteinsatz / Sealing insert</b>											
Für Rundkabel For round cable	•	•	•	-	-	•	•	•	•	•	•
Für Flachkabel For flat cable	•	-	-	-	•	-	-	-	-	-	-
Für mehrere Kabel (Multi-Dichteinsatz) For multiple cables (Multi-sealing insert)	•	-	•	-	-	-	-	-	-	-	-
Vollgummi-Dichteinsatz Full rubber sealing insert	•	•	-	•	-	-	-	-	-	-	-
Einteiliger Dichteinsatz One-piece sealing insert	•	•	•	•	•	-	•	•	-	-	-
Zweiteiliger Dichteinsatz Two-piece sealing insert	•	•	-	-	-	•	•	•	•	•	•
multiLAYER Dichteinsatz multiLAYER sealing insert	•	-	-	-	-	A	A	A	A	A	A
Spezial TPE nach EN45545 Special TPE acc. to EN 45545	•	-	•	•	•	•	•	•	•	•	•
<b>Technische Besonderheiten / Technical features</b>											
Vibrationschutz Vibration resistance	•	•	•	•	•	•	•	•	•	•	•
<b>Material / Material</b>											
Messing vernickelt Nickel-plated brass	•	•	•	•	•	•	•	•	•	•	•

A = Auf Anfrage / A = upon request



<p>Kabelverschraubungen Progress® Messing Cable glands Progress® nickel-plated brass</p>		<p>16 - 29</p>	<p>1</p>
<p>Kabelverschraubungen Progress® Messing für hohe Temperaturen Cable glands Progress® nickel-plated brass for high-temperature applications</p>		<p>30 - 33</p>	<p>2</p>
<p>Kabelverschraubungen Progress® Messing für mehrere Kabel Cable glands Progress® nickel-plated brass for installation of multiple cables</p>		<p>34 - 39</p>	<p>3</p>
<p>Kabelverschraubungen Progress® Messing mit Dichteinsatz ohne Bohrung Cable glands Progress® nickel-plated brass with sealing insert without a hole</p>		<p>40 - 41</p>	<p>4</p>
<p>Kabelverschraubungen Progress® Messing für Flachkabel Cable glands Progress® nickel-plated brass for flat cables</p>		<p>42 - 44</p>	<p>5</p>
<p>Kabelverschraubungen Progress® Messing mit speziellem Anschlussgewinde Cable glands Progress® nickel-plated brass with special entry thread</p>		<p>45 - 46</p>	<p>6</p>
<p>Kabelverschraubungen Progress® Messing mit Knickschutztülle EPDM Cable glands Progress® nickel-plated brass with antikink nozzle EPDM</p>		<p>47</p>	<p>7</p>
<p>Kabelverschraubungen Progress® Messing mit Knickschutzfeder Cable glands Progress® nickel-plated brass with anti-kink spring</p>		<p>48 - 49</p>	<p>8</p>
<p>Kabelverschraubungen Progress® Messing mit Klemmbacken Cable glands Progress® nickel-plated brass with clamps</p>		<p>50 - 54</p>	<p>9</p>
<p>Kabelverschraubungen Progress® Messing mit Trompete Cable glands Progress® nickel-plated brass with trumpet-piece</p>		<p>55 - 56</p>	<p>10</p>
<p>Kabelverschraubungen Progress® Messing mit Trompete und Klemmbacken Cable glands Progress® nickel-plated brass with trumpet-piece and clamps</p>		<p>57 - 58</p>	<p>11</p>

# Kabelverschraubungen Progress® Messing

## Cable glands Progress® nickel-plated brass

### Kurzes Anschlussgewinde metrisch | Short entry thread metric

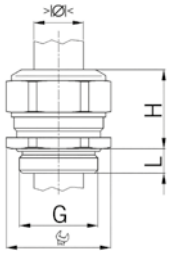

Material: Messing vernickelt  
 Dichtung: TPE / NBR  
 O-Ring: NBR  
 Zugentlastung: Ausführung A nach EN 62444  
 Schutzart: IP 68 (bis 10 bar) / IP 69  
 NEMA Type rating: 4X  
 Einsatztemperatur: -40 °C / +100 °C

Material: Nickel-plated brass  
 Seal: TPE / NBR  
 O-ring: NBR  
 Strain relief: Version A acc. to EN 62444  
 Protection class: IP 68 (up to 10 bar) / IP 69  
 NEMA Type rating: 4X  
 Operation temperature: -40 °C / +100 °C



Progress MS



Einteiliger Dichteinsatz  
 Nicht durchgehend isolierend

One-piece sealing insert  
 not overall length insulated

G	>math>\varnothing</math> min mm	>math>\varnothing</math> max mm	mm	H mm	L mm	i info	Art.-No.	
M6x1.0	2.0	2.5	8	12	5	1	1000.06.025	50
M6x1.0	2.5	3.0	8	12	5	1	1000.06.030	50
M6x1.0	3.0	3.5	8	12	5	1	1000.06.035	50
M8x1.25	2.5	3.5	11	14	5	1	1000.08.035	50
M8x1.25	3.5	5.0	11	14	5	1	1000.08.050	50
M10x1.5	3.0	4.0	13	15	5	1	1000.10.040	50
M10x1.5	4.0	6.0	13	15	5	1	1000.10.060	50
M12x1.5	3.5	5.0	15	17	5	-	1000.12.050	50
M12x1.5	5.0	6.5	15	17	5	-	1000.12.065	50
M12x1.5	6.5	8.0	15	17	5	-	1000.12.080	50
M16x1.5	3.5	4.5	18	20	5	-	1000.17.045	50
M16x1.5	4.5	6.0	18	20	5	-	1000.17.060	50
M16x1.5	6.0	8.0	18	20	5	-	1000.17.080	50
M16x1.5	8.0	10.5	18	22	5	-	1000.17.105	50
M20x1.5	6.0	8.0	24	21	6	-	1000.20.080	50
M20x1.5	8.0	11.0	24	21	6	-	1000.20.110	50
M20x1.5	11.0	15.0	24	23	6	-	1000.20.150	50
M25x1.5	9.5	12.5	30	25	7	-	1000.25.125	25
M25x1.5	12.5	16.0	30	27	7	-	1000.25.160	25
M25x1.5	16.0	20.5	30	28	7	-	1000.25.205	25
M32x1.5	14.0	17.0	36	28	8	-	1000.32.170	25
M32x1.5	17.0	21.0	36	28	8	-	1000.32.210	25
M32x1.5	21.0	25.5	36	28	8	-	1000.32.255	25
M40x1.5	20.0	24.0	46	31	8	-	1000.40.240	10
M40x1.5	24.0	28.5	46	31	8	-	1000.40.285	10
M40x1.5	28.5	33.0	46	31	8	-	1000.40.330	10
M50x1.5	29.0	33.0	55	34	9	-	1000.50.330	10
M50x1.5	33.0	37.0	55	34	9	-	1000.50.370	10
M50x1.5	37.0	42.0	55	34	9	-	1000.50.420	10
M63x1.5	35.0	40.0	70	37	10	-	1000.63.400	5
M63x1.5	40.0	46.0	70	37	10	-	1000.63.460	5
M63x1.5	46.0	52.0	70	37	10	-	1000.63.520	5
M75x1.5	45.0	50.0	80	38	11	-	1000.75.500	1
M75x1.5	50.0	56.0	80	38	11	-	1000.75.560	1
M75x1.5	56.0	63.0	80	38	11	-	1000.75.630	1
M85x2.0	63.0	70.0	95	41	18	-	1000.85.700	1
M95x2.0	68.0	75.0	110	51	20	-	1000.95.750	1
M95x2.0	73.0	80.0	110	51	20	-	1000.95.800	1
M100x3.0	78.0	85.0	115	51	22	-	1000.100.850	1
M105x3.0	83.0	90.0	120	52	22	-	1000.105.900	1
M115x3.0	88.0	95.0	125	52	22	-	1000.115.950	1

1 = Metrisches Regelgewinde (mit VDE Testreport)

1 = Metric coarse-pitch thread (with VDE Testreport)

Erhältlich mit Dichteinsatz gemäss EN 45545 / NFPA 130.  
 Bei Anfragen oder Bestellung bitte ein F vor die Artikelnummer setzen.

Available with sealing inserts conformity with EN 45545 / NFPA 130. When placing an inquiry, prefix the article number by the capital F.

## Kurzes Anschlussgewinde metrisch | Short entry thread metric

Material: Messing vernickelt  
Dichtung: TPE  
O-Ring: NBR  
Zugentlastung: Ausführung A nach EN 62444  
Schutzart: IP 68 (bis 10 bar) / IP 69  
NEMA Type rating: 4X  
Einsatztemperatur: -40 °C / +100 °C

Material: Nickel-plated brass  
Seal: TPE  
O-ring: NBR  
Strain relief: Version A acc. to EN 62444  
Protection class: IP 68 (up to 10 bar) / IP 69  
NEMA Type rating: 4X  
Operation temperature: -40 °C / +100 °C

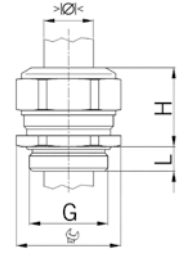

Zweiteiliger Dichteinsatz  
Nicht durchgehend isolierend

Two-piece sealing insert  
not overall length insulated

G	>Ø< min mm	>Ø< max mm	>Ø< min mm	>Ø< max mm	mm	H mm	L mm	Art.-No.	
M16x1.5	6.0	8.0	8.0	10.5	18	22	5	1000.17	50
M20x1.5	8.0	11.0	11.0	15.0	24	23	6	1000.20	50
M25x1.5	12.5	16.0	16.0	20.5	30	28	7	1000.25	25
M32x1.5	17.0	21.0	21.0	25.5	36	28	8	1000.32	25
M40x1.5	24.0	28.5	28.5	33.0	46	31	8	1000.40	10
M50x1.5	33.0	37.0	37.0	42.0	55	34	9	1000.50	10
M63x1.5	40.0	46.0	46.0	52.0	70	37	10	1000.63	5
M75x1.5	50.0	56.0	56.0	63.0	80	38	11	1000.75	1

Erhältlich mit Dichteinsatz gemäss EN 45545 / NFPA 130. Available with sealing inserts conformity with EN 45545 / NFPA 130. When placing an inquiry, prefix the article number by the capital F.



Progress MS



Einteiliger Dichteinsatz  
Durchgehend isolierend

One-piece sealing insert  
overall length insulated

G	>Ø< min mm	>Ø< max mm	mm	H mm	L mm	i info	Art.-No.	
M6x1.0	2.0	2.5	8	12	5	1	1060.06.025	50
M6x1.0	2.5	3.0	8	12	5	1	1060.06.030	50
M8x1.25	2.5	3.0	11	14	5	1	1060.08.030	50
M8x1.25	3.0	4.0	11	14	5	1	1060.08.040	50
M10x1.5	3.0	4.0	13	15	5	1	1060.10.040	50
M10x1.5	4.0	6.0	13	15	5	1	1060.10.060	50
M12x1.5	3.5	5.0	15	17	5	-	1060.12.050	50
M12x1.5	5.0	6.5	15	17	5	-	1060.12.065	50
M12x1.5	6.5	7.5	15	17	5	-	1060.12.075	50
M16x1.5	4.5	6.0	18	20	5	-	1060.17.060	50
M16x1.5	6.0	8.0	18	20	5	-	1060.17.080	50
M16x1.5	8.0	10.5	18	22	5	-	1060.17.105	50
M20x1.5	6.0	8.0	24	21	6	-	1060.20.080	50
M20x1.5	8.0	11.0	24	21	6	-	1060.20.110	50
M20x1.5	11.0	14.5	24	23	6	-	1060.20.145	50
M25x1.5	9.5	12.5	30	25	7	-	1060.25.125	25
M25x1.5	12.5	16.0	30	25	7	-	1060.25.160	25
M25x1.5	16.0	19.0	30	28	7	-	1060.25.190	25
M32x1.5	17.0	21.0	36	28	8	-	1060.32.210	25
M32x1.5	21.0	25.5	36	28	8	-	1060.32.255	25
M40x1.5	24.0	28.5	46	31	8	-	1060.40.285	10
M40x1.5	28.5	33.0	46	31	8	-	1060.40.330	10
M50x1.5	33.0	37.0	55	34	9	-	1060.50.370	10
M50x1.5	37.0	42.0	55	34	9	-	1060.50.420	10
M63x1.5	40.0	46.0	70	37	10	-	1060.63.460	5
M63x1.5	46.0	52.0	70	37	10	-	1060.63.520	5
M75x1.5	50.0	56.0	80	38	11	-	1060.75.560	1
M75x1.5	56.0	63.0	80	38	11	-	1060.75.630	1

1 = Metrisches Regelgewinde (mit VDE Testreport) 1 = Metric coarse-pitch thread (with VDE Testreport)

Erhältlich mit Dichteinsatz gemäss EN 45545 / NFPA 130. Available with sealing inserts conformity with EN 45545 / NFPA 130. When placing an inquiry, prefix the article number by the capital F.

1  
2  
3  
4  
5  
6  
7  
8  
9  
10  
11  
12  
13  
14  
15

# Kabelverschraubungen Progress® Messing Cable glands Progress® nickel-plated brass

## Kurzes Anschlussgewinde metrisch | Short entry thread metric

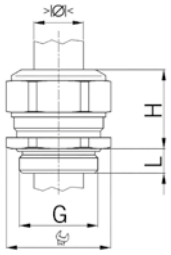

Material: Messing vernickelt  
 Dichtung: TPE  
 O-Ring: NBR  
 Zugentlastung: Ausführung A nach EN 62444  
 Schutzart: IP 68 (bis 10 bar) / IP 69  
 NEMA Type rating: 4X  
 Einsatztemperatur: -40 °C / +100 °C

Material: Nickel-plated brass  
 Seal: TPE  
 O-ring: NBR  
 Strain relief: Version A acc. to EN 62444  
 Protection class: IP 68 (up to 10 bar) / IP 69  
 NEMA Type rating: 4X  
 Operation temperature: -40 °C / +100 °C



Progress MS



Zweiteiliger Dichteinsatz  
Durchgehend isolierend

Two-piece sealing insert  
overall length insulated

G	>Ø < min mm	>Ø < max mm	>Ø < min mm	>Ø < max mm	Ø mm	H mm	L mm	Art.-No.	
M16x1.5	6.0	8.0	8.0	10.5	18	22	5	1060.17	50
M20x1.5	8.0	11.0	11.0	14.5	24	23	6	1060.20	50
M25x1.5	12.5	16.0	16.0	19.0	30	28	7	1060.25	25
M32x1.5	17.0	21.0	21.0	25.5	36	28	8	1060.32	25
M40x1.5	24.0	28.5	28.5	33.0	46	31	8	1060.40	10
M50x1.5	33.0	37.0	37.0	42.0	55	34	9	1060.50	10
M63x1.5	41.0	46.0	46.0	52.0	70	37	10	1060.63	5
M75x1.5	50.0	56.0	56.0	63.0	80	38	11	1060.75	1

Erhältlich mit Dichteinsatz gemäss EN 45545 / NFPA 130.  
Bei Anfragen oder Bestellung bitte ein F vor die Artikelnummer setzen.

Available with sealing inserts conformity with EN 45545 / NFPA 130. When placing an inquiry, prefix the article number by the capital F.

## Kurzes Anschlussgewinde metrisch | Short entry thread metric

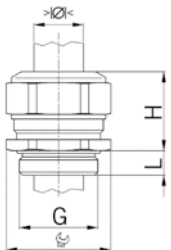

Material: Messing vernickelt  
 Dichtung: TPE  
 O-Ring: NBR  
 Schutzart: IP 68  
 Einsatztemperatur: -40 °C / +100 °C

Material: Nickel-plated brass  
 Seal: TPE  
 O-ring: NBR  
 Protection class: IP 68  
 Operation temperature: -40 °C / +100 °C



Einteiliger Dichteinsatz geschlitzt  
Nicht durchgehend isolierend

One-piece sealing insert, slotted  
not overall length insulated

G	>Ø < min mm	>Ø < max mm	ØPL mm	Ø mm	H mm	L mm	Art.-No.	
M20x1.5	3.0	4.5	15	24	21	6	1000.20.045G	50
M20x1.5	4.5	6.5	15	24	21	6	1000.20.065G	50
M20x1.5	6.0	8.0	15	24	21	6	1000.20.080G	50
M25x1.5	3.0	4.5	17	30	25	7	1000.25.045G	25
M25x1.5	4.5	6.5	17	30	25	7	1000.25.065G	25
M25x1.5	6.0	8.0	17	30	25	7	1000.25.080G	25
M32x1.5	3.0	4.5	25	36	28	8	1000.32.045G	25
M32x1.5	4.5	6.5	25	36	28	8	1000.32.065G	25
M32x1.5	6.0	8.0	25	36	28	8	1000.32.080G	25
M40x1.5	4.5	6.5	28	46	31	8	1000.40.065G	10
M40x1.5	6.0	8.0	28	46	31	8	1000.40.080G	10

### Langes Anschlussgewinde metrisch | Long entry thread metric

Material: Messing vernickelt  
 Dichtung: TPE  
 O-Ring: NBR  
 Zugentlastung: Ausführung A nach EN 62444  
 Schutzart: IP 68 (bis 10 bar) / IP 69  
 NEMA Type rating: 4X  
 Einsatztemperatur: -40 °C / +100 °C

Material: Nickel-plated brass  
 Seal: TPE  
 O-ring: NBR  
 Strain relief: Version A acc. to EN 62444  
 Protection class: IP 68 (up to 10 bar) / IP 69  
 NEMA Type rating: 4X  
 Operation temperature: -40 °C / +100 °C

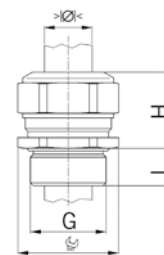

Einteiliger Dichteinsatz  
 Nicht durchgehend isolierend

One-piece sealing insert  
 not overall length insulated

G	$\varnothing_{\text{min}}$	$\varnothing_{\text{max}}$	$\varnothing_{\text{mm}}$	H	L	i	Art.-No.	
	min mm	max mm	mm	mm	mm	info		
M6x1.0	2.0	2.5	8	12	8	1	1100.06.025	50
M6x1.0	2.5	3.0	8	12	8	1	1100.06.030	50
M6x1.0	3.0	3.5	8	12	8	1	1100.06.035	50
M8x1.25	2.5	3.5	11	14	10	1	1100.08.035	50
M8x1.25	3.5	5.0	11	14	10	1	1100.08.050	50
M10x1.5	3.0	4.0	13	15	10	1	1100.10.040	50
M10x1.5	4.0	6.0	13	15	10	1	1100.10.060	50
M12x1.5	3.5	5.0	15	17	10	-	1100.12.050	50
M12x1.5	5.0	6.5	15	17	10	-	1100.12.065	50
M12x1.5	6.5	8.0	15	17	10	-	1100.12.080	50
M16x1.5	3.5	4.5	18	20	10	-	1100.17.045	50
M16x1.5	4.5	6.0	18	20	10	-	1100.17.060	50
M16x1.5	6.0	8.0	18	20	10	-	1100.17.080	50
M16x1.5	8.0	10.5	18	22	10	-	1100.17.105	50
M20x1.5	6.0	8.0	24	21	10	-	1100.20.080	50
M20x1.5	8.0	11.0	24	21	10	-	1100.20.110	50
M20x1.5	11.0	15.0	24	23	10	-	1100.20.150	50
M25x1.5	9.5	12.5	30	25	11	-	1100.25.125	25
M25x1.5	12.5	16.0	30	27	11	-	1100.25.160	25
M25x1.5	16.0	20.5	30	28	11	-	1100.25.205	25
M32x1.5	14.0	17.0	36	28	13	-	1100.32.170	25
M32x1.5	17.0	21.0	36	28	13	-	1100.32.210	25
M32x1.5	21.0	25.5	36	28	13	-	1100.32.255	25
M40x1.5	20.0	24.0	46	31	13	-	1100.40.240	10
M40x1.5	24.0	28.5	46	31	13	-	1100.40.285	10
M40x1.5	28.5	33.0	46	31	13	-	1100.40.330	10
M50x1.5	29.0	33.0	55	34	14	-	1100.50.330	10
M50x1.5	33.0	37.0	55	34	14	-	1100.50.370	10
M50x1.5	37.0	42.0	55	34	14	-	1100.50.420	10
M63x1.5	35.0	40.0	70	37	14	-	1100.63.400	5
M63x1.5	40.0	46.0	70	37	14	-	1100.63.460	5
M63x1.5	46.0	52.0	70	37	14	-	1100.63.520	5
M75x1.5	45.0	50.0	80	38	15	-	1100.75.500	1
M75x1.5	50.0	56.0	80	38	15	-	1100.75.560	1
M75x1.5	56.0	63.0	80	38	15	-	1100.75.630	1

1 = Metrisches Regelgewinde (mit VDE Testreport)

1 = Metric coarse-pitch thread (with VDE Testreport)

Erhältlich mit Dichteinsatz gemäss EN 45545 / NFPA 130. Bei Anfragen oder Bestellung bitte ein F vor die Artikelnummer setzen.

Available with sealing inserts conformity with EN 45545 / NFPA 130. When placing an inquiry, prefix the article number by the capital F.



Progress MS



# Kabelverschraubungen Progress® Messing

## Cable glands Progress® nickel-plated brass

### Langes Anschlussgewinde metrisch | Long entry thread metric

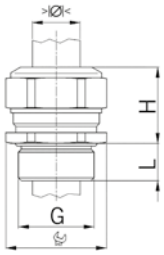

Material: Messing vernickelt  
 Dichtung: TPE  
 O-Ring: NBR  
 Zugentlastung: Ausführung A nach EN 62444  
 Schutzart: IP 68 (bis 10 bar) / IP 69  
 NEMA Type rating: 4X  
 Einsatztemperatur: -40 °C / +100 °C

Material: Nickel-plated brass  
 Seal: TPE  
 O-ring: NBR  
 Strain relief: Version A acc. to EN 62444  
 Protection class: IP 68 (up to 10 bar) / IP 69  
 NEMA Type rating: 4X  
 Operation temperature: -40 °C / +100 °C



Zweiteiliger Dichteinsatz  
 Nicht durchgehend isolierend

Two-piece sealing insert  
 not overall length insulated

G	>Ø< min mm	>Ø< max mm	>Ø< min mm	>Ø< max mm	Ø mm	H mm	L mm	Art.-No.	
M16x1.5	6.0	8.0	8.0	10.5	18	22	10	1100.17	50
M20x1.5	8.0	11.0	11.0	15.0	24	23	10	1100.20	50
M25x1.5	12.5	16.0	16.0	20.5	30	28	11	1100.25	25
M32x1.5	17.0	21.0	21.0	25.5	36	28	13	1100.32	25
M40x1.5	24.0	28.5	28.5	33.0	46	31	13	1100.40	10
M50x1.5	33.0	37.0	37.0	42.0	55	34	14	1100.50	10
M63x1.5	40.0	46.0	46.0	52.0	70	37	14	1100.63	5
M75x1.5	50.0	56.0	56.0	63.0	80	38	15	1100.75	1

Erhältlich mit Dichteinsatz gemäss EN 45545 / NFPA 130. Available with sealing inserts conformity with EN 45545 / NFPA 130. When placing an inquiry, prefix the article number by the capital F.

Progress MS



### Langes Anschlussgewinde metrisch | Long entry thread metric

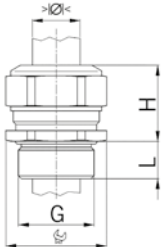

Material: Messing vernickelt  
 Dichtung: TPE  
 O-Ring: NBR  
 Schutzart: IP 68  
 Einsatztemperatur: -40 °C / +100 °C

Material: Nickel-plated brass  
 Seal: TPE  
 O-ring: NBR  
 Protection class: IP 68  
 Operation temperature: -40 °C / +100 °C



Einteiliger Dichteinsatz geschlitzt  
 Nicht durchgehend isolierend

One-piece sealing insert, slotted  
 not overall length insulated

G	>Ø< min mm	>Ø< max mm	Ø PL mm	Ø mm	H mm	L mm	Art.-No.	
M20x1.5	3.0	4.5	15	24	21	10	1100.20.045G	50
M20x1.5	4.5	6.5	15	24	21	10	1100.20.065G	50
M20x1.5	6.0	8.0	15	24	21	10	1100.20.080G	50
M25x1.5	3.0	4.5	17	30	25	11	1100.25.045G	25
M25x1.5	4.5	6.5	17	30	25	11	1100.25.065G	25
M25x1.5	6.0	8.0	17	30	25	11	1100.25.080G	25
M32x1.5	3.0	4.5	25	36	28	13	1100.32.045G	25
M32x1.5	4.5	6.5	25	36	28	13	1100.32.065G	25
M32x1.5	6.0	8.0	25	36	28	13	1100.32.080G	25
M40x1.5	4.5	6.5	28	46	31	13	1100.40.065G	10
M40x1.5	6.0	8.0	28	46	31	13	1100.40.080G	10

### Langes Anschlussgewinde metrisch | Long entry thread metric

Material: Messing vernickelt  
 Dichtung: TPE  
 O-Ring: NBR  
 Zugentlastung: Ausführung A nach EN 62444  
 Schutzart: IP 68 (bis 10 bar) / IP 69  
 NEMA Type rating: 4X  
 Einsatztemperatur: -40 °C / +100 °C

Material: Nickel-plated brass  
 Seal: TPE  
 O-ring: NBR  
 Strain relief: Version A acc. to EN 62444  
 Protection class: IP 68 (up to 10 bar) / IP 69  
 NEMA Type rating: 4X  
 Operation temperature: -40 °C / +100 °C

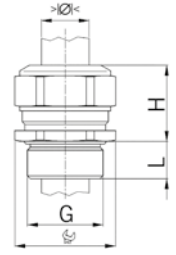

Einteiliger Dichteinsatz  
 Durchgehend isolierend

One-piece sealing insert  
 overall length insulated

G	$\begin{matrix} >D_1< \\ \text{min mm} \end{matrix}$	$\begin{matrix} >D_1< \\ \text{max mm} \end{matrix}$	$\begin{matrix} \text{mm} \\ \text{mm} \end{matrix}$	H	L	i	Art.-No.	
M6x1.0	2.0	2.5	8	12	8	1	1160.06.025	50
M6x1.0	2.5	3.0	8	12	8	1	1160.06.030	50
M8x1.25	2.5	3.0	11	14	10	1	1160.08.030	50
M8x1.25	3.0	4.0	11	14	10	1	1160.08.040	50
M10x1.5	3.0	4.0	13	15	10	1	1160.10.040	50
M10x1.5	4.0	6.0	13	15	10	1	1160.10.060	50
M12x1.5	3.5	5.0	15	17	10	-	1160.12.050	50
M12x1.5	5.0	6.5	15	17	10	-	1160.12.065	50
M12x1.5	6.5	7.5	15	17	10	-	1160.12.075	50
M16x1.5	8.0	10.5	18	22	10	-	1160.17.105	50
M20x1.5	11.0	14.5	24	23	10	-	1160.20.145	50
M25x1.5	16.0	19.0	30	28	11	-	1160.25.190	25
M32x1.5	21.0	25.5	36	28	13	-	1160.32.255	25
M40x1.5	28.5	33.0	46	34	13	-	1160.40.330	10
M50x1.5	37.0	42.0	55	34	14	-	1160.50.420	10
M63x1.5	46.0	52.0	70	37	14	-	1160.63.520	5
M75x1.5	56.0	63.0	80	38	15	-	1160.75.630	1



Progress MS



1 = Metrisches Regelgewinde (mit VDE Testreport)

1 = Metric coarse-pitch thread (with VDE Testreport)

Erhältlich mit Dichteinsatz gemäss EN 45545 / NFPA 130. Bei Anfragen oder Bestellung bitte ein F vor die Artikelnummer setzen.

Available with sealing inserts conformity with EN 45545 / NFPA 130. When placing an inquiry, prefix the article number by the capital F.

Zweiteiliger Dichteinsatz  
 Durchgehend isolierend

Two-piece sealing insert  
 overall length insulated

G	$\begin{matrix} >D_1< \\ \text{min mm} \end{matrix}$	$\begin{matrix} >D_1< \\ \text{max mm} \end{matrix}$	$\begin{matrix} >D_1< \\ \text{min mm} \end{matrix}$	$\begin{matrix} >D_1< \\ \text{max mm} \end{matrix}$	$\begin{matrix} \text{mm} \\ \text{mm} \end{matrix}$	H	L	Art.-No.	
M16x1.5	6.0	8.0	8.0	10.5	18	22	10	1160.17	50
M20x1.5	8.0	11.0	11.0	14.5	24	23	10	1160.20	50
M25x1.5	12.5	16.0	16.0	19.0	30	28	11	1160.25	25
M32x1.5	17.0	21.0	21.0	25.5	36	28	13	1160.32	25
M40x1.5	24.0	28.5	28.5	33.0	46	31	13	1160.40	10
M50x1.5	33.0	37.0	37.0	42.0	55	34	14	1160.50	10
M63x1.5	41.0	46.0	46.0	52.0	70	37	14	1160.63	5
M75x1.5	50.0	56.0	56.0	63.0	80	38	15	1160.75	1

Erhältlich mit Dichteinsatz gemäss EN 45545 / NFPA 130. Bei Anfragen oder Bestellung bitte ein F vor die Artikelnummer setzen.

Available with sealing inserts conformity with EN 45545 / NFPA 130. When placing an inquiry, prefix the article number by the capital F.

1  
2  
3  
4  
5  
6  
7  
8  
9  
10  
11  
12  
13  
14  
15

# Kabelverschraubungen Progress® Messing

## Cable glands Progress® nickel-plated brass

### Kurzes Anschlussgewinde Pg | Short entry thread Pg

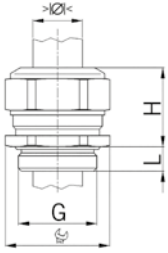

Material: Messing vernickelt  
 Dichtung: TPE  
 O-Ring: NBR  
 Schutzart: IP 68 (bis 10 bar) / IP 69  
 NEMA Type rating: 4X  
 Einsatztemperatur: -40 °C / +100 °C

Material: Nickel-plated brass  
 Seal: TPE  
 O-ring: NBR  
 Protection class: IP 68 (up to 10 bar) / IP 69  
 NEMA Type rating: 4X  
 Operation temperature: -40 °C / +100 °C



Progress MS



Einteiliger Dichteinsatz  
 Nicht durchgehend isolierend

One-piece sealing insert  
 not overall length insulated

G	>math>D_1</math> min mm	>math>D_1</math> max mm	>math>D_2</math> mm	H mm	L mm	Art.-No.	
Pg 7	3.5	5.0	15	17	6.0	1000.07.050	50
Pg 7	5.0	6.5	15	17	6.0	1000.07.065	50
Pg 7	6.5	8.0	15	17	6.0	1000.07.080	50
Pg 9	3.5	4.5	18	20	6.0	1000.09.045	50
Pg 9	4.5	6.0	18	20	6.0	1000.09.060	50
Pg 9	6.0	8.0	18	20	6.0	1000.09.080	50
Pg 9	8.0	10.5	18	22	6.0	1000.09.105	50
Pg 11	4.0	5.5	21	21	6.0	1000.11.055	50
Pg 11	5.5	8.5	21	21	6.0	1000.11.085	50
Pg 11	8.5	12.0	21	21	6.0	1000.11.120	50
Pg 13	6.0	8.0	24	21	6.0	1000.13.080	50
Pg 13	8.0	11.0	24	21	6.0	1000.13.110	50
Pg 13	11.0	15.0	24	23	6.0	1000.13.150	50
Pg 16	6.0	8.0	24	23	6.0	1000.16.080	50
Pg 16	8.0	11.0	24	23	6.0	1000.16.110	50
Pg 16	11.0	15.0	24	23	6.0	1000.16.150	50
Pg 21	9.5	12.5	30	28	7.5	1000.21.125	25
Pg 21	12.5	16.0	30	28	7.5	1000.21.160	25
Pg 21	16.0	20.5	30	28	7.5	1000.21.205	25
Pg 29	16.0	19.0	38	28	8.0	1000.29.190	25
Pg 29	19.0	23.0	38	28	8.0	1000.29.230	25
Pg 29	23.0	27.5	38	28	8.0	1000.29.275	25
Pg 36	21.5	26.0	50	32	8.0	1000.36.260	10
Pg 36	26.0	30.5	50	32	8.0	1000.36.305	10
Pg 36	30.5	35.0	50	32	8.0	1000.36.350	10
Pg 42	29.0	33.0	55	34	10.0	1000.42.330	10
Pg 42	33.0	37.0	55	34	10.0	1000.42.370	10
Pg 42	37.0	42.0	55	34	10.0	1000.42.420	10
Pg 48	32.0	37.0	65	37	11.0	1000.48.370	10
Pg 48	37.0	43.0	65	37	11.0	1000.48.430	5
Pg 48	43.0	49.0	65	37	11.0	1000.48.490	10

Erhältlich mit Dichteinsatz gemäss EN 45545 / NFPA 130.  
 Bei Anfragen oder Bestellung bitte ein F vor die Artikelnummer setzen.

Available with sealing inserts conformity with EN 45545 / NFPA 130. When placing an inquiry, prefix the article number by the capital F.

## Kurzes Anschlussgewinde Pg | Short entry thread Pg

Material: Messing vernickelt  
Dichtung: TPE  
O-Ring: NBR  
Schutzart: IP 68 (bis 10 bar) / IP 69  
NEMA Type rating: 4X  
Einsatztemperatur: -40 °C / +100 °C

Material: Nickel-plated brass  
Seal: TPE  
O-ring: NBR  
Protection class: IP 68 (up to 10 bar) / IP 69  
NEMA Type rating: 4X  
Operation temperature: -40 °C / +100 °C

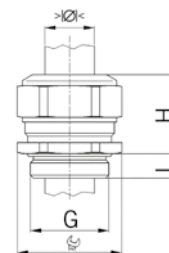

Zweiteiliger Dichteinsatz  
Nicht durchgehend isolierend

Two-piece sealing insert  
not overall length insulated

G	Ø		Ø		H	L	Art.-No.	📦
	min mm	max mm	min mm	max mm				
<b>Pg 9</b>	6.0	8.0	8.0	10.5	18	22	<b>1000.09</b>	50
<b>Pg 11</b>	5.5	8.5	8.5	12.0	21	21	<b>1000.11</b>	50
<b>Pg 13</b>	8.0	11.0	11.0	15.0	24	23	<b>1000.13</b>	50
<b>Pg 16</b>	8.0	11.0	11.0	15.0	24	23	<b>1000.16</b>	50
<b>Pg 21</b>	12.5	16.0	16.0	20.5	30	28	<b>1000.21</b>	25
<b>Pg 29</b>	19.0	23.0	23.0	27.5	38	28	<b>1000.29</b>	25
<b>Pg 36</b>	26.0	30.5	30.5	35.0	50	32	<b>1000.36</b>	10
<b>Pg 42</b>	33.0	37.0	37.0	42.0	55	34	<b>1000.42</b>	10
<b>Pg 48</b>	37.0	43.0	43.0	49.0	65	37	<b>1000.48</b>	10

Erhältlich mit Dichteinsatz gemäss EN 45545 / NFPA 130.  
Bei Anfragen oder Bestellung bitte ein F vor die Artikelnummer setzen.

Available with sealing inserts conformity with EN 45545 / NFPA 130. When placing an inquiry, prefix the article number by the capital F.



Progress MS



# Kabelverschraubungen Progress® Messing

## Cable glands Progress® nickel-plated brass

### Kurzes Anschlussgewinde Pg | Short entry thread Pg

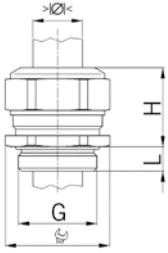

Material: Messing vernickelt  
 Dichtung: TPE  
 O-Ring: NBR  
 Schutzart: IP 68 (bis 10 bar) / IP 69  
 NEMA Type rating: 4X  
 Einsatztemperatur: -40 °C / +100 °C

Material: Nickel-plated brass  
 Seal: TPE  
 O-ring: NBR  
 Protection class: IP 68 (up to 10 bar) / IP 69  
 NEMA Type rating: 4X  
 Operation temperature: -40 °C / +100 °C



Progress MS



Einteiliger Dichteinsatz  
 Durchgehend isolierend

One-piece sealing insert  
 overall length insulated

G	>math>D_1</math> min mm	>math>D_1</math> max mm	>math>D_2</math> mm	H mm	L mm	Art.-No.	
Pg 7	3.5	5.0	15	17	6.0	1060.07.050	50
Pg 7	5.0	6.5	15	17	6.0	1060.07.065	50
Pg 7	6.5	7.5	15	17	6.0	1060.07.075	50
Pg 9	4.5	6.0	18	20	6.0	1060.09.060	50
Pg 9	6.0	8.0	18	20	6.0	1060.09.080	50
Pg 9	8.0	10.5	18	22	6.0	1060.09.105	50
Pg 11	4.0	5.5	21	21	6.0	1060.11.055	50
Pg 11	5.5	8.5	21	21	6.0	1060.11.085	50
Pg 11	8.5	12.0	21	21	6.0	1060.11.120	50
Pg 13	6.0	8.0	24	21	6.0	1060.13.080	50
Pg 13	8.0	11.0	24	21	6.0	1060.13.110	50
Pg 13	11.0	14.5	24	23	6.0	1060.13.145	50
Pg 16	6.0	8.0	24	23	6.0	1060.16.080	50
Pg 16	8.0	11.0	24	23	6.0	1060.16.110	50
Pg 16	11.0	14.5	24	23	6.0	1060.16.145	50
Pg 21	9.5	12.5	30	28	7.5	1060.21.125	25
Pg 21	12.5	16.0	30	28	7.5	1060.21.160	25
Pg 21	16.0	19.0	30	28	7.5	1060.21.190	25
Pg 29	19.0	23.0	38	28	8.0	1060.29.230	25
Pg 29	23.0	27.5	38	28	8.0	1060.29.275	25
Pg 36	26.0	30.5	50	32	8.0	1060.36.305	10
Pg 36	30.5	35.0	50	32	8.0	1060.36.350	10
Pg 42	33.0	37.0	55	34	10.0	1060.42.370	10
Pg 42	37.0	42.0	55	34	10.0	1060.42.420	10
Pg 48	37.0	43.0	65	37	11.0	1060.48.430	10
Pg 48	43.0	49.0	65	37	11.0	1060.48.490	10

Erhältlich mit Dichteinsatz gemäss EN 45545 / NFPA 130. Available with sealing inserts conformity with EN 45545 / NFPA 130. Bei Anfragen oder Bestellung bitte ein F vor die Artikelnummer setzen. When placing an inquiry, prefix the article number by the capital F.

Zweiteiliger Dichteinsatz  
 Durchgehend isolierend

Two-piece sealing insert  
 overall length insulated

G	>math>D_1</math> min mm	>math>D_1</math> max mm	>math>D_2</math> min mm	>math>D_2</math> max mm	H mm	L mm	Art.-No.	
Pg 9	6.0	8.0	8.0	10.5	18	22	1060.09	50
Pg 11	5.5	8.5	8.5	12.0	21	21	1060.11	50
Pg 13	8.0	11.0	11.0	14.5	24	23	1060.13	50
Pg 16	8.0	11.0	11.0	14.5	24	23	1060.16	50
Pg 21	12.5	16.0	16.0	19.0	30	28	1060.21	25
Pg 29	19.0	23.0	23.0	27.5	38	28	1060.29	25
Pg 36	26.0	30.5	30.5	35.0	50	32	1060.36	10
Pg 42	33.0	37.0	37.0	42.0	55	34	1060.42	10
Pg 48	37.0	43.0	43.0	49.0	65	37	1060.48	10

Erhältlich mit Dichteinsatz gemäss EN 45545 / NFPA 130. Available with sealing inserts conformity with EN 45545 / NFPA 130. Bei Anfragen oder Bestellung bitte ein F vor die Artikelnummer setzen. When placing an inquiry, prefix the article number by the capital F.

## Langes Anschlussgewinde Pg | Long entry thread Pg

Material: Messing vernickelt  
Dichtung: TPE  
O-Ring: NBR  
Schutzart: IP 68 (bis 10 bar) / IP 69  
NEMA Type rating: 4X  
Einsatztemperatur: -40 °C / +100 °C

Material: Nickel-plated brass  
Seal: TPE  
O-ring: NBR  
Protection class: IP 68 (up to 10 bar) / IP 69  
NEMA Type rating: 4X  
Operation temperature: -40 °C / +100 °C

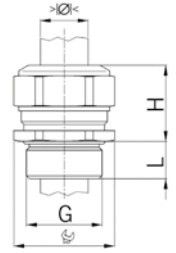

Einteiliger Dichteinsatz  
Nicht durchgehend isolierend

One-piece sealing insert  
not overall length insulated

G	>Ø< min mm	>Ø< max mm	Ø mm	H mm	L mm	Art.-No.	
Pg 7	3.5	5.0	15	17	10	1100.07.050	50
Pg 7	5.0	6.5	15	17	10	1100.07.065	50
Pg 7	6.5	8.0	15	17	10	1100.07.080	50
Pg 9	3.5	4.5	18	20	10	1100.09.045	50
Pg 9	4.5	6.0	18	20	10	1100.09.060	50
Pg 9	6.0	8.0	18	20	10	1100.09.080	50
Pg 9	8.0	10.5	18	22	10	1100.09.105	50
Pg 11	4.0	5.5	21	21	10	1100.11.055	50
Pg 11	5.5	8.5	21	21	10	1100.11.085	50
Pg 11	8.5	12.0	21	21	10	1100.11.120	50
Pg 13	6.0	8.0	24	21	10	1100.13.080	50
Pg 13	8.0	11.0	24	21	10	1100.13.110	50
Pg 13	11.0	15.0	24	23	10	1100.13.150	50
Pg 16	6.0	8.0	24	23	10	1100.16.080	50
Pg 16	8.0	11.0	24	23	10	1100.16.110	50
Pg 16	11.0	15.0	24	23	10	1100.16.150	50
Pg 21	9.5	12.5	30	28	12	1100.21.125	25
Pg 21	12.5	16.0	30	28	12	1100.21.160	25
Pg 21	16.0	20.5	30	28	12	1100.21.205	25
Pg 29	16.0	19.0	38	28	12	1100.29.190	25
Pg 29	19.0	23.0	38	28	12	1100.29.230	25
Pg 29	23.0	27.5	38	28	12	1100.29.275	25
Pg 36	21.5	26.0	50	32	15	1100.36.260	10
Pg 36	26.0	30.5	50	32	15	1100.36.305	10
Pg 36	30.5	35.0	50	32	15	1100.36.350	10
Pg 42	29.0	33.0	55	34	15	1100.42.330	10
Pg 42	33.0	37.0	55	34	15	1100.42.370	10
Pg 42	37.0	42.0	55	34	15	1100.42.420	10
Pg 48	32.0	37.0	65	37	15	1100.48.370	10
Pg 48	37.0	43.0	65	37	15	1100.48.430	10
Pg 48	43.0	49.0	65	37	15	1100.48.490	10

Erhältlich mit Dichteinsatz gemäss EN 45545 / NFPA 130.  
Bei Anfragen oder Bestellung bitte ein F vor die Artikelnummer setzen.

Available with sealing inserts conformity with EN 45545 / NFPA 130. When placing an inquiry, prefix the article number by the capital F.



Progress MS



# Kabelverschraubungen Progress® Messing

## Cable glands Progress® nickel-plated brass

### Langes Anschlussgewinde Pg | Long entry thread Pg

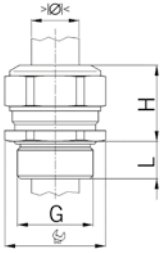

Material: Messing vernickelt  
 Dichtung: TPE  
 O-Ring: NBR  
 Schutzart: IP 68 (bis 10 bar) / IP 69  
 NEMA Type rating: 4X  
 Einsatztemperatur: -40 °C / +100 °C

Material: Nickel-plated brass  
 Seal: TPE  
 O-ring: NBR  
 Protection class: IP 68 (up to 10 bar) / IP 69  
 NEMA Type rating: 4X  
 Operation temperature: -40 °C / +100 °C



Progress MS



Zweiteiliger Dichteinsatz  
 Nicht durchgehend isolierend

Two-piece sealing insert  
 not overall length insulated

G	>Ø<		>Ø<		mm	H	L	Art.-No.	
	min mm	max mm	min mm	max mm					
<b>Pg 9</b>	6.0	8.0	8.0	10.5	18	22	10	<b>1100.09</b>	50
<b>Pg 11</b>	5.5	8.5	8.5	12.0	21	21	10	<b>1100.11</b>	50
<b>Pg 13</b>	8.0	11.0	11.0	15.0	24	23	10	<b>1100.13</b>	50
<b>Pg 16</b>	8.0	11.0	11.0	15.0	24	23	10	<b>1100.16</b>	50
<b>Pg 21</b>	12.5	16.0	16.0	20.5	30	28	12	<b>1100.21</b>	25
<b>Pg 29</b>	19.0	23.0	23.0	27.5	38	28	12	<b>1100.29</b>	25
<b>Pg 36</b>	26.0	30.5	30.5	35.0	50	32	15	<b>1100.36</b>	10
<b>Pg 42</b>	33.0	37.0	37.0	42.0	55	34	15	<b>1100.42</b>	10
<b>Pg 48</b>	37.0	43.0	43.0	49.0	65	37	15	<b>1100.48</b>	10

Erhältlich mit Dichteinsatz gemäss EN 45545 / NFPA 130.  
 Bei Anfragen oder Bestellung bitte ein F vor die Artikelnummer setzen.

Available with sealing inserts conformity with EN 45545 / NFPA 130. When placing an inquiry, prefix the article number by the capital F.

## Langes Anschlussgewinde Pg | Long entry thread Pg

Material: Messing vernickelt  
Dichtung: TPE  
O-Ring: NBR  
Schutzart: IP 68 (bis 10 bar) / IP 69  
NEMA Type rating: 4X  
Einsatztemperatur: -40 °C / +100 °C

Material: Nickel-plated brass  
Seal: TPE  
O-ring: NBR  
Protection class: IP 68 (up to 10 bar) / IP 69  
NEMA Type rating: 4X  
Operation temperature: -40 °C / +100 °C

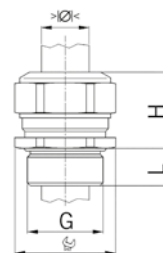

Einteiliger Dichteinsatz  
Durchgehend isolierend

One-piece sealing insert  
overall length insulated

G	$\begin{matrix} > \text{Ø} < \\ \text{min mm} \end{matrix}$	$\begin{matrix} > \text{Ø} < \\ \text{max mm} \end{matrix}$	$\begin{matrix} > \text{Ø} < \\ \text{mm} \end{matrix}$	$\begin{matrix} > \text{Ø} < \\ \text{max mm} \end{matrix}$	$\begin{matrix} \text{H} \\ \text{mm} \end{matrix}$	$\begin{matrix} \text{L} \\ \text{mm} \end{matrix}$	Art.-No.	
Pg 7	5.0	6.5	15	17	10	1160.07.065	50	
Pg 7	6.5	7.5	15	17	10	1160.07.075	50	
Pg 9	8.0	10.5	18	22	10	1160.09.105	50	
Pg 11	8.5	12.0	21	21	10	1160.11.120	50	
Pg 13	11.0	14.5	24	23	10	1160.13.145	50	
Pg 16	11.0	14.5	24	23	10	1160.16.145	50	
Pg 21	16.0	19.0	30	28	12	1160.21.190	25	
Pg 29	23.0	27.5	38	28	12	1160.29.275	25	
Pg 36	30.5	35.0	50	32	15	1160.36.350	10	
Pg 42	37.0	42.0	55	32	15	1160.42.420	10	
Pg 48	43.0	49.0	65	37	15	1160.48.490	10	

Erhältlich mit Dichteinsatz gemäss EN 45545 / NFPA 130. Bei Anfragen oder Bestellung bitte ein F vor die Artikelnummer setzen.

Available with sealing inserts conformity with EN 45545 / NFPA 130. When placing an inquiry, prefix the article number by the capital F.



Progress MS



Zweiteiliger Dichteinsatz  
Durchgehend isolierend

Two-piece sealing insert  
overall length insulated

G	$\begin{matrix} > \text{Ø} < \\ \text{min mm} \end{matrix}$	$\begin{matrix} > \text{Ø} < \\ \text{max mm} \end{matrix}$	$\begin{matrix} > \text{Ø} < \\ \text{min mm} \end{matrix}$	$\begin{matrix} > \text{Ø} < \\ \text{max mm} \end{matrix}$	$\begin{matrix} \text{H} \\ \text{mm} \end{matrix}$	$\begin{matrix} \text{L} \\ \text{mm} \end{matrix}$	Art.-No.	
Pg 9	6.0	8.0	8.0	10.5	18	22	1160.09	50
Pg 11	5.5	8.5	8.5	12.0	21	21	1160.11	50
Pg 13	8.0	11.0	11.0	14.5	24	23	1160.13	50
Pg 16	8.0	11.0	11.0	14.5	24	23	1160.16	50
Pg 21	12.5	16.0	16.0	19.0	30	28	1160.21	25
Pg 29	19.0	23.0	23.0	27.5	38	28	1160.29	25
Pg 36	26.0	30.5	30.5	35.0	50	32	1160.36	10
Pg 42	33.0	37.0	37.0	42.0	55	34	1160.42	10
Pg 48	37.0	43.0	43.0	49.0	65	37	1160.48	10

Erhältlich mit Dichteinsatz gemäss EN 45545 / NFPA 130. Bei Anfragen oder Bestellung bitte ein F vor die Artikelnummer setzen.

Available with sealing inserts conformity with EN 45545 / NFPA 130. When placing an inquiry, prefix the article number by the capital F.

# Kabelverschraubungen Progress® Messing

## Cable glands Progress® nickel-plated brass

### Anschlussgewinde NPT | Entry thread NPT

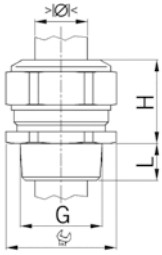

Material: Messing vernickelt  
 Dichtung: TPE  
 Schutzart: IP 68 (bis 10 bar) / IP 69  
 Gewinde: IP 68, wenn Anschlussgewinde abgedichtet  
 NEMA Type rating: 4X  
 Einsatztemperatur: -40 °C / +100 °C

Material: Nickel-plated brass  
 Seal: TPE  
 Protection class: IP 68 (up to 10 bar) / IP 69  
 Entry thread: IP 68, if the entry thread is sealed  
 NEMA Type rating: 4X  
 Operation temperature: -40 °C / +100 °C



Progress MS NPT



Einteiliger Dichteinsatz  
 Nicht durchgehend isolierend

One-piece sealing insert  
 not overall length insulated

G	>Ø< min mm	>Ø< max mm	mm	H mm	L mm	Art.-No.	
NPT 1/8"	3.0	4.0	13	15	8	1000.1/8NPT.040	50
NPT 1/8"	4.0	6.0	13	15	8	1000.1/8NPT.060	50
NPT 1/4"	3.5	5.0	15	17	12	1000.1/4NPT.050	50
NPT 1/4"	5.0	6.5	15	17	12	1000.1/4NPT.065	50
NPT 1/4"	6.5	8.0	15	17	12	1000.1/4NPT.080	50
NPT 3/8"	3.5	4.5	18	20	12	1000.3/8NPT.045	50
NPT 3/8"	4.5	6.0	18	20	12	1000.3/8NPT.060	50
NPT 3/8"	6.0	8.0	18	20	12	1000.3/8NPT.080	50
NPT 3/8"	8.0	10.5	18	22	12	1000.3/8NPT.105	50
NPT 1/2"	6.0	8.0	24	21	15	1000.1/2NPT.080	50
NPT 1/2"	8.0	11.0	24	21	15	1000.1/2NPT.110	50
NPT 1/2"	11.0	15.0	24	23	15	1000.1/2NPT.150	50
NPT 3/4"	9.5	12.5	30	28	15	1000.3/4NPT.125	25
NPT 3/4"	12.5	16.0	30	28	15	1000.3/4NPT.160	25
NPT 3/4"	16.0	20.5	30	28	15	1000.3/4NPT.205	25
NPT 1"	14.0	17.0	36	28	20	1000.1NPT.170	25
NPT 1"	17.0	21.0	36	28	20	1000.1NPT.210	25
NPT 1"	21.0	25.5	36	28	20	1000.1NPT.255	25
NPT 1 1/4"	20.0	24.0	46	31	20	1000.11/4NPT.240	10
NPT 1 1/4"	24.0	28.5	46	31	20	1000.11/4NPT.285	10
NPT 1 1/4"	28.5	33.0	46	31	20	1000.11/4NPT.330	10
NPT 1 1/2"	29.0	33.0	55	34	22	1000.11/2NPT.330	10
NPT 1 1/2"	33.0	37.0	55	34	22	1000.11/2NPT.370	10
NPT 1 1/2"	37.0	41.0	55	34	22	1000.11/2NPT.410	10
NPT 2"	35.0	40.0	70	37	22	1000.2NPT.400	5
NPT 2"	40.0	46.0	70	37	22	1000.2NPT.460	5
NPT 2"	46.0	52.0	70	37	22	1000.2NPT.520	5

Zweiteiliger Dichteinsatz  
 Nicht durchgehend isolierend

Two-piece sealing insert  
 not overall length insulated

G	>Ø< min mm	>Ø< max mm	>Ø< min mm	>Ø< max mm	mm	H mm	L mm	Art.-No.	
NPT 3/8"	6.0	8.0	8.0	10.5	18	22	12	1000.3/8NPT	50
NPT 1/2"	8.0	11.0	11.0	15.0	24	23	15	1000.1/2NPT	50
NPT 3/4"	12.5	16.0	16.0	20.5	30	28	15	1000.3/4NPT	25
NPT 1"	17.0	21.0	21.0	25.5	36	28	20	1000.1NPT	25
NPT 1 1/4"	24.0	28.5	28.5	33.0	46	31	20	1000.11/4NPT	10
NPT 1 1/2"	33.0	37.0	37.0	41.0	55	34	22	1000.11/2NPT	10
NPT 2"	40.0	46.0	46.0	52.0	70	37	22	1000.2NPT	5

## Anschlussgewinde Gasrohr | Gas-pipe entry thread

Material: Messing vernickelt  
Dichtung: TPE  
O-Ring: NBR  
Schutzart: IP 68  
Einsatztemperatur: -40 °C / +100 °C

Material: Nickel-plated brass  
Seal: TPE  
O-ring: NBR  
Protection class: IP 68  
Operation temperature: -40 °C / +100 °C

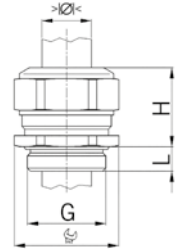

Zweiteiliger Dichteinsatz  
Nicht durchgehend isolierend

Two-piece sealing insert  
not overall length insulated

G	>Ø< min mm	>Ø< max mm	>Ø< min mm	>Ø< max mm	Ø mm	H mm	L mm	i info	Art.-No.	
G 3/8"	5.5	8.5	8.5	12.0	21	21	6	-	1000.3/8G	50
G 1/2"	8.0	11.0	11.0	15.0	24	23	8	-	1000.1/2G	50
G 3/4"	12.5	16.0	16.0	20.5	30	28	10	-	1000.3/4G	25
G 1"	17.0	21.0	21.0	25.5	36	28	11	-	1000.1G	25
G 1 1/2"	25.0	30.5	30.5	35.0	55/50	32	12	-	1000.11/2G	10
G 2"	37.0	43.0	43.0	49.0	65	37	12	-	1000.2G	10
G 2 1/2"	-	-	45.0	50.0	80	38	18	1	1000.21/2G.500	1
G 2 1/2"	-	-	50.0	56.0	80	38	18	1	1000.21/2G.560	1
G 3"	-	-	56.0	63.0	80	38	18	1	1000.3G.630	1
G 3"	-	-	63.0	70.0	95	40	18	1	1000.3G.700	1

1 = Einteiliger Dichteinsatz

1 = One-piece sealing insert



1  
2  
3  
4  
5  
6  
7  
8  
9  
10  
11  
12  
13  
14  
15

# Kabelverschraubungen Progress® Messing für hohe Temperaturen

## Cable glands Progress® nickel-plated brass for high temperature applications

### Kurzes Anschlussgewinde metrisch | Short entry thread metric

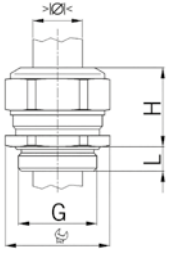

Material: Messing vernickelt  
 Dichtung: FPM  
 O-Ring: FPM  
 Zugentlastung: Ausführung A nach EN 62444  
 Schutzart: IP 68 (bis 10 bar) / IP 69  
 Einsatztemperatur: -40 °C / +200 °C

Material: Nickel-plated brass  
 Seal: FPM  
 O-ring: FPM  
 Strain relief: Version A acc. to EN 62444  
 Protection class: IP 68 (up to 10 bar) / IP 69  
 Operation temperature: -40 °C / +200 °C



Progress MS HT



Einteiliger Dichteinsatz  
 Nicht durchgehend isolierend

One-piece sealing insert  
 not overall length insulated

G	> < < min mm	> < < max mm	> < < mm	H mm	L mm	i info	Art.-No.	
M6x1.0	2.0	2.5	8	12	5	1	1000.06.91.025	50
M6x1.0	2.5	3.0	8	12	5	1	1000.06.91.030	50
M6x1.0	3.0	3.5	8	12	5	1	1000.06.91.035	50
M8x1.25	2.5	3.5	11	14	5	1	1000.08.91.035	50
M8x1.25	3.5	5.0	11	14	5	1	1000.08.91.050	50
M10x1.5	3.0	4.0	13	15	5	1	1000.10.91.040	50
M10x1.5	4.0	6.0	13	15	5	1	1000.10.91.060	50
M12x1.5	3.5	5.0	15	17	5	-	1000.12.91.050	50
M12x1.5	5.0	6.5	15	17	5	-	1000.12.91.065	50
M12x1.5	6.5	8.0	15	17	5	-	1000.12.91.080	50
M16x1.5	8.0	10.5	18	22	5	-	1000.17.91.105	50
M20x1.5	11.0	15.0	24	23	6	-	1000.20.91.150	50
M25x1.5	16.0	20.5	30	28	7	-	1000.25.91.205	25
M32x1.5	21.0	25.5	36	28	8	-	1000.32.91.255	25
M40x1.5	28.5	33.0	46	31	8	-	1000.40.91.330	10
M50x1.5	37.0	42.0	55	34	9	-	1000.50.91.420	10
M63x1.5	46.0	52.0	70	37	10	-	1000.63.91.520	5

1 = Metrisches Regelgewinde (mit VDE Testreport)

1 = Metric coarse-pitch thread (with VDE Testreport)

Zweiteiliger Dichteinsatz  
 Nicht durchgehend isolierend

Two-piece sealing insert  
 not overall length insulated

G	> < < min mm	> < < max mm	> < < min mm	> < < max mm	H mm	L mm	Art.-No.		
M16x1.5	6.0	8.0	8.0	10.5	18	22	5	1000.17.92	50
M20x1.5	8.0	11.0	11.0	15.0	24	23	6	1000.20.92	50
M25x1.5	12.5	16.0	16.0	20.5	30	28	7	1000.25.92	25
M32x1.5	17.0	21.0	21.0	25.5	36	28	8	1000.32.92	25
M40x1.5	24.0	28.5	28.5	33.0	46	31	8	1000.40.92	10
M50x1.5	33.0	37.0	37.0	42.0	55	34	9	1000.50.92	10
M63x1.5	40.0	46.0	46.0	52.0	70	37	10	1000.63.92	5

# Kabelverschraubungen Progress® Messing für hohe Temperaturen Cable glands Progress® nickel-plated brass for high temperature applications

## Langes Anschlussgewinde metrisch | Long entry thread metric

Material: Messing vernickelt  
Dichtung: FPM  
O-Ring: FPM  
Zugentlastung: Ausführung A nach EN 62444  
Schutzart: IP 68 (bis 10 bar) / IP 69  
Einsatztemperatur: -40 °C / +200 °C

Material: Nickel-plated brass  
Seal: FPM  
O-ring: FPM  
Strain relief: Version A acc. to EN 62444  
Protection class: IP 68 (up to 10 bar) / IP 69  
Operation temperature: -40 °C / +200 °C

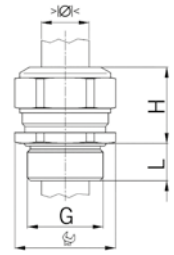

Einteiliger Dichteinsatz  
Nicht durchgehend isolierend

One-piece sealing insert  
not overall length insulated

G	$\varnothing_{\text{min}}$	$\varnothing_{\text{max}}$	$\varnothing_{\text{mm}}$	H	L	i	Art.-No.	
	min mm	max mm	mm	mm	mm	info		
M6x1.0	2.0	2.5	8	12	8	1	1100.06.91.025	50
M6x1.0	2.5	3.0	8	12	8	1	1100.06.91.030	50
M6x1.0	3.0	3.5	8	12	8	1	1100.06.91.035	50
M8x1.25	2.5	3.5	11	14	10	1	1100.08.91.035	50
M8x1.25	3.5	5.0	11	14	10	1	1100.08.91.050	50
M10x1.5	3.0	4.0	13	15	10	1	1100.10.91.040	50
M10x1.5	4.0	6.0	13	15	10	1	1100.10.91.060	50
M12x1.5	3.5	5.0	15	17	10	-	1100.12.91.050	50
M12x1.5	5.0	6.5	15	17	10	-	1100.12.91.065	50
M12x1.5	6.5	8.0	15	17	10	-	1100.12.91.080	50
M16x1.5	8.0	10.5	18	22	10	-	1100.17.91.105	50
M20x1.5	11.0	15.0	24	23	10	-	1100.20.91.150	50
M25x1.5	16.0	20.5	30	28	11	-	1100.25.91.205	25
M32x1.5	21.0	25.5	36	28	13	-	1100.32.91.255	25
M40x1.5	28.5	33.0	46	31	13	-	1100.40.91.330	10
M50x1.5	37.0	42.0	55	34	14	-	1100.50.91.420	10
M63x1.5	46.0	52.0	70	37	14	-	1100.63.91.520	5

1 = Metrisches Regelgewinde (mit VDE Testreport)

1 = Metric coarse-pitch thread (with VDE Testreport)

Zweiteiliger Dichteinsatz  
Nicht durchgehend isolierend

Two-piece sealing insert  
not overall length insulated

G	$\varnothing_{\text{min}}$	$\varnothing_{\text{max}}$	$\varnothing_{\text{min}}$	$\varnothing_{\text{max}}$	$\varnothing_{\text{mm}}$	H	L	Art.-No.	
	min mm	max mm	min mm	max mm	mm	mm	mm		
M16x1.5	6.0	8.0	8.0	10.5	18	22	10	1100.17.92	50
M20x1.5	8.0	11.0	11.0	15.0	24	23	10	1100.20.92	50
M25x1.5	12.5	16.0	16.0	20.5	30	28	11	1100.25.92	25
M32x1.5	17.0	21.0	21.0	25.5	36	28	13	1100.32.92	25
M40x1.5	24.0	28.5	28.5	33.0	46	31	13	1100.40.92	10
M50x1.5	33.0	37.0	37.0	42.0	55	34	14	1100.50.92	10
M63x1.5	40.0	46.0	46.0	52.0	70	37	14	1100.63.92	5



Progress MS HT



# Kabelverschraubungen Progress® Messing für hohe Temperaturen

## Cable glands Progress® nickel-plated brass for high temperature applications

### Kurzes Anschlussgewinde Pg | Short entry thread Pg

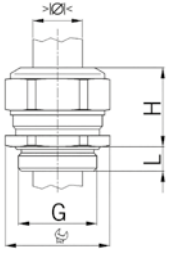

Material: Messing vernickelt  
 Dichtung: FPM  
 O-Ring: FPM  
 Schutzart: IP 68 (bis 10 bar) / IP 69  
 Einsatztemperatur: -40 °C / +200 °C

Material: Nickel-plated brass  
 Seal: FPM  
 O-ring: FPM  
 Protection class: IP 68 (up to 10 bar) / IP 69  
 Operation temperature: -40 °C / +200 °C



Einteiliger Dichteinsatz  
 Nicht durchgehend isolierend

One-piece sealing insert  
 not overall length insulated

G	$\varnothing_{\text{min}}$ mm	$\varnothing_{\text{max}}$ mm	$\varnothing_{\text{O-Ring}}$ mm	H mm	L mm	Art.-No.	
Pg 7	3.5	5.0	15	17	6	1000.07.91.050	50
Pg 7	5.0	6.5	15	17	6	1000.07.91.065	50
Pg 7	6.5	8.0	15	17	6	1000.07.91.080	50
Pg 9	8.0	10.5	18	22	6	1000.09.91.105	50
Pg 11	8.5	12.0	21	21	6	1000.11.91.120	50
Pg 13	11.0	15.0	24	23	6	1000.13.91.150	50
Pg 16	11.0	15.0	24	23	6	1000.16.91.150	50
Pg 21	16.0	20.5	30	28	7	1000.21.91.205	25
Pg 29	23.0	27.5	38	28	8	1000.29.91.275	25
Pg 36	30.5	35.0	50	32	8	1000.36.91.350	10
Pg 42	37.0	42.0	55	34	10	1000.42.91.420	10
Pg 48	43.0	49.0	65	37	11	1000.48.91.490	10

Zweiteiliger Dichteinsatz  
 Nicht durchgehend isolierend

Two-piece sealing insert  
 not overall length insulated

G	$\varnothing_{\text{min}}$ mm	$\varnothing_{\text{max}}$ mm	$\varnothing_{\text{min}}$ mm	$\varnothing_{\text{max}}$ mm	$\varnothing_{\text{O-Ring}}$ mm	H mm	L mm	Art.-No.	
Pg 9	6.0	8.0	8.0	10.5	18	22	6	1000.09.92	50
Pg 11	5.5	8.5	8.5	12.0	21	21	6	1000.11.92	50
Pg 13	8.0	11.0	11.0	15.0	24	23	6	1000.13.92	50
Pg 16	8.0	11.0	11.0	15.0	24	23	6	1000.16.92	50
Pg 21	12.5	16.0	16.0	20.5	30	28	7	1000.21.92	25
Pg 29	19.0	23.0	23.0	27.5	38	28	8	1000.29.92	25
Pg 36	26.0	30.5	30.5	35.0	50	32	8	1000.36.92	10
Pg 42	33.0	37.0	37.0	42.0	55	34	10	1000.42.92	10
Pg 48	37.0	43.0	43.0	49.0	65	37	11	1000.48.92	10

# Kabelverschraubungen Progress® Messing für hohe Temperaturen Cable glands Progress® nickel-plated brass for high temperature applications

## Langes Anschlussgewinde Pg | Long entry thread Pg

Material: Messing vernickelt  
Dichtung: FPM  
O-Ring: FPM  
Schutzart: IP 68 (bis 10 bar) / IP 69  
Einsatztemperatur: -40 °C / +200 °C

Material: Nickel-plated brass  
Seal: FPM  
O-ring: FPM  
Protection class: IP 68 (up to 10 bar) / IP 69  
Operation temperature: -40 °C / +200 °C

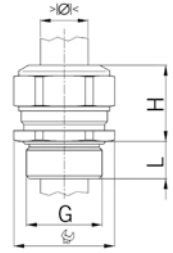

Einteiliger Dichteinsatz  
Nicht durchgehend isolierend

One-piece sealing insert  
not overall length insulated

G	$\begin{matrix} > \text{Ø} < \\ \text{min mm} \end{matrix}$	$\begin{matrix} > \text{Ø} < \\ \text{max mm} \end{matrix}$	$\begin{matrix} > \text{Ø} < \\ \text{mm} \end{matrix}$	$\begin{matrix} > \text{Ø} < \\ \text{mm} \end{matrix}$	$\begin{matrix} \text{Ø} \\ \text{mm} \end{matrix}$	H	L	Art.-No.	
Pg 7	3.5	5.0	15	17	10			1100.07.91.050	50
Pg 7	5.0	6.5	15	17	10			1100.07.91.065	50
Pg 7	6.5	8.0	15	17	10			1100.07.91.080	50
Pg 9	8.0	10.5	18	22	10			1100.09.91.105	50
Pg 11	8.5	12.0	21	21	10			1100.11.91.120	50
Pg 13	11.0	15.0	24	23	10			1100.13.91.150	50
Pg 16	11.0	15.0	24	23	10			1100.16.91.150	50
Pg 21	16.0	20.5	30	28	12			1100.21.91.205	25
Pg 29	23.0	27.5	38	28	12			1100.29.91.275	25
Pg 36	30.5	35.0	50	32	15			1100.36.91.350	10
Pg 42	37.0	42.0	55	34	15			1100.42.91.420	10
Pg 48	43.0	49.0	65	37	15			1100.48.91.490	10

Zweiteiliger Dichteinsatz  
Nicht durchgehend isolierend

Two-piece sealing insert  
not overall length insulated

G	$\begin{matrix} > \text{Ø} < \\ \text{min mm} \end{matrix}$	$\begin{matrix} > \text{Ø} < \\ \text{max mm} \end{matrix}$	$\begin{matrix} > \text{Ø} < \\ \text{min mm} \end{matrix}$	$\begin{matrix} > \text{Ø} < \\ \text{max mm} \end{matrix}$	$\begin{matrix} \text{Ø} \\ \text{mm} \end{matrix}$	H	L	Art.-No.	
Pg 9	6.0	8.0	8.0	10.5	18	22	10	1100.09.92	50
Pg 11	5.5	8.5	8.5	12.0	21	21	10	1100.11.92	50
Pg 13	8.0	11.0	11.0	15.0	24	23	10	1100.13.92	50
Pg 16	8.0	11.0	11.0	15.0	24	23	10	1100.16.92	50
Pg 21	12.5	16.0	16.0	20.5	30	28	12	1100.21.92	25
Pg 29	19.0	23.0	23.0	27.5	38	28	12	1100.29.92	25
Pg 36	26.0	30.5	30.5	35.0	50	32	15	1100.36.92	10
Pg 42	33.0	37.0	37.0	42.0	55	34	15	1100.42.92	10
Pg 48	37.0	43.0	43.0	49.0	65	37	15	1100.48.92	10

# Kabelverschraubungen Progress® Messing für mehrere Kabel

## Cable glands Progress® nickel-plated brass for installation of multiple cables

### Kurzes Anschlussgewinde metrisch | Short entry thread metric

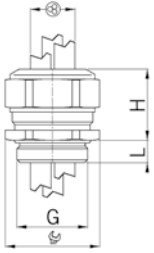

Material: Messing vernickelt  
 Dichtung: TPE  
 O-Ring: NBR  
 Zugentlastung: Ausführung A nach EN 62444  
 Schutzart: IP 68  
 Einsatztemperatur: -40 °C / +100 °C

Material: Nickel-plated brass  
 Seal: TPE  
 O-ring: NBR  
 Strain relief: Version A acc. to EN 62444  
 Protection class: IP 68  
 Operation temperature: -40 °C / +100 °C



Progress MS Multi



Einteiliger Dichteinsatz  
 Nicht durchgehend isolierend

One-piece sealing insert  
 not overall length insulated

G	> Ø <	> Ø <	⊗	⊗	H	L	Art.-No.	
	min mm	max mm	mm	mm	mm	mm		
M16x1.5	2.0	3.0	2	18	22	5	1310.17.2.030	50
M16x1.5	2.5	4.0	2	18	22	5	1310.17.2.040	50
M16x1.5	3.5	5.0	2	18	22	5	1310.17.2.050	50
M20x1.5	3.5	5.0	2	24	23	6	1310.20.2.050	50
M20x1.5	4.5	6.0	2	24	23	6	1310.20.2.060	50
M20x1.5	5.5	7.5	2	24	23	6	1310.20.2.075	50
M20x1.5	3.5	5.0	3	24	23	6	1310.20.3.050	50
M20x1.5	4.5	6.0	3	24	23	6	1310.20.3.060	50
M20x1.5	5.2	6.5	3	24	23	6	1310.20.3.065	50
M20x1.5	3.5	5.0	4	24	23	6	1310.20.4.050	50
M20x1.5	4.5	6.0	4	24	23	6	1310.20.4.060	50
M25x1.5	5.0	7.0	2	30	28	7	1310.25.2.070	25
M25x1.5	6.7	9.0	2	30	28	7	1310.25.2.090	25
M25x1.5	7.7	10.0	2	30	28	7	1310.25.2.100	25
M25x1.5	5.5	7.0	3	30	28	7	1310.25.3.070	25
M25x1.5	6.8	9.0	3	30	28	7	1310.25.3.090	25
M25x1.5	5.5	7.0	4	30	28	7	1310.25.4.070	25
M25x1.5	4.8	6.0	6	30	28	7	1310.25.6.060	25
M32x1.5	9.0	11.5	2	36	28	8	1310.32.2.115	25
M32x1.5	7.0	9.0	3	36	28	8	1310.32.3.090	25
M32x1.5	8.5	10.5	3	36	28	8	1310.32.3.105	25
M32x1.5	7.0	9.0	4	36	28	8	1310.32.4.090	25
M32x1.5	5.8	7.0	6	36	28	8	1310.32.6.070	25

Weitere Ausführungen und Anschlussgewinde auf Anfrage.

Further versions and entry threads are available upon request.

Erhältlich mit Dichteinsatz gemäss EN 45545 / NFPA 130. Bei Anfragen oder Bestellung bitte ein F vor die Artikelnummer setzen.

Available with sealing inserts conformity with EN 45545 / NFPA 130. When placing an inquiry, prefix the article number by the capital F.

# Kabelverschraubungen Progress® Messing für mehrere Kabel Cable glands Progress® nickel-plated brass for installation of multiple cables

## Kurzes Anschlussgewinde metrisch | Short entry thread metric

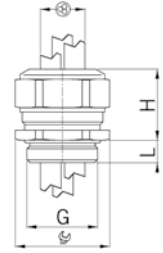

Material: Messing vernickelt  
Dichtung: TPE  
O-Ring: NBR  
Zugentlastung: Ausführung A nach EN 62444  
Schutzart: IP 68  
Einsatztemperatur: -40 °C / +100 °C

Material: Nickel-plated brass  
Seal: TPE  
O-ring: NBR  
Strain relief: Version A acc. to EN 62444  
Protection class: IP 68  
Operation temperature: -40 °C / +100 °C



Einteiliger Dichteinsatz  
Nicht durchgehend isolierend

One-piece sealing insert  
not overall length insulated

G	$\varnothing_{\text{min}}$ min mm	$\varnothing_{\text{max}}$ max mm	 mm	 mm	H mm	L mm	i info	Art.-No.	
M40x1.5	12.5	14.0	2	46	31	8	1	1310.40.2.140	10
M40x1.5	10.5	12.0	4	46	31	8	1	1310.40.4.120	10
M40x1.5	6.5	8.0	6	46	31	8	1	1310.40.6.080	10
M50x1.5	6.5	8.0	7	55	34	9	1	1310.50.7.080	10
M50x1.5	8.5	10.0	4	55	34	9	1	1310.50.4.100	10
M63x1.5	13.5	15.0	4	70	37	10	1	1310.63.4.150	5
M63x1.5	8.5	10.0	8	70	37	10	1	1310.63.8.100	5
M75x1.5	16.5	18.0	6	80	38	11	-	1310.75.6.180	1

Weitere Ausführungen und Anschlussgewinde auf Anfrage.

1= NBR Dichtung

Erhältlich mit Dichteinsatz gemäss EN 45545 / NFPA 130. Bei Anfragen oder Bestellung bitte ein F vor die Artikelnummer setzen.

Further versions and entry threads are available upon request.

1= NBR Seal

Available with sealing inserts conformity with EN 45545 / NFPA 130. When placing an inquiry, prefix the article number by the capital F.



1  
2  
3  
4  
5  
6  
7  
8  
9  
10  
11  
12  
13  
14  
15

# Kabelverschraubungen Progress® Messing für mehrere Kabel

## Cable glands Progress® nickel-plated brass for installation of multiple cables

### Langes Anschlussgewinde metrisch | Long entry thread metric

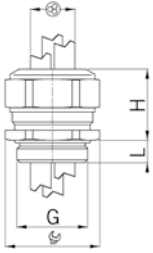

Material: Messing vernickelt  
 Dichtung: TPE  
 O-Ring: NBR  
 Zugentlastung: Ausführung A nach EN 62444  
 Schutzart: IP 68  
 Einsatztemperatur: -40 °C / +100 °C

Material: Nickel-plated brass  
 Seal: TPE  
 O-ring: NBR  
 Strain relief: Version A acc. to EN 62444  
 Protection class: IP 68  
 Operation temperature: -40 °C / +100 °C



Progress MS Multi



Einteiliger Dichteinsatz  
 Nicht durchgehend isolierend

One-piece sealing insert  
 not overall length insulated

G	> Ø <	> Ø <	⊗	⊗	H	L	Art.-No.	☐
	min mm	max mm	mm	mm	mm	mm		
M16x1.5	2.0	3.0	2	18	22	10	1311.17.2.030	50
M16x1.5	2.5	4.0	2	18	22	10	1311.17.2.040	50
M16x1.5	3.5	5.0	2	18	22	10	1311.17.2.050	50
M20x1.5	3.5	5.0	2	24	23	10	1311.20.2.050	50
M20x1.5	4.5	6.0	2	24	23	10	1311.20.2.060	50
M20x1.5	5.5	7.5	2	24	23	10	1311.20.2.075	50
M20x1.5	3.5	5.0	3	24	23	10	1311.20.3.050	50
M20x1.5	4.5	6.0	3	24	23	10	1311.20.3.060	50
M20x1.5	5.2	6.5	3	24	23	10	1311.20.3.065	50
M20x1.5	3.5	5.0	4	24	23	10	1311.20.4.050	50
M20x1.5	4.5	6.0	4	24	23	10	1311.20.4.060	50
M25x1.5	5.0	7.0	2	30	28	11	1311.25.2.070	25
M25x1.5	6.7	9.0	2	30	28	11	1311.25.2.090	25
M25x1.5	7.7	10.0	2	30	28	11	1311.25.2.100	25
M25x1.5	5.5	7.0	3	30	28	11	1311.25.3.070	25
M25x1.5	6.8	9.0	3	30	28	11	1311.25.3.090	25
M25x1.5	5.5	7.0	4	30	28	11	1311.25.4.070	25
M25x1.5	4.8	6.0	6	30	28	11	1311.25.6.060	25
M32x1.5	9.0	11.5	2	36	28	13	1311.32.2.115	25
M32x1.5	7.0	9.0	3	36	28	13	1311.32.3.090	25
M32x1.5	8.5	10.5	3	36	28	13	1311.32.3.105	25
M32x1.5	7.0	9.0	4	36	28	13	1311.32.4.090	25
M32x1.5	5.8	7.0	6	36	28	13	1311.32.6.070	25

Weitere Ausführungen und Anschlussgewinde auf Anfrage.

Further versions and entry threads are available upon request.

Erhältlich mit Dichteinsatz gemäss EN 45545 / NFPA 130. Bei Anfragen oder Bestellung bitte ein F vor die Artikelnummer setzen.

Available with sealing inserts conformity with EN 45545 / NFPA 130. When placing an inquiry, prefix the article number by the capital F.

# Kabelverschraubungen Progress® Messing für mehrere Kabel Cable glands Progress® nickel-plated brass for installation of multiple cables

## Langes Anschlussgewinde metrisch | Long entry thread metric

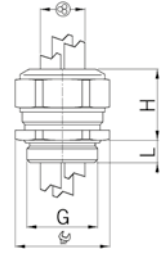

Material: Messing vernickelt  
Dichtung: TPE  
O-Ring: NBR  
Zugentlastung: Ausführung A nach EN 62444  
Schutzart: IP 68  
Einsatztemperatur: -40 °C / +100 °C

Material: Nickel-plated brass  
Seal: TPE  
O-ring: NBR  
Strain relief: Version A acc. to EN 62444  
Protection class: IP 68  
Operation temperature: -40 °C / +100 °C



Einteiliger Dichteinsatz  
Nicht durchgehend isolierend

One-piece sealing insert  
not overall length insulated

G	$\varnothing_{\text{min}}$ min mm	$\varnothing_{\text{max}}$ max mm	 mm	 mm	H mm	L mm	i info
<b>M40x1.5</b>	12.5	14.0	2	46	31	13	1
<b>M40x1.5</b>	10.5	12.0	4	46	31	13	1
<b>M40x1.5</b>	6.5	8.0	6	46	31	13	1
<b>M50x1.5</b>	8.5	10.0	4	55	34	14	1
<b>M50x1.5</b>	6.5	8.0	7	55	34	14	1
<b>M63x1.5</b>	13.5	15.0	4	70	37	14	1
<b>M63x1.5</b>	8.5	10.0	8	70	37	14	1
<b>M75x1.5</b>	16.5	18.0	6	80	38	15	-

Art.-No.



<b>1311.40.2.140</b>	10
<b>1311.40.4.120</b>	10
<b>1311.40.6.080</b>	10
<b>1311.50.4.100</b>	10
<b>1311.50.7.080</b>	10
<b>1311.63.4.150</b>	5
<b>1311.63.8.100</b>	5
<b>1311.75.6.180</b>	1

Weitere Ausführungen und Anschlussgewinde auf Anfrage.

Further versions and entry threads are available upon request.

1= NBR Dichtung

1= NBR Seal

Erhältlich mit Dichteinsatz gemäss EN 45545 / NFPA 130. Bei Anfragen oder Bestellung bitte ein F vor die Artikelnummer setzen.

Available with sealing inserts conformity with EN 45545 / NFPA 130. When placing an inquiry, prefix the article number by the capital F.



# Kabelverschraubungen Progress® Messing für mehrere Kabel

## Cable glands Progress® nickel-plated brass for installation of multiple cables

### Kurzes Anschlussgewinde Pg | Short entry thread Pg

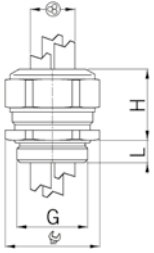

Material: Messing vernickelt  
 Dichtung: TPE  
 O-Ring: NBR  
 Schutzart: IP 68  
 Einsatztemperatur: -40 °C / +100 °C

Material: Nickel-plated brass  
 Seal: TPE  
 O-ring: NBR  
 Protection class: IP 68  
 Operation temperature: -40 °C / +100 °C



Einteiliger Dichteinsatz  
 Nicht durchgehend isolierend

One-piece sealing insert  
 not overall length insulated

G	$\gt;\varnothing\lt;$ min mm	$\gt;\varnothing\lt;$ max mm			H mm	L mm	Art.-No.	
Pg 9	2.0	3.0	2	18	22	6.0	1310.09.2.030	50
Pg 9	2.5	4.0	2	18	22	6.0	1310.09.2.040	50
Pg 9	3.5	5.0	2	18	22	6.0	1310.09.2.050	50
Pg 11	3.5	5.0	2	21	21	6.0	1310.11.2.050	50
Pg 11	4.5	6.0	2	21	21	6.0	1310.11.2.060	50
Pg 11	5.5	7.5	2	24	23	6.0	1310.11.2.075	50
Pg 11	3.5	5.0	3	21	21	6.0	1310.11.3.050	50
Pg 13	3.5	5.0	2	24	23	6.0	1310.13.2.050	50
Pg 13	4.5	6.0	2	24	23	6.0	1310.13.2.060	50
Pg 13	5.5	7.5	2	24	23	6.0	1310.13.2.075	50
Pg 13	3.5	5.0	3	24	23	6.0	1310.13.3.050	50
Pg 13	4.5	6.0	3	24	23	6.0	1310.13.3.060	50
Pg 13	5.2	6.5	3	24	23	6.0	1310.13.3.065	50
Pg 13	3.5	5.0	4	24	23	6.0	1310.13.4.050	50
Pg 13	4.5	6.0	4	24	23	6.0	1310.13.4.060	50
Pg 16	3.5	5.0	2	24	23	6.0	1310.16.2.050	50
Pg 16	4.5	6.0	2	24	23	6.0	1310.16.2.060	50
Pg 16	5.5	7.5	2	24	23	6.0	1310.16.2.075	50
Pg 16	6.7	9.0	2	30	28	6.0	1310.16.2.090	25
Pg 16	3.5	5.0	3	24	23	6.0	1310.16.3.050	50
Pg 16	4.5	6.0	3	24	23	6.0	1310.16.3.060	50
Pg 16	5.0	7.0	3	30	28	6.0	1310.16.3.070	25
Pg 16	3.5	5.0	4	24	23	6.0	1310.16.4.050	50
Pg 16	4.5	6.0	4	24	23	6.0	1310.16.4.060	50
Pg 16	5.5	7.0	4	30	28	6.0	1310.16.4.070	25
Pg 21	5.0	7.0	2	30	28	7.5	1310.21.2.070	25
Pg 21	6.7	9.0	2	30	28	7.5	1310.21.2.090	25
Pg 21	7.7	10.0	2	30	28	7.5	1310.21.2.100	25
Pg 21	9.0	11.5	2	36	28	7.5	1310.21.2.115	25
Pg 21	5.5	7.0	3	30	28	7.5	1310.21.3.070	25
Pg 21	6.8	9.0	3	30	28	7.5	1310.21.3.090	25
Pg 21	8.5	10.5	3	36	28	7.5	1310.21.3.105	25
Pg 21	5.5	7.0	4	30	28	7.5	1310.21.4.070	25
Pg 21	7.0	9.0	4	36	28	7.5	1310.21.4.090	25
Pg 21	4.8	6.0	6	30	28	7.5	1310.21.6.060	25
Pg 21	5.8	7.0	6	36	28	7.5	1310.21.6.070	25
Pg 29	7.5	9.0	3	38	28	8.0	1310.29.3.090	25

Weitere Ausführungen und Anschlussgewinde auf Anfrage.

Further versions and entry threads are available upon request.

Erhältlich mit Dichteinsatz gemäss EN 45545 / NFPA 130. Bei Anfragen oder Bestellung bitte ein F vor die Artikelnummer setzen.

Available with sealing inserts conformity with EN 45545 / NFPA 130. When placing an inquiry, prefix the article number by the capital F.

# Kabelverschraubungen Progress® Messing für mehrere Kabel Cable glands Progress® nickel-plated brass for installation of multiple cables

## Langes Anschlussgewinde Pg | Long entry thread Pg

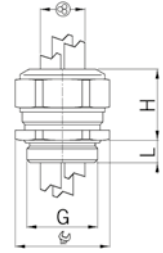

Material: Messing vernickelt  
Dichtung: TPE  
O-Ring: NBR  
Schutzart: IP 68  
Einsatztemperatur: -40 °C / +100 °C

Material: Nickel-plated brass  
Seal: TPE  
O-ring: NBR  
Protection class: IP 68  
Operation temperature: -40 °C / +100 °C



Einteiliger Dichteinsatz  
Nicht durchgehend isolierend

One-piece sealing insert  
not overall length insulated

G	$\begin{matrix} > \ominus < \\ \text{min mm} \end{matrix}$	$\begin{matrix} > \ominus < \\ \text{max mm} \end{matrix}$			H mm	L mm	Art.-No.	
Pg 9	2.0	3.0	2	18	22	10	1311.09.2.030	50
Pg 9	2.5	4.0	2	18	22	10	1311.09.2.040	50
Pg 9	3.5	5.0	2	18	22	10	1311.09.2.050	50
Pg 11	3.5	5.0	2	21	21	10	1311.11.2.050	50
Pg 11	4.5	6.0	2	21	21	10	1311.11.2.060	50
Pg 11	5.5	7.5	2	24	23	10	1311.11.2.075	50
Pg 11	3.5	5.0	3	21	21	10	1311.11.3.050	50
Pg 13	3.5	5.0	2	24	23	10	1311.13.2.050	50
Pg 13	4.5	6.0	2	24	23	10	1311.13.2.060	50
Pg 13	5.5	7.5	2	24	23	10	1311.13.2.075	50
Pg 13	3.5	5.0	3	24	23	10	1311.13.3.050	50
Pg 13	4.5	6.0	3	24	23	10	1311.13.3.060	50
Pg 13	5.2	6.5	3	24	23	10	1311.13.3.065	50
Pg 13	3.5	5.0	4	24	23	10	1311.13.4.050	50
Pg 13	4.5	6.0	4	24	23	10	1311.13.4.060	50
Pg 16	3.5	5.0	2	24	23	10	1311.16.2.050	50
Pg 16	4.5	6.0	2	24	23	10	1311.16.2.060	50
Pg 16	5.5	7.5	2	24	23	10	1311.16.2.075	50
Pg 16	6.7	9.0	2	30	28	10	1311.16.2.090	25
Pg 16	3.5	5.0	3	24	23	10	1311.16.3.050	50
Pg 16	4.5	6.0	3	24	23	10	1311.16.3.060	50
Pg 16	5.0	7.0	3	30	28	10	1311.16.3.070	25
Pg 16	3.5	5.0	4	24	23	10	1311.16.4.050	50
Pg 16	4.5	6.0	4	24	23	10	1311.16.4.060	50
Pg 16	5.5	7.0	4	30	28	10	1311.16.4.070	25
Pg 21	5.0	7.0	2	30	28	12	1311.21.2.070	25
Pg 21	6.7	9.0	2	30	28	12	1311.21.2.090	25
Pg 21	7.7	10.0	2	30	28	12	1311.21.2.100	25
Pg 21	9.0	11.5	2	36	28	12	1311.21.2.115	25
Pg 21	5.5	7.0	3	30	28	12	1311.21.3.070	25
Pg 21	6.8	9.0	3	30	28	12	1311.21.3.090	25
Pg 21	8.5	10.5	3	36	28	12	1311.21.3.105	25
Pg 21	5.5	7.0	4	30	28	12	1311.21.4.070	25
Pg 21	7.0	9.0	4	36	28	12	1311.21.4.090	25
Pg 21	4.8	6.0	6	30	28	12	1311.21.6.060	25
Pg 21	5.8	7.0	6	36	28	12	1311.21.6.070	25
Pg 29	7.5	9.0	3	38	28	12	1311.29.3.090	25



Weitere Ausführungen und Anschlussgewinde auf Anfrage.

Further versions and entry threads are available upon request.

Erhältlich mit Dichteinsatz gemäss EN 45545 / NFPA 130. Bei Anfragen oder Bestellung bitte ein F vor die Artikelnummer setzen.

Available with sealing inserts conformity with EN 45545 / NFPA 130. When placing an inquiry, prefix the article number by the capital F.

# Kabelverschraubungen Progress® Messing mit Dichteinsatz ohne Bohrung

## Cable glands Progress® nickel-plated brass with sealing insert without drilled hole

### Kurzes Anschlussgewinde metrisch | Short entry thread metric

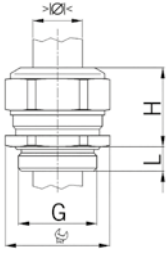

Material: Messing vernickelt  
 Dichtung: NBR, ohne Bohrung  
 O-Ring: NBR  
 Schutzart: IP 68 (bis 10 bar) / IP 69  
 Einsatztemperatur: -40 °C / +100 °C

Material: Nickel-plated brass  
 Seal: NBR, without drilled hole  
 O-ring: NBR  
 Protection class: IP 68 (up to 10 bar) / IP 69  
 Operation temperature: -40 °C / +100 °C



Einteiliger Dichteinsatz ohne Bohrung  
 Nicht durchgehend isolierend

One-piece solid sealing insert  
 not overall length insulated

G	>Ø< max mm	H mm	L mm	i info	Art.-No.	
M6x1.0	3.5	8	12	5 1	1000.06.30	50
M8x1.25	5.0	11	14	5 1	1000.08.30	50
M10x1.5	6.0	13	15	5 1	1000.10.30	50
M12x1.5	8.0	15	17	5 -	1000.12.30	50
M16x1.5	10.5	18	22	5 -	1000.17.30	50
M20x1.5	15.0	24	23	6 -	1000.20.30	50
M25x1.5	20.5	30	28	7 -	1000.25.30	25
M32x1.5	25.5	36	28	8 -	1000.32.30	25
M40x1.5	33.0	46	31	8 -	1000.40.30	10
M50x1.5	42.0	55	34	9 -	1000.50.30	10
M63x1.5	52.0	70	37	10 -	1000.63.30	5

1 = Metrisches Regelgewinde

1 = Metric coarse-pitch thread

Erhältlich mit Dichteinsatz gemäss EN 45545 / NFPA 130. Bei Anfragen oder Bestellung bitte ein F vor die Artikelnummer setzen.

Available with sealing inserts conformity with EN 45545 / NFPA 130. When placing an inquiry, prefix the article number by the capital F.

Dichteinsätze ohne Bohrung lassen sich gut bearbeiten, wenn sie vorher auf mindestens -25°C gefroren wurden.

When frozen to at least -25°C, the solid sealing inserts are easy to drill.

### Kurzes Anschlussgewinde Pg | Short entry thread Pg



Einteiliger Dichteinsatz ohne Bohrung  
 Nicht durchgehend isolierend

One-piece solid sealing insert  
 not overall length insulated

G	>Ø< max mm	H mm	L mm	Art.-No.		
Pg 7	8.0	15	17	6.0	1000.07.30	50
Pg 9	10.5	18	22	6.0	1000.09.30	50
Pg 11	12.0	21	21	6.0	1000.11.30	50
Pg 11	15.0	24	23	6.0	1000.11.20.30	50
Pg 13	15.0	24	23	6.0	1000.13.30	50
Pg 16	15.0	24	23	6.0	1000.16.30	50
Pg 16	18.5	30	28	6.0	1000.16.25.30	25
Pg 21	20.5	30	28	7.5	1000.21.30	25
Pg 21	23.0	36	28	7.5	1000.21.32.30	25
Pg 29	27.5	38	28	8.0	1000.29.30	25
Pg 29	33.0	46	31	8.0	1000.29.40.30	25
Pg 36	35.0	50	32	8.0	1000.36.30	10
Pg 36	42.0	55	34	8.0	1000.36.50.30	10
Pg 42	42.0	55	34	10.0	1000.42.30	10
Pg 48	49.0	65	37	11.0	1000.48.30	10

Erhältlich mit Dichteinsatz gemäss EN 45545 / NFPA 130. Bei Anfragen oder Bestellung bitte ein F vor die Artikelnummer setzen.

Available with sealing inserts conformity with EN 45545 / NFPA 130. When placing an inquiry, prefix the article number by the capital F.

Dichteinsätze ohne Bohrung lassen sich gut bearbeiten, wenn sie vorher auf mindestens -25°C gefroren wurden.

When frozen to at least -25°C, the solid sealing inserts are easy to drill.

# Kabelverschraubungen Progress® Messing mit Dichteinsatz ohne Bohrung

## Cable glands Progress® nickel-plated brass with sealing insert without drilled hole

### Kurzes Anschlussgewinde metrisch | Short entry thread metric

Material: Messing vernickelt  
 Dichtung: FPM, ohne Bohrung  
 O-Ring: FPM  
 Schutzart: IP 68 (bis 10 bar) / IP 69  
 Einsatztemperatur: -40 °C / +200 °C

Material: Nickel-plated brass  
 Seal: FPM, without drilled hole  
 O-ring: FPM  
 Protection class: IP 68 (up to 10 bar) / IP 69  
 Operation temperature: -40 °C / +200 °C

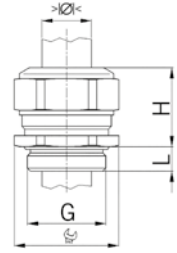

Für hohe Temperaturen  
 Einteiliger Dichteinsatz ohne Bohrung  
 Nicht durchgehend isolierend

For high temperature applications  
 One-piece solid sealing insert  
 not overall length insulated

G	$\gt;\varnothing<$ max mm	 mm	H mm	L mm	i info	Art.-No.	
M6x1.0	3.5	8	12	5	1	1000.06.30.91	50
M8x1.25	5.0	11	14	5	1	1000.08.30.91	50
M10x1.5	6.0	13	15	5	1	1000.10.30.91	50
M12x1.5	8.0	15	17	5	-	1000.12.30.91	50
M16x1.5	10.5	18	22	5	-	1000.17.30.91	50
M20x1.5	15.0	24	23	6	-	1000.20.30.91	50
M25x1.5	20.5	30	28	7	-	1000.25.30.91	25
M32x1.5	25.5	36	28	8	-	1000.32.30.91	25
M40x1.5	33.0	46	31	8	-	1000.40.30.91	10
M50x1.5	42.0	55	34	9	-	1000.50.30.91	10
M63x1.5	52.0	70	37	10	-	1000.63.30.91	5

1 = Metrisches Regelgewinde

1 = Metric coarse-pitch thread

Dichteinsätze ohne Bohrung lassen sich gut bearbeiten, wenn sie vorher auf mindestens -25°C gefroren wurden.

When frozen to at least -25°C, the solid sealing inserts are easy to drill.



### Kurzes Anschlussgewinde Pg | Short entry thread Pg

Für hohe Temperaturen  
 Einteiliger Dichteinsatz ohne Bohrung  
 Nicht durchgehend isolierend

For high temperature applications  
 One-piece solid sealing insert  
 not overall length insulated

G	$\gt;\varnothing<$ max mm	 mm	H mm	L mm	Art.-No.	
Pg 7	8.0	15	17	6.0	1000.07.30.91	50
Pg 9	10.5	18	22	6.0	1000.09.30.91	50
Pg 11	12.0	21	21	6.0	1000.11.30.91	50
Pg 11	15.0	24	23	6.0	1000.11.20.30.91	50
Pg 13	15.0	24	23	6.0	1000.13.30.91	50
Pg 16	15.0	24	23	6.0	1000.16.30.91	50
Pg 16	18.5	30	28	6.0	1000.16.25.30.91	25
Pg 21	20.5	30	28	7.5	1000.21.30.91	25
Pg 21	23.0	36	28	7.5	1000.21.32.30.91	25
Pg 29	27.5	38	28	8.0	1000.29.30.91	25
Pg 29	33.0	46	31	8.0	1000.29.40.30.91	25
Pg 36	35.0	50	32	8.0	1000.36.30.91	10
Pg 36	42.0	55	34	8.0	1000.36.50.30.91	10
Pg 42	42.0	55	34	10.0	1000.42.30.91	10
Pg 48	49.0	65	37	11.0	1000.48.30.91	10

Dichteinsätze ohne Bohrung lassen sich gut bearbeiten, wenn sie vorher auf mindestens -25°C gefroren wurden.

When frozen to at least -25°C, the solid sealing inserts are easy to drill.



# Kabelverschraubungen Progress® Messing für Flachkabel Cable glands Progress® nickel-plated brass for flat cables

## Kurzes Anschlussgewinde metrisch | Short entry thread metric

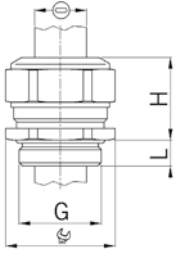

Material: Messing vernickelt  
Dichtung: TPE  
O-Ring: NBR  
Zugentlastung: Ausführung A nach EN 62444  
Schutzart: IP 68  
Einsatztemperatur: -40 °C / +100 °C

Material: Nickel-plated brass  
Seal: TPE  
O-ring: NBR  
Strain relief: Version A acc. to EN 62444  
Protection class: IP 68  
Operation temperature: -40 °C / +100 °C



Progress MS FK



Einteiliger Dichteinsatz  
Nicht durchgehend isolierend

One-piece sealing insert  
not overall length insulated

G	min mm	max mm	mm	H mm	L mm	Art.-No.	
M16x1.5	7.3x2.5	9.0x4.2	18	22	5	1300.17.090.042	50
M20x1.5	10.5x2.5	13.0x5.0	24	23	6	1300.20.130.050	50
M20x1.5	12.5x2.5	15.0x5.0	24	23	6	1300.20.150.050	50
M25x1.5	16.0x4.0	19.0x7.0	30	28	7	1300.25.190.070	25
M32x1.5	19.0x3.0	22.0x6.0	36	28	8	1300.32.220.060	25
M32x1.5	19.0x5.0	22.0x8.0	36	28	8	1300.32.220.080	25
M40x1.5	23.0x4.0	26.0x7.0	46	31	8	1300.40.260.070	10
M40x1.5	23.5x6.0	26.5x9.0	46	31	8	1300.40.265.090	10
M40x1.5	25.0x3.0	28.0x6.0	46	31	8	1300.40.280.060	10
M40x1.5	27.0x7.0	30.0x10.0	46	31	8	1300.40.300.100	10
M40x1.5	29.0x6.0	32.0x9.0	46	31	8	1300.40.320.090	10
M40x1.5	30.0x3.5	33.0x6.5	46	31	8	1300.40.330.065	10
M50x1.5	31.0x8.5	34.0x11.5	55	34	9	1300.50.340.115	10
M50x1.5	34.0x4.0	37.0x7.0	55	34	9	1300.50.370.070	10
M50x1.5	36.5x2.5	40.0x6.0	55	34	9	1300.50.400.060	10
M50x1.5	36.5x10.0	40.0x13.5	55	34	9	1300.50.400.135	10
M50x1.5	38.5x10.5	42.0x14.0	55	34	9	1300.50.420.140	10
M63x1.5	42.0x10.0	46.0x14.0	70	37	10	1300.63.460.140	5
M63x1.5	42.5x2.0	46.5x6.0	70	37	10	1300.63.465.060	5

Erhältlich mit Dichteinsatz gemäss EN 45545 / NFPA 130.  
Bei Anfragen oder Bestellung bitte ein F vor die Artikelnummer setzen.

Available with sealing inserts conformity with EN 45545 / NFPA 130. When placing an inquiry, prefix the article number by the capital F.

# Kabelverschraubungen Progress® Messing für Flachkabel Cable glands Progress® nickel-plated brass for flat cables

## Langes Anschlussgewinde metrisch | Long entry thread metric



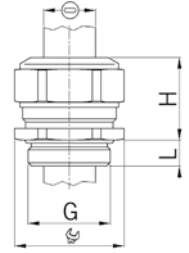

Material: Messing vernickelt  
Dichtung: TPE  
O-Ring: NBR  
Zugentlastung: Ausführung A nach EN 62444  
Schutzart: IP 68  
Einsatztemperatur: -40 °C / +100 °C

Material: Nickel-plated brass  
Seal: TPE  
O-ring: NBR  
Strain relief: Version A acc. to EN 62444  
Protection class: IP 68  
Operation temperature: -40 °C / +100 °C



Einteiliger Dichteinsatz  
Nicht durchgehend isolierend

One-piece sealing insert  
not overall length insulated

G	 min mm	 max mm	 min	H mm	L mm	Art.-No.	
M16x1.5	7.3x2.5	9.0x4.2	18	22	10	1301.17.090.042	50
M20x1.5	10.5x2.5	13.0x5.0	24	23	10	1301.20.130.050	50
M20x1.5	12.5x2.5	15.0x5.0	24	23	10	1301.20.150.050	50
M25x1.5	16.0x4.0	19.0x7.0	30	28	11	1301.25.190.070	25
M32x1.5	19.0x3.0	22.0x6.0	36	28	13	1301.32.220.060	25
M32x1.5	19.0x5.0	22.0x8.0	36	28	13	1301.32.220.080	25
M40x1.5	23.0x4.0	26.0x7.0	46	31	13	1301.40.260.070	10
M40x1.5	23.5x6.0	26.5x9.0	46	31	13	1301.40.265.090	10
M40x1.5	25.0x3.0	28.0x6.0	46	31	13	1301.40.280.060	10
M40x1.5	27.0x7.0	30.0x10.0	46	31	13	1301.40.300.100	10
M40x1.5	29.0x6.0	32.0x9.0	46	31	13	1301.40.320.090	10
M40x1.5	30.0x3.5	33.0x6.5	46	31	13	1301.40.330.065	10
M50x1.5	31.0x8.5	34.0x11.5	55	34	14	1301.50.340.115	10
M50x1.5	34.0x4.0	37.0x7.0	55	34	14	1301.50.370.070	10
M50x1.5	36.5x2.5	40.0x6.0	55	34	14	1301.50.400.060	10
M50x1.5	36.5x10.0	40.0x13.5	55	34	14	1301.50.400.135	10
M50x1.5	38.5x10.5	42.0x14.0	55	34	14	1301.50.420.140	10
M63x1.5	42.0x10.0	46.0x14.0	70	37	14	1301.63.460.140	5
M63x1.5	42.5x2.0	46.5x6.0	70	37	14	1301.63.465.060	5

Erhältlich mit Dichteinsatz gemäss EN 45545 / NFPA 130.  
Bei Anfragen oder Bestellung bitte ein F vor die Artikelnummer setzen.

Available with sealing inserts conformity with EN 45545 / NFPA 130. When placing an inquiry, prefix the article number by the capital F.



Progress MS FK



# Kabelverschraubungen Progress® Messing für Flachkabel

## Cable glands Progress® nickel-plated brass for flat cables

### Kurzes Anschlussgewinde Pg | Short entry thread Pg

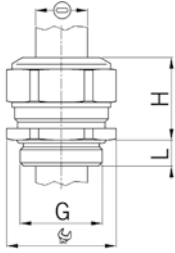

Material: Messing vernickelt  
 Dichtung: TPE  
 O-Ring: NBR  
 Schutzart: IP 68  
 Einsatztemperatur: -40 °C / +100 °C

Material: Nickel-plated brass  
 Seal: TPE  
 O-ring: NBR  
 Protection class: IP 68  
 Operation temperature: -40 °C / +100 °C



Einteiliger Dichteinsatz  
 Nicht durchgehend isolierend

One-piece sealing insert  
 not overall length insulated

G	min mm	max mm	mm	H mm	L mm	Art.-No.	
Pg 9	7.3x2.5	9.0x4.2	18	22	6.0	1300.09.090.042	50
Pg 13	10.5x2.5	13.0x5.0	24	23	6.0	1300.13.130.050	50
Pg 13	12.5x2.5	15.0x5.0	24	23	6.0	1300.13.150.050	50
Pg 16	10.5x2.5	13.0x5.0	24	23	6.0	1300.16.130.050	50
Pg 16	12.5x2.5	15.0x5.0	24	23	6.0	1300.16.150.050	50
Pg 21	16.0x4.0	19.0x7.0	30	28	7.5	1300.21.190.070	25
Pg 21	19.0x3.0	22.0x6.0	36	28	7.5	1300.21.220.060	25
Pg 21	19.0x5.0	22.0x8.0	36	28	7.5	1300.21.220.080	25
Pg 29	23.0x4.0	26.0x7.0	46	31	8.0	1300.29.260.070	25
Pg 29	23.5x6.0	26.5x9.0	46	31	8.0	1300.29.265.090	25
Pg 29	25.0x3.0	28.0x6.0	46	31	8.0	1300.29.280.060	25
Pg 29	27.0x7.0	30.0x10.0	46	31	8.0	1300.29.300.100	25
Pg 29	29.0x6.0	32.0x9.0	46	31	8.0	1300.29.320.090	25
Pg 29	30.0x3.5	33.0x6.5	46	31	8.0	1300.29.330.065	25
Pg 42	31.0x8.5	34.0x11.5	55	34	10.0	1300.42.340.115	10
Pg 42	34.0x4.0	37.0x7.0	55	34	10.0	1300.42.370.070	10
Pg 42	36.5x2.5	40.0x6.0	55	34	10.0	1300.42.400.060	10
Pg 42	36.5x10.0	40.0x13.5	55	34	10.0	1300.42.400.135	10
Pg 42	38.5x10.5	42.0x14.0	55	34	10.0	1300.42.420.140	10
Pg 48	42.0x10.0	46.0x14.0	65	37	11.0	1300.48.460.140	10
Pg 48	42.5x2.0	46.5x6.0	65	37	11.0	1300.48.465.060	10

### Langes Anschlussgewinde Pg | Long entry thread Pg



Einteiliger Dichteinsatz  
 Nicht durchgehend isolierend

One-piece sealing insert  
 not overall length insulated

G	min mm	max mm	mm	H mm	L mm	Art.-No.	
Pg 9	7.3x2.5	9.0x4.2	18	22	10	1301.09.090.042	50
Pg 13	10.5x2.5	13.0x5.0	24	23	10	1301.13.130.050	50
Pg 13	12.5x2.5	15.0x5.0	24	23	10	1301.13.150.050	50
Pg 16	10.5x2.5	13.0x5.0	24	23	10	1301.16.130.050	50
Pg 16	12.5x2.5	15.0x5.0	24	23	10	1301.16.150.050	50
Pg 21	16.0x4.0	19.0x7.0	30	28	12	1301.21.190.070	25
Pg 21	19.0x3.0	22.0x6.0	36	28	12	1301.21.220.060	25
Pg 21	19.0x5.0	22.0x8.0	36	28	12	1301.21.220.080	25
Pg 29	23.0x4.0	26.0x7.0	46	31	12	1301.29.260.070	25
Pg 29	23.5x6.0	26.5x9.0	46	31	12	1301.29.265.090	25
Pg 29	25.0x3.0	28.0x6.0	46	31	12	1301.29.280.060	25
Pg 29	27.0x7.0	30.0x10.0	46	31	12	1301.29.300.100	25
Pg 29	29.0x6.0	32.0x9.0	46	31	12	1301.29.320.090	25
Pg 29	30.0x3.5	33.0x6.5	46	31	12	1301.29.330.065	25
Pg 42	31.0x8.5	34.0x11.5	55	34	15	1301.42.340.115	10
Pg 42	34.0x4.0	37.0x7.0	55	34	15	1301.42.370.070	10
Pg 42	36.5x2.5	40.0x6.0	55	34	15	1301.42.400.060	10
Pg 42	36.5x10.0	40.0x13.5	55	34	15	1301.42.400.135	10
Pg 42	38.5x10.5	42.0x14.0	55	34	15	1301.42.420.140	10
Pg 48	42.0x10.0	46.0x14.0	65	37	15	1301.48.460.140	10
Pg 48	42.5x2.0	46.5x6.0	65	37	15	1301.48.465.060	10

# Kabelverschraubungen Progress® Messing mit speziellem Anschlussgewinde Cable glands Progress® nickel-plated brass with special entry thread

## Speziell langes Anschlussgewinde metrisch | Extra-long entry thread metric

Material:	Messing vernickelt	Material:	Nickel-plated brass
Dichtung:	TPE	Seal:	TPE
O-Ring:	NBR	O-ring:	NBR
Zugentlastung:	Ausführung A nach EN 62444	Strain relief:	Version A acc. to EN 62444
Schutzart:	IP 68 (bis 10 bar) / IP 69	Protection class:	IP 68 (up to 10 bar) / IP 69
Einsatztemperatur:	-40 °C / +100 °C	Operation temperature:	-40 °C / +100 °C

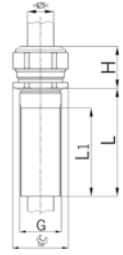

Zweiteiliger Dichteinsatz  
Nicht durchgehend isolierend

Two-piece sealing insert  
not overall length insulated

G	> Ø <	> Ø <	> Ø <	> Ø <	mm	H	L1	L	Art.-No.	mm
	min mm	max mm	min mm	max mm		mm	mm	mm		
M16x1.5	6.0	8.0	8.0	10.5	24/18	22	40	50	1100.17.50	10
M16x1.5	6.0	8.0	8.0	10.5	24/18	22	60	100	1100.17.51	10
M20x1.5	8.0	11.0	11.0	15.0	30/24	23	40	50	1100.20.50	10
M20x1.5	8.0	11.0	11.0	15.0	30/24	23	60	100	1100.20.51	10
M25x1.5	12.5	16.0	16.0	20.5	36/30	28	40	50	1100.25.50	10
M25x1.5	12.5	16.0	16.0	20.5	36/30	28	60	100	1100.25.51	10
M32x1.5	17.0	21.0	21.0	25.5	46/36	28	40	50	1100.32.50	10
M32x1.5	17.0	21.0	21.0	25.5	46/36	28	60	100	1100.32.51	10
M40x1.5	24.0	28.5	28.5	33.0	55/46	31	40	50	1100.40.50	10

Weitere Abmessungen auf Anfrage

Further dimensions upon request



Progress MS L



## Speziell langes Anschlussgewinde Pg | Specially long entry thread Pg

Material:	Messing vernickelt	Material:	Nickel-plated brass
Dichtung:	TPE	Seal:	TPE
O-Ring:	NBR	O-ring:	NBR
Schutzart:	IP 68 (bis 10 bar) / IP 69	Protection class:	IP 68 (up to 10 bar) / IP 69
Einsatztemperatur:	-40 °C / +100 °C	Operation temperature:	-40 °C / +100 °C

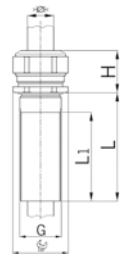

Zweiteiliger Dichteinsatz  
Nicht durchgehend isolierend

Two-piece sealing insert  
not overall length insulated

G	> Ø <	> Ø <	> Ø <	> Ø <	mm	H	L1	L	Art.-No.	mm
	min mm	max mm	min mm	max mm		mm	mm	mm		
Pg 11	5.5	8.5	8.5	12.0	27/21	21	40	50	1100.11.50	10
Pg 13	8.0	11.0	11.0	15.0	30/24	23	40	50	1100.13.50	10
Pg 16	8.0	11.0	11.0	15.0	30/24	23	40	50	1100.16.50	10
Pg 21	12.5	16.0	16.0	20.5	38/30	28	40	50	1100.21.50	10
Pg 29	19.0	23.0	23.0	27.5	46/38	28	40	50	1100.29.50	10

Weitere Abmessungen auf Anfrage

Further dimensions upon request



# Kabelverschraubungen Progress® Messing mit speziellem Anschlussgewinde

## Cable glands Progress® nickel-plated brass with special entry thread

### Mit Innengewinde metrisch | With inner thread metric

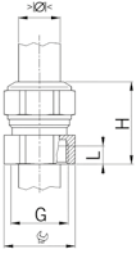

Material: Messing vernickelt  
 Dichtung: TPE  
 Zugentlastung: Ausführung A nach EN 62444  
 Schutzart: IP 68, wenn Anschlussgewinde abgedichtet  
 Einsatztemperatur: -40 °C / +100 °C

Material: Nickel-plated brass  
 Seal: TPE  
 Strain relief: Version A acc. to EN 62444  
 Protection class: IP 68, if the entry thread is sealed  
 Operation temperature: -40 °C / +100 °C



Zweiteiliger Dichteinsatz  
 Nicht durchgehend isolierend

Two-piece sealing insert  
 not overall length insulated

G	> Ø <	> Ø <	> Ø <	> Ø <	mm	H	L	Art.-No.	
	min mm	max mm	min mm	max mm	mm	mm	mm		
<b>M16x1.5</b>	6.0	8.0	8.0	10.5	18	28	6	<b>1400.17</b>	25
<b>M20x1.5</b>	8.0	11.0	11.0	15.0	24	31	6	<b>1400.20</b>	25
<b>M25x1.5</b>	12.5	16.0	16.0	20.5	30	40	10	<b>1400.25</b>	25

Erhältlich mit Dichteinsatz gemäss EN 45545 / NFPA 130. Bei Anfragen oder Bestellung bitte ein F vor die Artikelnummer setzen.

Available with sealing inserts conformity with EN 45545 / NFPA 130. When placing an inquiry, prefix the article number by the capital F.

### Mit Innengewinde Pg | With inner thread Pg

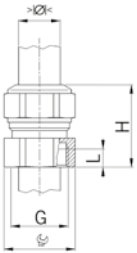

Material: Messing vernickelt  
 Dichtung: TPE  
 Schutzart: IP 68, wenn Anschlussgewinde abgedichtet  
 Einsatztemperatur: -40 °C / +100 °C

Material: Nickel-plated brass  
 Seal: TPE  
 Protection class: IP 68, if the entry thread is sealed  
 Operation temperature: -40 °C / +100 °C



Zweiteiliger Dichteinsatz  
 Nicht durchgehend isolierend

Two-piece sealing insert  
 not overall length insulated

G	> Ø <	> Ø <	> Ø <	> Ø <	mm	H	L	Art.-No.	
	min mm	max mm	min mm	max mm	mm	mm	mm		
<b>Pg 11</b>	5.5	8.5	8.5	12.0	21	28	6	<b>1400.11</b>	25
<b>Pg 16</b>	8.0	11.0	11.0	15.0	24	31	6	<b>1400.16</b>	25
<b>Pg 21</b>	12.5	16.0	16.0	20.5	30	40	10	<b>1400.21</b>	25

Erhältlich mit Dichteinsatz gemäss EN 45545 / NFPA 130. Bei Anfragen oder Bestellung bitte ein F vor die Artikelnummer setzen.

Available with sealing inserts conformity with EN 45545 / NFPA 130. When placing an inquiry, prefix the article number by the capital F.

# Kabelverschraubungen Progress® Messing mit Knickschutztülle EPDM Cable glands Progress® nickel-plated brass with antikink nozzle EPDM

## Kurzes Anschlussgewinde metrisch | Short entry thread metric

Material: Messing vernickelt  
Dichtung: NBR  
O-Ring: NBR  
Knickschutztülle: EPDM  
Zugentlastung: Ausführung A nach EN 62444  
Schutzart: IP 68 / IP 69  
Einsatztemperatur: -40 °C / +100 °C

Material: Nickel-plated brass  
Seal: NBR  
O-ring: NBR  
antikink nozzle: EPDM  
Strain relief: Version A acc. to EN 62444  
Protection class: IP 68 / IP 69  
Operation temperature: -40 °C / +100 °C

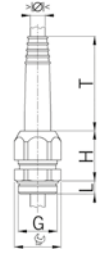

Einteiliger Dichteinsatz  
Nicht durchgehend isolierend

One-piece sealing insert  
not overall length insulated

G	$\varnothing_{\text{min}}$	$\varnothing_{\text{max}}$	$\varnothing_{\text{mm}}$	H	T	L	i	Art.-No.	
	min mm	max mm	mm	mm	mm	mm	info		
<b>M8x1.25</b>	3.8	4.8	11	12	25	6	1	<b>1008.52</b>	50
<b>M10x1.5</b>	4.0	6.0	16	20	35	6	1	<b>1010.52</b>	50
<b>M12x1.5</b>	4.0	6.0	16	20	35	6	-	<b>1012.52</b>	50
<b>M16x1.5</b>	6.0	8.8	20	24	45	6	-	<b>1017.52</b>	50
<b>M20x1.5</b>	9.0	11.0	24	28	65	6	-	<b>1020.51</b>	25
<b>M20x1.5</b>	10.5	13.0	24	28	75	6	-	<b>1020.52</b>	25
<b>M25x1.5</b>	13.0	16.5	32	33	92	7	-	<b>1025.52</b>	10

1 = Metrisches Regelgewinde (mit VDE Testreport)

1 = Metric coarse-pitch thread (with VDE Testreport)



## Kurzes Anschlussgewinde Pg | Short entry thread Pg

Material: Messing vernickelt  
Dichtung: NBR  
O-Ring: NBR  
Knickschutztülle: EPDM  
Schutzart: IP 68 / IP 69  
Einsatztemperatur: -40 °C / +100 °C

Material: Nickel-plated brass  
Seal: NBR  
O-ring: NBR  
antikink nozzle: EPDM  
Protection class: IP 68 / IP 69  
Operation temperature: -40 °C / +100 °C

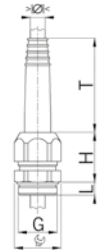

Einteiliger Dichteinsatz  
Nicht durchgehend isolierend

One-piece sealing insert  
not overall length insulated

G	$\varnothing_{\text{min}}$	$\varnothing_{\text{max}}$	$\varnothing_{\text{mm}}$	H	T	L	Art.-No.	
	min mm	max mm	mm	mm	mm	mm		
<b>Pg 7</b>	4.0	6.0	16	20	35	6	<b>1007.52</b>	50
<b>Pg 9</b>	6.0	8.8	20	24	45	6	<b>1009.52</b>	50
<b>Pg 11</b>	6.0	8.8	20	24	45	6	<b>1011.52</b>	50
<b>Pg 13</b>	9.0	11.0	24	28	65	6	<b>1013.51</b>	25
<b>Pg 13</b>	10.5	13.0	24	28	75	6	<b>1013.52</b>	25
<b>Pg 16</b>	9.0	11.0	24	28	65	6	<b>1016.51</b>	25
<b>Pg 16</b>	10.5	13.0	24	28	75	6	<b>1016.52</b>	25
<b>Pg 21</b>	13.0	16.5	32	33	92	7.5	<b>1021.51</b>	10



# Kabelverschraubungen Progress® Messing mit Knickschutzfeder

## Cable glands Progress® nickel-plated brass with antikink spring

### Kurzes Anschlussgewinde metrisch | Short entry thread metric

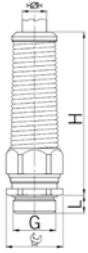

Material: Messing vernickelt  
 Knickschutzfeder: Rostfreier Stahl A2  
 Dichtung: TPE  
 O-Ring: NBR  
 Zugentlastung: Ausführung A nach EN 62444  
 Schutzart: IP 68 (bis 10 bar) / IP 69  
 Einsatztemperatur: -40 °C / +100 °C

Material: Nickel-plated brass  
 Antikink spring: Stainless steel A2  
 Seal: TPE  
 O-ring: NBR  
 Strain relief: Version A acc. to EN 62444  
 Protection class: IP 68 (up to 10 bar) / IP 69  
 Operation temperature: -40 °C / +100 °C



Progress MS FKN



Einteiliger Dichteinsatz  
 Durchgehend isolierend

One-piece sealing insert  
 overall length insulated

G	> Ø <	> Ø <	mm	H	L	i	Art.-No.	
	min mm	max mm	mm	mm	mm	info		
M8x1.25	2.5	3.0	11	49	5	1	1060.08.52.030	10
M8x1.25	3.5	4.0	11	49	5	1	1060.08.52.040	10
M10x1.5	3.0	4.0	13	52	5	1	1060.10.52.040	10
M10x1.5	4.0	6.0	13	52	5	1	1060.10.52.060	10
M12x1.5	3.5	5.0	15	57	5	-	1060.12.52.050	10
M12x1.5	5.0	6.5	15	57	5	-	1060.12.52.065	10
M12x1.5	6.5	7.5	15	57	5	-	1060.12.52.075	10
M16x1.5	4.5	6.0	18	66	5	-	1060.17.52.060	10
M16x1.5	6.0	8.0	18	66	5	-	1060.17.52.080	10
M16x1.5	8.0	10.5	18	66	5	-	1060.17.52.105	10
M20x1.5	6.0	8.0	24	86	6	-	1060.20.52.080	10
M20x1.5	8.0	11.0	24	86	6	-	1060.20.52.110	10
M20x1.5	11.0	14.5	24	86	6	-	1060.20.52.145	10
M25x1.5	9.5	12.5	30	99	7	-	1060.25.52.125	10
M25x1.5	12.5	16.0	30	99	7	-	1060.25.52.160	10
M25x1.5	16.0	19.0	30	99	7	-	1060.25.52.190	10
M32x1.5	17.0	21.0	36	109	8	-	1060.32.52.210	5
M32x1.5	21.0	24.5	36	109	8	-	1060.32.52.245	5

1 = Metrisches Regelgewinde (mit VDE Testreport)  
 Erhältlich mit Dichteinsatz gemäss EN 45545 / NFPA 130. Bei Anfragen oder Bestellung bitte ein F vor die Artikelnummer setzen.  
 Auf Anfrage lieferbar:  
 Kurzes Anschlussgewinde mit kurzem ein- oder zweiteiligem Dichteinsatz.  
 Langes Anschlussgewinde mit kurzem oder durchgehend isolierendem ein- oder zweiteiligem Dichteinsatz.

1 = Metric coarse-pitch thread (with VDE Testreport)  
 Available with sealing inserts conformity with EN 45545 / NFPA 130. When placing an inquiry, prefix the article number by the capital F.  
 Available on request:  
 Short entry thread with short one-piece or two-piece sealing insert.  
 Long entry thread with short or full-length insulating one-piece or two-piece sealing insert.

Zweiteiliger Dichteinsatz  
 Durchgehend isolierend

Two-piece sealing insert  
 overall length insulated

G	> Ø <	> Ø <	> Ø <	> Ø <	mm	H	L	Art.-No.	
	min mm	max mm	min mm	max mm	mm	mm	mm		
M16x1.5	6.0	8.0	8.0	10.5	18	66	5	1060.17.52	10
M20x1.5	8.0	11.0	11.0	14.5	24	86	6	1060.20.52	10
M25x1.5	12.5	16.0	16.0	19.0	30	99	7	1060.25.52	10
M32x1.5	17.0	20.0	20.0	24.5	36	109	8	1060.32.52	5

Erhältlich mit Dichteinsatz gemäss EN 45545 / NFPA 130. Bei Anfragen oder Bestellung bitte ein F vor die Artikelnummer setzen.  
 Auf Anfrage lieferbar:  
 Kurzes Anschlussgewinde mit kurzem ein- oder zweiteiligem Dichteinsatz.  
 Langes Anschlussgewinde mit kurzem oder durchgehend isolierendem ein- oder zweiteiligem Dichteinsatz.

Available with sealing inserts conformity with EN 45545 / NFPA 130. When placing an inquiry, prefix the article number by the capital F.  
 Available on request:  
 Short entry thread with short one-piece or two-piece sealing insert.  
 Long entry thread with short or full-length insulating one-piece or two-piece sealing insert.

# Kabelverschraubungen Progress® Messing mit Knickschutzfeder Cable glands Progress® nickel-plated brass with antikink spring

## Kurzes Anschlussgewinde Pg | Short entry thread Pg

Material: Messing vernickelt  
Knickschutzfeder: Rostfreier Stahl A2  
Dichtung: TPE  
O-Ring: NBR  
Schutzart: IP 68 (bis 10 bar) / IP 69  
Einsatztemperatur: -40 °C / +100 °C

Material: Nickel-plated brass  
Antikink spring: Stainless steel A2  
Seal: TPE  
O-ring: NBR  
Protection class: IP 68 (up to 10 bar) / IP 69  
Operation temperature: -40 °C / +100 °C

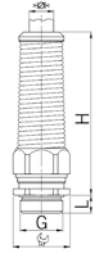

Einteiliger Dichteinsatz  
Durchgehend isolierend

One-piece sealing insert  
overall length insulated

G	>Ø< min mm	>Ø< max mm	Ø mm	H mm	L mm	Art.-No.	
Pg 7	3.5	5.0	15	57	6	1060.07.52.050	10
Pg 7	5.0	6.5	15	57	6	1060.07.52.065	10
Pg 7	6.5	7.5	15	57	6	1060.07.52.075	10
Pg 9	4.5	6.0	18	66	6	1060.09.52.060	10
Pg 9	6.0	8.0	18	66	6	1060.09.52.080	10
Pg 9	8.0	10.5	18	66	6	1060.09.52.105	10
Pg 11	4.5	6.0	18/21	66	6	1060.11.52.060	10
Pg 11	6.0	8.0	18/21	66	6	1060.11.52.080	10
Pg 11	8.0	10.5	18/21	66	6	1060.11.52.105	10
Pg 13	6.0	8.0	24	86	6	1060.13.52.080	10
Pg 13	8.0	11.0	24	86	6	1060.13.52.110	10
Pg 13	11.0	14.5	24	86	6	1060.13.52.145	10
Pg 16	6.0	8.0	24	86	6	1060.16.52.080	10
Pg 16	8.0	11.0	24	86	6	1060.16.52.110	10
Pg 16	11.0	14.5	24	86	6	1060.16.52.145	10
Pg 21	9.5	12.5	30	99	7.5	1060.21.52.125	5
Pg 21	12.5	16.0	30	99	7.5	1060.21.52.160	5
Pg 21	16.0	19.0	30	99	7.5	1060.21.52.190	5

Erhältlich mit Dichteinsatz gemäss EN 45545 / NFPA 130. Bei Anfragen oder Bestellung bitte ein F vor die Artikelnummer setzen.

Available with sealing inserts conformity with EN 45545 / NFPA 130. When placing an inquiry, prefix the article number by the capital F.

Auf Anfrage lieferbar:

Available on request:

Kurzes Anschlussgewinde mit kurzem ein- oder zweiteiligem Dichteinsatz.

Short entry thread with short one-piece or two-piece sealing insert.

Langes Anschlussgewinde mit kurzem oder durchgehend isolierendem ein- oder zweiteiligem Dichteinsatz.

Long entry thread with short or full-length insulating one-piece or two-piece sealing insert.

Zweiteiliger Dichteinsatz  
Durchgehend isolierend

Two-piece sealing insert  
overall length insulated

G	>Ø< min mm	>Ø< max mm	>Ø< min mm	>Ø< max mm	Ø mm	H mm	L mm	Art.-No.	
Pg 9	6.0	8.0	8.0	10.5	18	66	6	1060.09.52	10
Pg 11	6.0	8.0	8.0	10.5	18/21	66	6	1060.11.52	10
Pg 13	8.0	11.0	11.0	14.5	24	86	6	1060.13.52	10
Pg 16	8.0	11.0	11.0	14.5	24	86	6	1060.16.52	10
Pg 21	12.5	16.0	16.0	19.0	30	99	7.5	1060.21.52	5

Erhältlich mit Dichteinsatz gemäss EN 45545 / NFPA 130. Bei Anfragen oder Bestellung bitte ein F vor die Artikelnummer setzen.

Available with sealing inserts conformity with EN 45545 / NFPA 130. When placing an inquiry, prefix the article number by the capital F.

Auf Anfrage lieferbar:

Available on request:

Kurzes Anschlussgewinde mit kurzem ein- oder zweiteiligem Dichteinsatz.

Short entry thread with short one-piece or two-piece sealing insert.

Langes Anschlussgewinde mit kurzem oder durchgehend isolierendem ein- oder zweiteiligem Dichteinsatz.

Long entry thread with short or full-length insulating one-piece or two-piece sealing insert.

1  
2  
3  
4  
5  
6  
7  
8  
9  
10  
11  
12  
13  
14  
15

# Kabelverschraubungen Progress® Messing mit Klemmbacken

## Cable glands Progress® nickel-plated brass with clamps

### Kurzes Anschlussgewinde metrisch | Short entry thread metric

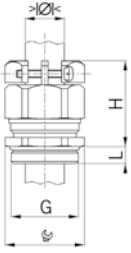

Material: Messing vernickelt  
 Klemmschrauben: Rostfreier Stahl A2  
 Dichtung: TPE  
 O-Ring: NBR  
 Zugentlastung: Ausführung B nach EN 62444  
 Schutzart: IP 68 (bis 10 bar) / IP 69  
 Einsatztemperatur: -40 °C / +100 °C

Material: Nickel-plated brass  
 Screws: Stainless steel A2  
 Seal: TPE  
 O-ring: NBR  
 Strain relief: Version B acc. to EN 62444  
 Protection class: IP 68 (up to 10 bar) / IP 69  
 Operation temperature: -40 °C / +100 °C



Einteiliger Dichteinsatz  
 Nicht durchgehend isolierend

One-piece sealing insert  
 not overall length insulated

G	$\begin{matrix} > \ominus < \\ \text{min mm} \end{matrix}$	$\begin{matrix} > \ominus < \\ \text{max mm} \end{matrix}$	$\begin{matrix} \text{mm} \\ \text{mm} \end{matrix}$	H	L	i	Art.-No.	
M10x1.5	3.0	4.0	13/16	24	5	1	1800.10.03.040	50
M10x1.5	4.0	6.0	13/16	24	5	1	1800.10.03.060	50
M12x1.5	5.0	6.5	15/16	26	5	-	1800.12.03.065	50
M12x1.5	6.5	8.0	15/16	26	5	-	1800.12.03.080	50

1 = Metrisches Regelgewinde (mit VDE Testreport)

1 = Metric coarse-pitch thread (with VDE Testreport)

Erhältlich mit Dichteinsatz gemäss EN 45545 / NFPA 130. Bei Anfragen oder Bestellung bitte ein F vor die Artikelnummer setzen.

Available with sealing inserts conformity with EN 45545 / NFPA 130. When placing an inquiry, prefix the article number by the capital F.

Progress MS KB



Zweiteiliger Dichteinsatz  
 Nicht durchgehend isolierend

Two-piece sealing insert  
 not overall length insulated

G	$\begin{matrix} > \ominus < \\ \text{min mm} \end{matrix}$	$\begin{matrix} > \ominus < \\ \text{max mm} \end{matrix}$	$\begin{matrix} > \ominus < \\ \text{min mm} \end{matrix}$	$\begin{matrix} > \ominus < \\ \text{max mm} \end{matrix}$	$\begin{matrix} \text{mm} \\ \text{mm} \end{matrix}$	H	L	Art.-No.	
M16x1.5	6.0	8.0	8.0	10.5	18/19	30	5	1800.17.03.105	50
M20x1.5	8.0	11.0	11.0	15.0	24	31	6	1800.20.03.150	50
M25x1.5	12.5	16.0	16.0	20.5	30	35	7	1800.25.03.205	25
M32x1.5	17.0	21.0	21.0	25.5	36	40	8	1800.32.03.255	25
M40x1.5	24.0	28.5	28.5	33.0	46	44	8	1800.40.03.330	10
M50x1.5	33.0	37.0	37.0	42.0	55	49	9	1800.50.03.410	10
M63x1.5	40.0	46.0	46.0	52.0	70	55	10	1800.63.03.520	5
M75x1.5	50.0	56.0	56.0	63.0	80	56	11	1800.75.03.630	1

Erhältlich mit Dichteinsatz gemäss EN 45545 / NFPA 130. Bei Anfragen oder Bestellung bitte ein F vor die Artikelnummer setzen.

Available with sealing inserts conformity with EN 45545 / NFPA 130. When placing an inquiry, prefix the article number by the capital F.

# Kabelverschraubungen Progress® Messing mit Klemmbacken

## Cable glands Progress® nickel-plated brass with clamps

### Langes Anschlussgewinde metrisch | Long entry thread metric

Material:	Messing vernickelt	Material:	Nickel-plated brass
Klemmschrauben:	Rostfreier Stahl A2	Screws:	Stainless steel A2
Dichtung:	TPE	Seal:	TPE
O-Ring:	NBR	O-ring:	NBR
Zugentlastung:	Ausführung B nach EN 62444	Strain relief:	Version B acc. to EN 62444
Schutzart:	IP 68 (bis 10 bar) / IP 69	Protection class:	IP 68 (up to 10 bar) / IP 69
Einsatztemperatur:	-40 °C / +100 °C	Operation temperature:	-40 °C / +100 °C

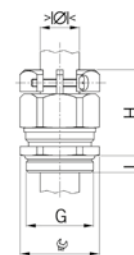

Einteiliger Dichteinsatz  
Nicht durchgehend isolierend

One-piece sealing insert  
not overall length insulated

G	> Ø <	> Ø <	mm	H	L	i	Art.-No.	
	min mm	max mm		mm	mm	info		
M10x1.5	3.0	4.0	13/16	24	10	1	<b>1800.10.13.040</b>	50
M10x1.5	4.0	6.0	13/16	24	10	1	<b>1800.10.13.060</b>	50
M12x1.5	5.0	6.5	15/16	26	10	-	<b>1800.12.13.065</b>	50
M12x1.5	6.5	8.0	15/16	26	10	-	<b>1800.12.13.080</b>	50

1 = Metrisches Regelgewinde (mit VDE Testreport)

1 = Metric coarse-pitch thread (with VDE Testreport)

Erhältlich mit Dichteinsatz gemäss EN 45545 / NFPA 130. Bei Anfragen oder Bestellung bitte ein F vor die Artikelnummer setzen.

Available with sealing inserts conformity with EN 45545 / NFPA 130. When placing an inquiry, prefix the article number by the capital F.



Progress MS KB



Zweiteiliger Dichteinsatz  
Nicht durchgehend isolierend

Two-piece sealing insert  
not overall length insulated

G	> Ø <	> Ø <	> Ø <	> Ø <	mm	H	L	Art.-No.	
	min mm	max mm	min mm	max mm		mm	mm		
M16x1.5	6.0	8.0	8.0	10.5	18/19	30	10	<b>1800.17.13.105</b>	50
M20x1.5	8.0	11.0	11.0	15.0	24	31	10	<b>1800.20.13.150</b>	50
M25x1.5	12.5	16.0	16.0	20.5	30	35	11	<b>1800.25.13.205</b>	25
M32x1.5	17.0	21.0	21.0	25.5	36	40	13	<b>1800.32.13.255</b>	25
M40x1.5	24.0	28.5	28.5	33.0	46	44	13	<b>1800.40.13.330</b>	10
M50x1.5	33.0	37.0	37.0	42.0	55	49	14	<b>1800.50.13.410</b>	10
M63x1.5	40.0	46.0	46.0	52.0	70	55	14	<b>1800.63.13.520</b>	5
M75x1.5	50.0	56.0	56.0	63.0	80	56	15	<b>1800.75.13.630</b>	1

Erhältlich mit Dichteinsatz gemäss EN 45545 / NFPA 130. Bei Anfragen oder Bestellung bitte ein F vor die Artikelnummer setzen.

Available with sealing inserts conformity with EN 45545 / NFPA 130. When placing an inquiry, prefix the article number by the capital F.

# Kabelverschraubungen Progress® Messing mit Klemmbacken

## Cable glands Progress® nickel-plated brass with clamps

### Kurzes Anschlussgewinde Pg | Short entry thread Pg

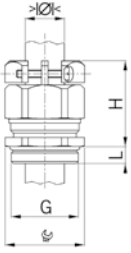

Material: Messing vernickelt  
 Klemmschrauben: Rostfreier Stahl A2  
 Dichtung: TPE  
 O-Ring: NBR  
 Schutzart: IP 68 (bis 10 bar) / IP 69  
 Einsatztemperatur: -40 °C / +100 °C

Material: Nickel-plated brass  
 Screws: Stainless steel A2  
 Seal: TPE  
 O-ring: NBR  
 Protection class: IP 68 (up to 10 bar) / IP 69  
 Operation temperature: -40 °C / +100 °C



Einteiliger Dichteinsatz  
 Nicht durchgehend isolierend

One-piece sealing insert  
 not overall length insulated

**G**  $\begin{matrix} >|\ominus|< \\ \text{min mm} \end{matrix}$   $\begin{matrix} >|\ominus|< \\ \text{max mm} \end{matrix}$   $\begin{matrix} \text{mm} \\ \text{bar} \end{matrix}$  **H** **L**  
 mm mm

Art.-No.



<b>Pg 7</b>	5.0	6.5	15/16	26	6		
<b>Pg 7</b>	6.5	8.0	15/16	26	6		

<b>1800.07.03.065</b>	50
<b>1800.07.03.080</b>	50

Erhältlich mit Dichteinsatz gemäss EN 45545 / NFPA 130.  
 Bei Anfragen oder Bestellung bitte ein F vor die Artikelnummer setzen.

Available with sealing inserts conformity with EN 45545 / NFPA 130. When placing an inquiry, prefix the article number by the capital F.

Zweiteiliger Dichteinsatz  
 Nicht durchgehend isolierend

Two-piece sealing insert  
 not overall length insulated

**G**  $\begin{matrix} >|\ominus|< \\ \text{min mm} \end{matrix}$   $\begin{matrix} >|\ominus|< \\ \text{max mm} \end{matrix}$   $\begin{matrix} >|\ominus|< \\ \text{min mm} \end{matrix}$   $\begin{matrix} >|\ominus|< \\ \text{max mm} \end{matrix}$   $\begin{matrix} \text{mm} \\ \text{bar} \end{matrix}$  **H** **L**  
 mm mm mm mm

Art.-No.



<b>Pg 9</b>	6.0	8.0	8.0	10.5	18/19	30	6
<b>Pg 11</b>	5.5	8.5	8.5	12.0	21	31	6
<b>Pg 13</b>	8.0	11.0	11.0	15.0	24	31	6
<b>Pg 16</b>	8.0	11.0	11.0	15.0	24	31	6
<b>Pg 21</b>	12.5	16.0	16.0	20.5	30	35	7
<b>Pg 29</b>	19.0	23.0	23.0	27.5	38	40	8
<b>Pg 36</b>	26.0	30.5	30.5	35.0	50	47	8
<b>Pg 42</b>	33.0	37.0	37.0	42.0	55	49	10
<b>Pg 48</b>	37.0	43.0	43.0	49.0	65	51	11

<b>1800.09.03.105</b>	50
<b>1800.11.03.120</b>	50
<b>1800.13.03.150</b>	50
<b>1800.16.03.150</b>	50
<b>1800.21.03.205</b>	25
<b>1800.29.03.275</b>	25
<b>1800.36.03.350</b>	10
<b>1800.42.03.410</b>	10
<b>1800.48.03.490</b>	5

Erhältlich mit Dichteinsatz gemäss EN 45545 / NFPA 130.  
 Bei Anfragen oder Bestellung bitte ein F vor die Artikelnummer setzen.

Available with sealing inserts conformity with EN 45545 / NFPA 130. When placing an inquiry, prefix the article number by the capital F.

# Kabelverschraubungen Progress® Messing mit Klemmbacken

## Cable glands Progress® nickel-plated brass with clamps

### Langes Anschlussgewinde Pg | Long entry thread Pg

Material:	Messing vernickelt	Material:	Nickel-plated brass
Klemmschrauben:	Rostfreier Stahl A2	Screws:	Stainless steel A2
Dichtung:	TPE	Seal:	TPE
O-Ring:	NBR	O-ring:	NBR
Schutzart:	IP 68 (bis 10 bar) / IP 69	Protection class:	IP 68 (up to 10 bar) / IP 69
Einsatztemperatur:	-40 °C / +100 °C	Operation temperature:	-40 °C / +100 °C

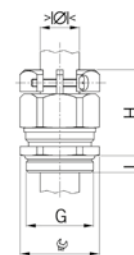

Einteiliger Dichteinsatz  
Nicht durchgehend isolierend

One-piece sealing insert  
not overall length insulated

**G**  $\begin{matrix} >|\ominus|< >|\ominus|< \\ \text{min mm} & \text{max mm} \end{matrix}$   $\begin{matrix} \text{mm} \\ \text{mm} \end{matrix}$  **H** **L**

Art.-No.

<b>Pg 7</b>	5.0	6.5	15/16	26	10
<b>Pg 7</b>	6.5	8.0	15/16	26	10

<b>1800.07.13.065</b>	50
<b>1800.07.13.080</b>	50

Erhältlich mit Dichteinsatz gemäss EN 45545 / NFPA 130. Available with sealing inserts conformity with EN 45545 / NFPA 130. Bei Anfragen oder Bestellung bitte ein F vor die Artikelnummer setzen. When placing an inquiry, prefix the article number by the capital F.



Zweiteiliger Dichteinsatz  
Nicht durchgehend isolierend

Two-piece sealing insert  
not overall length insulated

**G**  $\begin{matrix} >|\ominus|< >|\ominus|< >|\ominus|< >|\ominus|< \\ \text{min mm} & \text{max mm} & \text{min mm} & \text{max mm} \end{matrix}$   $\begin{matrix} \text{mm} \\ \text{mm} \end{matrix}$  **H** **L**

Art.-No.

<b>Pg 9</b>	6.0	8.0	8.0	10.5	18/19	30	10
<b>Pg 11</b>	5.5	8.5	8.5	12.0	21	31	10
<b>Pg 13</b>	8.0	11.0	11.0	15.0	24	31	10
<b>Pg 16</b>	8.0	11.0	11.0	15.0	24	31	10
<b>Pg 21</b>	12.5	16.0	16.0	20.5	30	35	12
<b>Pg 29</b>	19.0	23.0	23.0	27.5	38	40	12
<b>Pg 36</b>	26.0	30.5	30.5	35.0	50	47	15
<b>Pg 42</b>	33.0	37.0	37.0	42.0	55	49	15
<b>Pg 48</b>	37.0	43.0	43.0	49.0	65	51	15

<b>1800.09.13.105</b>	50
<b>1800.11.13.120</b>	50
<b>1800.13.13.150</b>	50
<b>1800.16.13.150</b>	50
<b>1800.21.13.205</b>	25
<b>1800.29.13.275</b>	25
<b>1800.36.13.350</b>	10
<b>1800.42.13.410</b>	10
<b>1800.48.13.490</b>	5

Erhältlich mit Dichteinsatz gemäss EN 45545 / NFPA 130. Available with sealing inserts conformity with EN 45545 / NFPA 130. Bei Anfragen oder Bestellung bitte ein F vor die Artikelnummer setzen. When placing an inquiry, prefix the article number by the capital F.

# Klemmbacken-Stutzen Messing

## Clamp jaw nozzle brass

### Anschlussgewinde metrisch | Entry thread metric

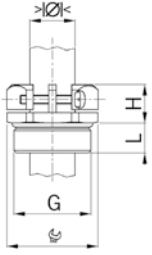

Material: Messing vernickelt  
 Klemmschrauben: Rostfreier Stahl A2  
 Zugentlastung: Ausführung B nach EN 62444  
 Schutzart: IP 20  
 Einsatztemperatur: -50 °C / +300 °C

Material: Nickel-plated brass  
 Screws: Stainless steel A2  
 Strain relief: Version B acc. to EN 62444  
 Protection class: IP 20  
 Operation temperature: -50 °C / +300 °C



#### Mechanische Zugentlastung B

#### Mechanical strain relief B

G	> Ø < min mm	> Ø < max mm	mm	H mm	L mm	Art.-No.	
<b>M12x1.5</b>	5.0	8.0	16	10	10	<b>1812.02</b>	50
<b>M16x1.5</b>	6.0	10.5	19	11	10	<b>1817.02</b>	50
<b>M20x1.5</b>	8.0	15.0	24	12	10	<b>1820.02</b>	50
<b>M25x1.5</b>	12.5	20.5	30	13	11	<b>1825.02</b>	25
<b>M32x1.5</b>	17.0	25.5	36	15	13	<b>1832.02</b>	25
<b>M40x1.5</b>	24.0	33.0	46	17	13	<b>1840.02</b>	10

### Anschlussgewinde Pg | Entry thread Pg

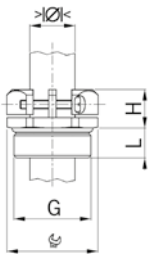

Material: Messing vernickelt  
 Klemmschrauben: Rostfreier Stahl A2  
 Schutzart: IP 20  
 Einsatztemperatur: -50 °C / +300 °C

Material: Nickel-plated brass  
 Screws: Stainless steel A2  
 Protection class: IP 20  
 Operation temperature: -50 °C / +300 °C



#### Mechanische Zugentlastung B

#### Mechanical strain relief B

G	> Ø < min mm	> Ø < max mm	mm	H mm	L mm	Art.-No.	
<b>Pg 7</b>	4.0	8.0	17	10	6	<b>1807.02</b>	50
<b>Pg 9</b>	6.0	10.0	20	11	6	<b>1809.02</b>	50
<b>Pg 11</b>	6.0	12.0	22	11	6	<b>1811.02</b>	50
<b>Pg 13</b>	7.0	15.0	24	11	7	<b>1813.02</b>	50
<b>Pg 16</b>	9.0	17.0	27	12	7	<b>1816.02</b>	50
<b>Pg 21</b>	12.0	22.0	35	14	8	<b>1821.02</b>	25
<b>Pg 29</b>	18.0	30.0	42	15	8	<b>1829.02</b>	25
<b>Pg 36</b>	24.0	36.0	55	18	10	<b>1836.02</b>	10

# Kabelverschraubungen Progress® Messing mit Trompete

## Cable glands Progress® nickel-plated brass with trumpet

### Kurzes Anschlussgewinde metrisch | Short entry thread metric

Material: Messing vernickelt  
 Dichtung: TPE  
 O-Ring: NBR  
 Zugentlastung: Ausführung A nach EN 62444  
 Schutzart: IP 68 (bis 10 bar) / IP 69  
 Einsatztemperatur: -40 °C / +100 °C

Material: Nickel-plated brass  
 Seal: TPE  
 O-ring: NBR  
 Strain relief: Version A acc. to EN 62444  
 Protection class: IP 68 (up to 10 bar) / IP 69  
 Operation temperature: -40 °C / +100 °C

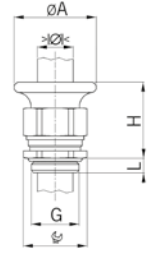

Zweiteiliger Dichteinsatz  
 Nicht durchgehend isolierend

Two-piece sealing insert  
 not overall length insulated

G	min mm	max mm	min mm	max mm	mm	ØA mm	H mm	L mm	Art.-No.	
M16x1.5	6.0	8.0	8.0	10.5	18	28	31	5	1800.10.17	50
M20x1.5	8.0	11.0	11.0	15.0	24	34	32	6	1800.10.20	50
M25x1.5	12.5	16.0	16.0	20.5	30	44	38	7	1800.10.25	25
M32x1.5	17.0	21.0	21.0	25.5	36	50	44	8	1800.10.32	25
M40x1.5	24.0	28.5	28.5	33.0	46	57	46	8	1800.10.40	10

Erhältlich mit Dichteinsatz gemäss EN 45545 / NFPA 130. Bei Anfragen oder Bestellung bitte ein F vor die Artikelnummer setzen.

Available with sealing inserts conformity with EN 45545 / NFPA 130. When placing an inquiry, prefix the article number by the capital F.



Progress MS T



### Langes Anschlussgewinde metrisch | Long entry thread metric

Zweiteiliger Dichteinsatz  
 Nicht durchgehend isolierend

Two-piece sealing insert  
 not overall length insulated

G	min mm	max mm	min mm	max mm	mm	ØA mm	H mm	L mm	Art.-No.	
M16x1.5	6.0	8.0	8.0	10.5	18	28	31	10	1800.11.17	50
M20x1.5	8.0	11.0	11.0	15.0	24	34	32	10	1800.11.20	50
M25x1.5	12.5	16.0	16.0	20.5	30	44	38	11	1800.11.25	25
M32x1.5	17.0	21.0	21.0	25.5	36	50	44	13	1800.11.32	25
M40x1.5	24.0	28.5	28.5	33.0	46	57	46	13	1800.11.40	10

Erhältlich mit Dichteinsatz gemäss EN 45545 / NFPA 130. Bei Anfragen oder Bestellung bitte ein F vor die Artikelnummer setzen.

Available with sealing inserts conformity with EN 45545 / NFPA 130. When placing an inquiry, prefix the article number by the capital F.



Progress MS T



1  
2  
3  
4  
5  
6  
7  
8  
9  
10  
11  
12  
13  
14  
15

# Kabelverschraubungen Progress® Messing mit Trompete

## Cable glands Progress® nickel-plated brass with trumpet

### Kurzes Anschlussgewinde Pg | Short entry thread Pg

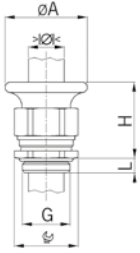

Material: Messing vernickelt  
 Dichtung: TPE  
 O-Ring: NBR  
 Schutzart: IP 68 (bis 10 bar) / IP 69  
 Einsatztemperatur: -40 °C / +100 °C

Material: Nickel-plated brass  
 Seal: TPE  
 O-ring: NBR  
 Protection class: IP 68 (up to 10 bar) / IP 69  
 Operation temperature: -40 °C / +100 °C



Zweiteiliger Dichteinsatz  
 Nicht durchgehend isolierend

Two-piece sealing insert  
 not overall length insulated

G	>Ø< min mm	>Ø< max mm	>Ø< min mm	>Ø< max mm	Ø mm	ØA mm	H mm	L mm	Art.-No.	
<b>Pg 9</b>	6.0	8.0	8.0	10.5	18	28	31	6	<b>1800.10.09</b>	50
<b>Pg 11</b>	5.5	8.5	8.5	12.0	21	30	31	6	<b>1800.10.11</b>	50
<b>Pg 13</b>	8.0	11.0	11.0	15.0	24	34	32	6	<b>1800.10.13</b>	50
<b>Pg 16</b>	8.0	11.0	11.0	15.0	24	34	32	6	<b>1800.10.16</b>	50
<b>Pg 21</b>	12.5	16.0	16.0	20.5	30	44	38	7.5	<b>1800.10.21</b>	25
<b>Pg 29</b>	19.0	23.0	23.0	27.5	38	50	44	8	<b>1800.10.29</b>	10

Erhältlich mit Dichteinsatz gemäss EN 45545 / NFPA 130. Bei Anfragen oder Bestellung bitte ein F vor die Artikelnummer setzen.

Available with sealing inserts conformity with EN 45545 / NFPA 130. When placing an inquiry, prefix the article number by the capital F.

### Langes Anschlussgewinde Pg | Long entry thread Pg



Zweiteiliger Dichteinsatz  
 Nicht durchgehend isolierend

Two-piece sealing insert  
 not overall length insulated

G	>Ø< min mm	>Ø< max mm	>Ø< min mm	>Ø< max mm	Ø mm	ØA mm	H mm	L mm	Art.-No.	
<b>Pg 9</b>	6.0	8.0	8.0	10.5	18	28	31	10	<b>1800.11.09</b>	50
<b>Pg 11</b>	5.5	8.5	8.5	12.0	21	30	31	10	<b>1800.11.11</b>	50
<b>Pg 13</b>	8.0	11.0	11.0	15.0	24	34	32	10	<b>1800.11.13</b>	50
<b>Pg 16</b>	8.0	11.0	11.0	15.0	24	34	32	10	<b>1800.11.16</b>	50
<b>Pg 21</b>	12.5	16.0	16.0	20.5	30	44	38	12	<b>1800.11.21</b>	25
<b>Pg 29</b>	19.0	23.0	23.0	27.5	38	50	44	12	<b>1800.11.29</b>	10

Erhältlich mit Dichteinsatz gemäss EN 45545 / NFPA 130. Bei Anfragen oder Bestellung bitte ein F vor die Artikelnummer setzen.

Available with sealing inserts conformity with EN 45545 / NFPA 130. When placing an inquiry, prefix the article number by the capital F.

# Kabelverschraubungen Progress® Messing mit Trompete und Klemmbacken Cable glands Progress® nickel-plated brass with trumpet and clamps

## Kurzes Anschlussgewinde metrisch | Short entry thread metric

Material: Messing vernickelt  
Klemmschrauben: Rostfreier Stahl A2  
Dichtung: TPE  
O-Ring: NBR  
Zugentlastung: Ausführung B nach EN 62444  
Schutzart: IP 68 (bis 10 bar) / IP 69  
Einsatztemperatur: -40 °C / +100 °C

Material: Nickel-plated brass  
Screws: Stainless steel A2  
Seal: TPE  
O-ring: NBR  
Strain relief: Version B acc. to EN 62444  
Protection class: IP 68 (up to 10 bar) / IP 69  
Operation temperature: -40 °C / +100 °C

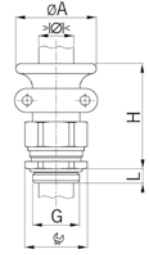

Zweiteiliger Dichteinsatz  
Nicht durchgehend isolierend

Two-piece sealing insert  
not overall length insulated

G	>Ø< min mm	>Ø< max mm	>Ø< min mm	>Ø< max mm	mm	ØA mm	H mm	L mm	Art.-No.	
M16x1.5	6.0	8.0	8.0	10.5	18	28	43	5	1801.10.17	50
M20x1.5	8.0	11.0	11.0	15.0	24	34	46	6	1801.10.20	50
M25x1.5	12.5	16.0	16.0	20.5	30	44	52	7	1801.10.25	25
M32x1.5	17.0	21.0	21.0	25.5	36	50	59	8	1801.10.32	10
M40x1.5	24.0	28.5	28.5	33.0	46	57	59	8	1801.10.40	5

Erhältlich mit Dichteinsatz gemäss EN 45545 / NFPA 130.  
Bei Anfragen oder Bestellung bitte ein F vor die Artikelnummer setzen.

Available with sealing inserts conformity with EN 45545 / NFPA 130. When placing an inquiry, prefix the article number by the capital F.



Progress MS T+KB



## Langes Anschlussgewinde metrisch | Long entry thread metric

Zweiteiliger Dichteinsatz  
Nicht durchgehend isolierend

Two-piece sealing insert  
not overall length insulated

G	>Ø< min mm	>Ø< max mm	>Ø< min mm	>Ø< max mm	mm	ØA mm	H mm	L mm	Art.-No.	
M16x1.5	6.0	8.0	8.0	10.5	18	28	43	10	1801.11.17	50
M20x1.5	8.0	11.0	11.0	15.0	24	34	46	10	1801.11.20	50
M25x1.5	12.5	16.0	16.0	20.5	30	44	52	11	1801.11.25	25
M32x1.5	17.0	21.0	21.0	25.5	36	50	59	13	1801.11.32	10
M40x1.5	24.0	28.5	28.5	33.0	46	57	59	13	1801.11.40	5

Erhältlich mit Dichteinsatz gemäss EN 45545 / NFPA 130.  
Bei Anfragen oder Bestellung bitte ein F vor die Artikelnummer setzen.

Available with sealing inserts conformity with EN 45545 / NFPA 130. When placing an inquiry, prefix the article number by the capital F.



Progress MS T+KB



# Kabelverschraubungen Progress® Messing mit Trompete und Klemmbacken

## Cable glands Progress® nickel-plated brass with trumpet and clamps

### Kurzes Anschlussgewinde Pg | Short entry thread Pg

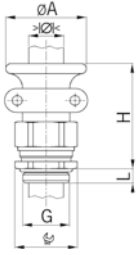

Material: Messing vernickelt  
 Klemmschrauben: Rostfreier Stahl A2  
 Dichtung: TPE  
 O-Ring: NBR  
 Schutzart: IP 68 (bis 10 bar) / IP 69  
 Einsatztemperatur: -40 °C / +100 °C

Material: Nickel-plated brass  
 Screws: Stainless steel A2  
 Seal: TPE  
 O-ring: NBR  
 Protection class: IP 68 (up to 10 bar) / IP 69  
 Operation temperature: -40 °C / +100 °C



Zweiteiliger Dichteinsatz  
 Nicht durchgehend isolierend

Two-piece sealing insert  
 not overall length insulated

G	> Ø < min mm	> Ø < max mm	> Ø < min mm	> Ø < max mm	mm	ØA mm	H mm	L mm	Art.-No.	
<b>Pg 9</b>	6.0	8.0	8.0	10.5	18	28	43	6	<b>1801.10.09</b>	50
<b>Pg 11</b>	5.5	8.5	8.5	12.0	21	30	43	6	<b>1801.10.11</b>	50
<b>Pg 13</b>	8.0	11.0	11.0	15.0	24	34	46	6	<b>1801.10.13</b>	50
<b>Pg 16</b>	8.0	11.0	11.0	15.0	24	34	46	6	<b>1801.10.16</b>	50
<b>Pg 21</b>	12.5	16.0	16.0	20.5	30	44	52	7.5	<b>1801.10.21</b>	25
<b>Pg 29</b>	19.0	23.0	23.0	27.5	38	50	59	8	<b>1801.10.29</b>	10

Erhältlich mit Dichteinsatz gemäss EN 45545 / NFPA 130.  
 Bei Anfragen oder Bestellung bitte ein F vor die Artikelnummer setzen.

Available with sealing inserts conformity with EN 45545 / NFPA 130. When placing an inquiry, prefix the article number by the capital F.

### Langes Anschlussgewinde Pg | Long entry thread Pg



Zweiteiliger Dichteinsatz  
 Nicht durchgehend isolierend





Two-piece sealing insert  
 not overall length insulated

G	> Ø < min mm	> Ø < max mm	> Ø < min mm	> Ø < max mm	mm	ØA mm	H mm	L mm	Art.-No.	
<b>Pg 9</b>	6.0	8.0	8.0	10.5	18	28	43	10	<b>1801.11.09</b>	50
<b>Pg 11</b>	5.5	8.5	8.5	12.0	21	30	43	10	<b>1801.11.11</b>	50
<b>Pg 13</b>	8.0	11.0	11.0	15.0	24	34	46	10	<b>1801.11.13</b>	50
<b>Pg 16</b>	8.0	11.0	11.0	15.0	24	34	46	10	<b>1801.11.16</b>	50
<b>Pg 21</b>	12.5	16.0	16.0	20.5	30	44	52	12	<b>1801.11.21</b>	25
<b>Pg 29</b>	19.0	23.0	23.0	27.5	38	50	59	12	<b>1801.11.29</b>	10

Erhältlich mit Dichteinsatz gemäss EN 45545 / NFPA 130.  
 Bei Anfragen oder Bestellung bitte ein F vor die Artikelnummer setzen.

Available with sealing inserts conformity with EN 45545 / NFPA 130. When placing an inquiry, prefix the article number by the capital F.



Kabelverschraubungen Progress® rostfreier Stahl A2 Cable glands Progress® stainless steel A2		<b>62 - 63</b>
Kabelverschraubungen Progress® rostfreier Stahl A2 für hohe Temperaturen Cable glands Progress® stainless steel A2 for high temperature applications		<b>64 - 65</b>
Kabelverschraubungen Progress® rostfreier und säurebeständiger Stahl A4 für hohe Temperaturen Cable glands Progress® stainless and acid-resistant steel A4 for high temperature applications		<b>66 - 67</b>
Kabelverschraubungen Progress® aqua rostfreier Stahl A2 für Trinkwasser Cable glands Progress® aqua stainless steel A2 for drinking water		<b>68</b>

1

2

3

4

5

6

7

8

9

10

11

12

13

14

15

# Kabelverschraubungen Progress® aus rostfreiem Stahl

## Progress® cable glands of stainless steel

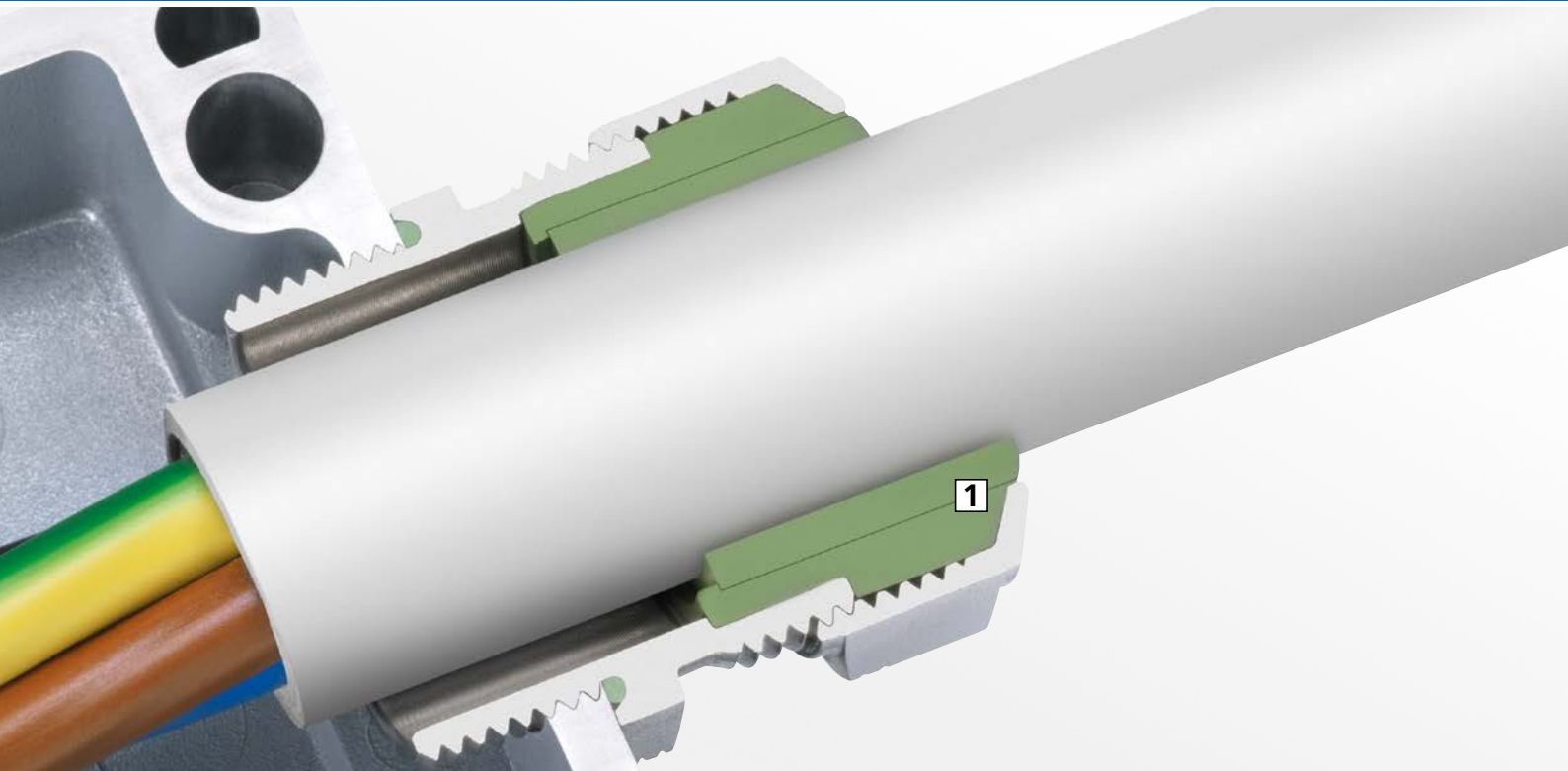

**AGRO Kabelverschraubungen Progress® aus rostfreiem Stahl** weisen eine hohe Korrosionsbeständigkeit und Langlebigkeit auf. Sie sind prädestiniert für den erschwerten Einsatz in der Lebensmittel sowie chemischen Industrie oder auch an Orten mit besonderen Umweltbedingungen wie z.B. in Tunneln oder auf hoher See.

Rostfreie Stähle werden durch die zugeordnete Werkstoffnummer eindeutig spezifiziert. AGRO verwendet für die Kabelverschraubungen den rostfreien Stahl A2 mit der Werkstoffnummer 1.4305 (AISI 303) und für den rostfreien und säurebeständigen Stahl A4 den Werkstoff 1.4435 (AISI 316L).

### 1 Garantierte Dichtigkeit

Auf den Dichteinsatz abgestimmte Innenkonturen sorgen für eine zielgerichtete Verformung des Dichteinsatzes und garantieren somit dessen perfekte Abdichtung. Die Schutzart IP 68 bis 10 bar sowie IP 69 ermöglichen eine breite Anwendung.

**AGRO's Progress® cable glands of stainless steel** are highly corrosion-resistant and extremely durable. They are ideal for challenging applications in the food or chemical industries, or for demanding environmental conditions such as in tunnels or offshore locations.

Stainless steels are clearly specified by the allocated material number. For cable glands, AGRO uses stainless steel of type A2 with the material number 1.4305 (AISI 303), or of type A4 (acid-resistant) with the material number 1.4435 (AISI 316L).

### 1 Absolutely reliable sealing performance

Inner contours precisely matching the sealing insert ensure appropriate deformation of the sealing insert and thus excellent sealing performance. Protection classes IP 68 (up to 10 bar) and IP 69 make it suitable for a wide range of applications.

## Kennzeichnung Stahltyp

### Identification markings for steel type

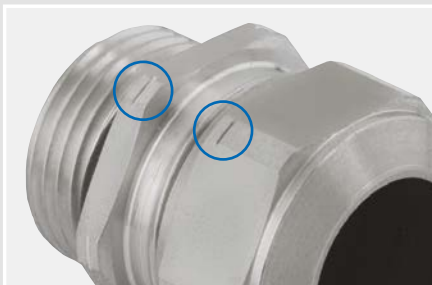

**1 Rille** kennzeichnet **Stahl A2**.  
Dichteinsatz in TPE (schwarz)

**1 groove** identifies **A2 steel**.  
Here: Sealing insert of type TPE (black).



**1 Rille** kennzeichnet **Stahl A2**.  
Dichteinsatz in FPM (grün) für hohe Temperaturen

**1 groove** identifies **A2 steel**.  
Here: Sealing insert of type FPM (green) for high-temperature applications.



**2 Rillen** kennzeichnen **Stahl A4**.  
Dichteinsatz in FPM für hohe Temperaturen und Säurebeständigkeit (grün)

**2 grooves** identify **A4 steel**.  
Here: Sealing insert of type FPM (green) for high temperatures and resistance to acids.

	Progress® Serie Progress® series	Rostfreier Stahl A2 Stainless steel (A2)	Rostfreier Stahl A2 hohe Temperaturen Stainless steel (A2) high temperatures	Rostfreier & säure- beständiger Stahl A4 hohe Temperaturen Stainless and acid- resistant steel (A4), high temperatures	Progress® aqua rostfreier Stahl A2 für Trinkwasser Progress® aqua stainless steel (A2) for drinking water
<b>Ausführung / Type</b>					
Kompressionstechnik Compression technology		•	•	•	•
<b>Gewinde / Thread</b>					
Anschlussgewinde metrisch Metric entry thread		•	•	•	•
Anschlussgewinde Pg PG entry thread		•	•	•	-
Langes Anschlussgewinde Long entry thread		•	•	•	•
Kurzes Anschlussgewinde (Standard) Short entry thread (standard)		A	A	A	A
<b>Dichteinsatz / Sealing insert</b>					
Für Rundkabel For round cables		•	•	•	•
Für mehrere Kabel (Multi-Dichteinsatz) For multiple cables (Multi sealing insert)		A	A	A	A
Dichteinsatz ohne Bohrung Sealing insert without hole		A	A	A	-
Einteiliger Dichteinsatz One-piece sealing insert		•	•	•	•
Zweiteiliger Dichteinsatz Two-piece sealing insert		•	•	•	-
Dichteinsatz für EN 45545 Sealing insert for EN 45545		•	-	A	-
Dichteinsatz EPDM (SVGW zertifiziert) EPDM sealing insert (SVGW-certified)		-	-	-	•
<b>Technische Besonderheiten / Technical characteristics</b>					
Hohe Säurebeständigkeit Highly acid-resistant		-	-	•	-
<b>Material / Material</b>					
Rostfreier Stahl A2 Stainless steel of type A2		•	•	-	•
Rostfreier Stahl A4 Stainless steel of type A4		-	-	•	-

A = Auf Anfrage / A = upon request

# Kabelverschraubungen Progress® rostfreier Stahl A2

## Cable glands Progress® stainless steel A2

### Langes Anschlussgewinde metrisch | Long entry thread metric

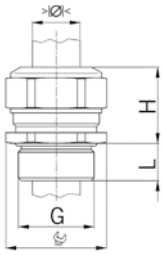

Material: Rostfreier CrNi-Stahl A2 (DIN EN 1.4305 / AISI 303)  
 Kennzeichnung: 1 Rille  
 Dichtung: TPE  
 O-Ring: NBR  
 Zugentlastung: Ausführung A nach EN 62444  
 Schutzart: IP 68 (bis 10 bar) / IP 69  
 Einsatztemperatur: -40 °C / +100 °C

Material: CrNi stainless steel A2 (DIN EN 1.4305 / AISI 303)  
 Identification: 1 groove  
 Seal: TPE  
 O-ring: NBR  
 Strain relief: Version A acc. to EN 62444  
 Protection class: IP 68 (up to 10 bar) / IP 69  
 Operation temperature: -40 °C / +100 °C



Progress S2



Einteiliger Dichteinsatz  
Nicht durchgehend isolierend

One-piece sealing insert  
not overall length insulated

G	> Ø < min mm	> Ø < max mm	mm	H mm	L mm	i info	Art.-No.	
M8x1.25	2.5	3.5	11	14	10	1	1100.08.94.035	50
M8x1.25	3.5	5.0	11	14	10	1	1100.08.94.050	50
M10x1.5	3.0	4.0	13	15	10	1	1100.10.94.040	50
M10x1.5	4.0	6.0	13	15	10	1	1100.10.94.060	50
M12x1.5	3.5	5.0	17	17	10	-	1100.12.94.050	50
M12x1.5	5.0	6.5	17	17	10	-	1100.12.94.065	50
M12x1.5	6.5	8.0	17	17	10	-	1100.12.94.080	50
M16x1.5	8.0	10.5	19	20	10	-	1100.17.94.105	50
M20x1.5	11.0	15.0	24	21	10	-	1100.20.94.150	50
M25x1.5	16.0	20.5	30	25	11	-	1100.25.94.205	25
M32x1.5	21.0	25.5	36	28	13	-	1100.32.94.255	25
M40x1.5	28.5	33.0	46	31	13	-	1100.40.94.330	10
M50x1.5	37.0	42.0	55	34	14	-	1100.50.94.420	10
M63x1.5	46.0	52.0	70	37	14	-	1100.63.94.520	5

1 = Metrisches Regelgewinde (mit VDE Testreport)

1 = Metric coarse-pitch thread (with VDE test report)

Erhältlich mit Dichteinsatz gemäss EN 45545 / NFPA 130. Bei Anfragen oder Bestellung bitte ein F vor die Artikelnummer setzen.

Available with sealing inserts conformity with EN 45545 / NFPA 130. When placing an inquiry, prefix the article number by the capital F.

Zweiteiliger Dichteinsatz  
Nicht durchgehend isolierend

Two-piece sealing insert  
not overall length insulated

G	> Ø < min mm	> Ø < max mm	> Ø < min mm	> Ø < max mm	mm	H mm	L mm	Art.-No.	
M16x1.5	6.0	8.0	8.0	10.5	19	20	10	1100.17.94	50
M20x1.5	8.0	11.0	11.0	15.0	24	21	10	1100.20.94	50
M25x1.5	12.5	16.0	16.0	20.5	30	25	11	1100.25.94	25
M32x1.5	17.0	21.0	21.0	25.5	36	28	13	1100.32.94	25
M40x1.5	24.0	28.5	28.5	33.0	46	31	13	1100.40.94	10
M50x1.5	33.0	37.0	37.0	42.0	55	34	14	1100.50.94	10
M63x1.5	40.0	46.0	46.0	52.0	70	37	14	1100.63.94	5

Erhältlich mit Dichteinsatz gemäss EN 45545 / NFPA 130. Bei Anfragen oder Bestellung bitte ein F vor die Artikelnummer setzen.

Available with sealing inserts conformity with EN 45545 / NFPA 130. When placing an inquiry, prefix the article number by the capital F.

### Langes Anschlussgewinde Pg | Long entry thread Pg

Material: Rostfreier CrNi-Stahl A2 (DIN EN 1.4305 / AISI 303)  
 Kennzeichnung: 1 Rille  
 Dichtung: TPE  
 O-Ring: NBR  
 Schutzart: IP 68 (bis 10 bar) / IP 69  
 Einsatztemperatur: -40 °C / +100 °C

Material: CrNi stainless steel A2 (DIN EN 1.4305 / AISI 303)  
 Identification: 1 groove  
 Seal: TPE  
 O-ring: NBR  
 Protection class: IP 68 (up to 10 bar) / IP 69  
 Operation temperature: -40 °C / +100 °C

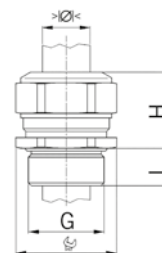

Einteiliger Dichteinsatz  
 Nicht durchgehend isolierend

One-piece sealing insert  
 not overall length insulated

G	>Ø< min mm	>Ø< max mm	Ø mm	H mm	L mm	Art.-No.	
Pg 7	3.5	5.0	17	17	10	1100.07.94.050	50
Pg 7	5.0	6.5	17	17	10	1100.07.94.065	50
Pg 7	6.5	8.0	17	17	10	1100.07.94.080	50
Pg 9	8.0	10.5	19	20	10	1100.09.94.105	50
Pg 11	8.5	12.0	22	21	10	1100.11.94.120	50
Pg 13	11.0	15.0	24	21	10	1100.13.94.150	50
Pg 16	11.0	15.0	24	21	10	1100.16.94.150	50
Pg 21	16.0	20.5	30	25	12	1100.21.94.205	25
Pg 29	23.0	27.5	41	28	12	1100.29.94.275	25
Pg 36	30.5	35.0	50	32	15	1100.36.94.350	10
Pg 42	37.0	42.0	55	34	15	1100.42.94.420	10
Pg 48	43.0	49.0	65	37	15	1100.48.94.490	10

Erhältlich mit Dichteinsatz gemäss EN 45545 / NFPA 130. Available with sealing inserts conformity with EN 45545 / NFPA 130. Bei Anfragen oder Bestellung bitte ein F vor die Artikelnummer setzen. When placing an inquiry, prefix the article number by the capital F.



Zweiteiliger Dichteinsatz  
 Nicht durchgehend isolierend

Two-piece sealing insert  
 not overall length insulated

G	>Ø< min mm	>Ø< max mm	>Ø< min mm	>Ø< max mm	Ø mm	H mm	L mm	Art.-No.	
Pg 9	6.0	8.0	8.0	10.5	19	20	10	1100.09.94	50
Pg 11	5.5	8.5	8.5	12.0	21	21	10	1100.11.94	50
Pg 13	8.0	11.0	11.0	15.0	24	21	10	1100.13.94	50
Pg 16	8.0	11.0	11.0	15.0	24	21	10	1100.16.94	50
Pg 21	12.5	16.0	16.0	20.5	30	25	12	1100.21.94	25
Pg 29	19.0	23.0	23.0	27.5	41	28	12	1100.29.94	25
Pg 36	26.0	30.5	30.5	35.0	50	32	15	1100.36.94	10
Pg 42	33.0	37.0	37.0	42.0	55	34	15	1100.42.94	10
Pg 48	37.0	43.0	43.0	49.0	65	37	15	1100.48.94	10

Erhältlich mit Dichteinsatz gemäss EN 45545 / NFPA 130. Available with sealing inserts conformity with EN 45545 / NFPA 130. Bei Anfragen oder Bestellung bitte ein F vor die Artikelnummer setzen. When placing an inquiry, prefix the article number by the capital F.

# Kabelverschraubungen Progress® rostfreier Stahl A2 für hohe Temperaturen Cable glands Progress® stainless steel A2 for high temperature applications

## Langes Anschlussgewinde metrisch | Long entry thread metric

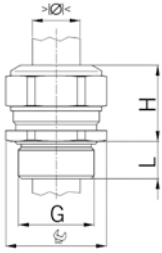

Material: Rostfreier CrNi-Stahl A2 (DIN EN 1.4305 / AISI 303)  
 Kennzeichnung: 1 Rille  
 Dichtung: FPM  
 O-Ring: FPM  
 Zugentlastung: Ausführung A nach EN 62444  
 Schutzart: IP 68 (bis 10 bar) / IP 69  
 Einsatztemperatur: -40 °C / +200 °C

Material: CrNi stainless steel A2 (DIN EN 1.4305 / AISI 303)  
 Identification: 1 groove  
 Seal: FPM  
 O-ring: FPM  
 Strain relief: Version A acc. to EN 62444  
 Protection class: IP 68 (up to 10 bar) / IP 69  
 Operation temperature: -40 °C / +200 °C



Progress S2 HT



Einteiliger Dichteinsatz  
Nicht durchgehend isolierend

One-piece sealing insert  
not overall length insulated

G	> < min mm	> < max mm	> < mm	H mm	L mm	i info	Art.-No.	
M8x1.25	2.5	3.5	11	14	10	1	1100.08.96.035	50
M8x1.25	3.5	5.0	11	14	10	1	1100.08.96.050	50
M10x1.5	3.0	4.0	13	15	10	1	1100.10.96.040	50
M10x1.5	4.0	6.0	13	15	10	1	1100.10.96.060	50
M12x1.5	3.5	5.0	17	17	10	-	1100.12.96.050	50
M12x1.5	5.0	6.5	17	17	10	-	1100.12.96.065	50
M12x1.5	6.5	8.0	17	17	10	-	1100.12.96.080	50
M16x1.5	8.0	10.5	19	20	10	-	1100.17.96.105	50
M20x1.5	11.0	15.0	24	21	10	-	1100.20.96.150	50
M25x1.5	16.0	20.5	30	25	11	-	1100.25.96.205	25
M32x1.5	21.0	25.5	36	28	13	-	1100.32.96.255	25
M40x1.5	28.5	33.0	46	31	13	-	1100.40.96.330	10
M50x1.5	37.0	42.0	55	34	14	-	1100.50.96.420	10
M63x1.5	46.0	52.0	70	37	14	-	1100.63.96.520	5

1 = Metrisches Regelgewinde (mit VDE Testreport)

1 = Metric coarse-pitch thread (with VDE test report)

Zweiteiliger Dichteinsatz  
Nicht durchgehend isolierend

Two-piece sealing insert  
not overall length insulated

G	> < min mm	> < max mm	> < min mm	> < max mm	> < mm	H mm	L mm	Art.-No.	
M16x1.5	6.0	8.0	8.0	10.5	19	20	10	1100.17.96	50
M20x1.5	8.0	11.0	11.0	15.0	24	21	10	1100.20.96	50
M25x1.5	12.5	16.0	16.0	20.5	30	25	11	1100.25.96	25
M32x1.5	17.0	21.0	21.0	25.5	36	28	13	1100.32.96	25
M40x1.5	24.0	28.5	28.5	33.0	46	31	13	1100.40.96	10
M50x1.5	33.0	37.0	37.0	42.0	55	34	14	1100.50.96	10
M63x1.5	40.0	46.0	46.0	52.0	70	37	14	1100.63.96	5

# Kabelverschraubungen Progress® rostfreier Stahl A2 für hohe Temperaturen

## Cable glands Progress® stainless steel A2 for high temperature applications

### Langes Anschlussgewinde Pg | Long entry thread Pg

Material: Rostfreier CrNi-Stahl A2 (DIN EN 1.4305 / AISI 303)  
 Kennzeichnung: 1 Rille  
 Dichtung: FPM  
 O-Ring: FPM  
 Schutzart: IP 68 (bis 10 bar) / IP 69  
 Einsatztemperatur: -40 °C / +200 °C

Material: CrNi stainless steel A2 (DIN EN 1.4305 / AISI 303)  
 Identification: 1 groove  
 Seal: FPM  
 O-ring: FPM  
 Protection class: IP 68 (up to 10 bar) / IP 69  
 Operation temperature: -40 °C / +200 °C

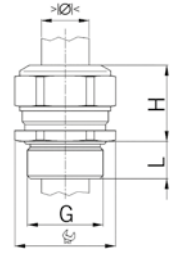

Einteiliger Dichteinsatz  
 Nicht durchgehend isolierend

One-piece sealing insert  
 not overall length insulated

G	>Ø< min mm	>Ø< max mm	Ø mm	H mm	L mm	Art.-No.	
Pg 7	3.5	5.0	17	17	10	1100.07.96.050	50
Pg 7	5.0	6.5	17	17	10	1100.07.96.065	50
Pg 7	6.5	8.0	17	17	10	1100.07.96.080	50
Pg 9	8.0	10.5	19	20	10	1100.09.96.105	50
Pg 11	8.5	12.0	22	21	10	1100.11.96.120	50
Pg 13	11.0	15.0	24	21	10	1100.13.96.150	50
Pg 16	11.0	15.0	24	21	10	1100.16.96.150	50
Pg 21	16.0	20.5	30	25	12	1100.21.96.205	25
Pg 29	23.0	27.5	41	28	12	1100.29.96.275	25
Pg 36	30.5	35.0	50	32	15	1100.36.96.350	10
Pg 42	37.0	42.0	55	34	15	1100.42.96.420	10
Pg 48	43.0	49.0	65	37	15	1100.48.96.490	10

Zweiteiliger Dichteinsatz  
 Nicht durchgehend isolierend

Two-piece sealing insert  
 not overall length insulated

G	>Ø< min mm	>Ø< max mm	>Ø< min mm	>Ø< max mm	Ø mm	H mm	L mm	Art.-No.	
Pg 9	6.0	8.0	8.0	10.5	19	20	10	1100.09.96	50
Pg 11	5.5	8.5	8.5	12.0	22	21	10	1100.11.96	50
Pg 13	8.0	11.0	11.0	15.0	24	21	10	1100.13.96	50
Pg 16	8.0	11.0	11.0	15.0	24	21	10	1100.16.96	50
Pg 21	12.5	16.0	16.0	20.5	30	25	12	1100.21.96	25
Pg 29	19.0	23.0	23.0	27.5	41	28	12	1100.29.96	25
Pg 36	26.0	30.5	30.5	35.0	50	32	15	1100.36.96	10
Pg 42	33.0	37.0	37.0	42.0	55	34	15	1100.42.96	10
Pg 48	37.0	43.0	43.0	49.0	65	37	15	1100.48.96	10

Langes Anschlussgewinde metrisch | Long entry thread metric

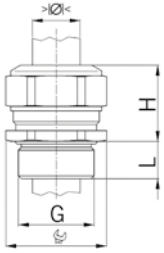

Material: Rostfreier und säurebeständiger CrNiMo-Stahl A4 (DIN EN 1.4435 / AISI 316L)  
 Kennzeichnung: 2 Rillen  
 Dichtung: FPM  
 O-Ring: FPM  
 Zugentlastung: Ausführung A nach EN 62444  
 Schutzart: IP 68 (bis 10 bar) / IP 69  
 Einsatztemperatur: -40 °C / +200 °C

Material: Stainless steel and acid resistant steel A4 CrNiMo (DIN EN 1.4435 / AISI 316L)  
 Identification: 2 grooves  
 Seal: FPM  
 O-ring: FPM  
 Strain relief: Version A acc. to EN 62444  
 Protection class: IP 68 (up to 10 bar) / IP 69  
 Operation temperature: -40 °C / +200 °C



Progress S4 HT



Einteiliger Dichteinsatz  
 Nicht durchgehend isolierend

One-piece sealing insert  
 not overall length insulated

G	> Ø < min mm	> Ø < max mm	mm	H mm	L mm	i info	Art.-No.	
M8x1.25	2.5	3.5	11	14	10	1	1100.08.98.035	50
M8x1.25	3.5	5.0	11	14	10	1	1100.08.98.050	50
M10x1.5	3.0	4.0	13	15	10	1	1100.10.98.040	50
M10x1.5	4.0	6.0	13	15	10	1	1100.10.98.060	50
M12x1.5	3.5	5.0	17	17	10	-	1100.12.98.050	50
M12x1.5	5.0	6.5	17	17	10	-	1100.12.98.065	50
M12x1.5	6.5	8.0	17	17	10	-	1100.12.98.080	50
M16x1.5	8.0	10.5	19	20	10	-	1100.17.98.105	50
M20x1.5	11.0	15.0	24	21	10	-	1100.20.98.150	50
M25x1.5	16.0	20.5	30	25	11	-	1100.25.98.205	25
M32x1.5	21.0	25.5	36	28	13	-	1100.32.98.255	25
M40x1.5	28.5	33.0	46	31	13	-	1100.40.98.330	10
M50x1.5	37.0	42.0	55	34	14	-	1100.50.98.420	10
M63x1.5	46.0	52.0	70	37	14	-	1100.63.98.520	5

1 = Metrisches Regelgewinde (mit VDE Testreport)

1 = Metric coarse-pitch thread (with VDE test report)

Zweiteiliger Dichteinsatz  
 Nicht durchgehend isolierend

Two-piece sealing insert  
 not overall length insulated

G	> Ø < min mm	> Ø < max mm	> Ø < min mm	> Ø < max mm	mm	H mm	L mm	Art.-No.	
M16x1.5	6.0	8.0	8.0	10.5	19	20	10	1100.17.98	50
M20x1.5	8.0	11.0	11.0	15.0	24	21	10	1100.20.98	50
M25x1.5	12.5	16.0	16.0	20.5	30	25	11	1100.25.98	25
M32x1.5	17.0	21.0	21.0	25.5	36	28	13	1100.32.98	25
M40x1.5	24.0	28.5	28.5	33.0	46	31	13	1100.40.98	10
M50x1.5	33.0	37.0	37.0	42.0	55	34	14	1100.50.98	10
M63x1.5	40.0	46.0	46.0	52.0	70	37	14	1100.63.98	5

Langes Anschlussgewinde Pg | Long entry thread Pg

Material: Rostfreier und säurebeständiger CrNiMo-Stahl A4 (DIN EN 1.4435 / AISI 316L)  
 Kennzeichnung: 2 Rillen  
 Dichtung: FPM  
 O-Ring: FPM  
 Schutzart: IP 68 (bis 10 bar) / IP 69  
 Einsatztemperatur: -40 °C / +200 °C

Material: Stainless steel and acid resistant steel A4 CrNiMo (DIN EN 1.4435 / AISI 316L)  
 Identification: 2 grooves  
 Seal: FPM  
 O-ring: FPM  
 Protection class: IP 68 (up to 10 bar) / IP 69  
 Operation temperature: -40 °C / +200 °C

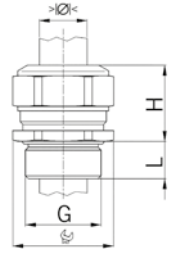

Einteiliger Dichteinsatz  
 Nicht durchgehend isolierend

One-piece sealing insert  
 not overall length insulated

G	>Ø< min mm	>Ø< max mm	Ø mm	H mm	L mm	Art.-No.	
Pg 7	3.5	5.0	17	17	10	1100.07.98.050	50
Pg 7	5.0	6.5	17	17	10	1100.07.98.065	50
Pg 7	6.5	8.0	17	17	10	1100.07.98.080	50
Pg 9	8.0	10.5	19	20	10	1100.09.98.105	50
Pg 11	8.5	12.0	22	21	10	1100.11.98.120	50
Pg 13	11.0	15.0	24	21	10	1100.13.98.150	50
Pg 16	11.0	15.0	24	21	10	1100.16.98.150	50
Pg 21	16.0	20.5	30	25	12	1100.21.98.205	25
Pg 29	23.0	27.5	41	28	12	1100.29.98.275	25
Pg 36	30.5	35.0	50	32	15	1100.36.98.350	10
Pg 42	37.0	42.0	55	34	15	1100.42.98.420	10
Pg 48	43.0	49.0	65	37	15	1100.48.98.490	10



Zweiteiliger Dichteinsatz  
 Nicht durchgehend isolierend

Two-piece sealing insert  
 not overall length insulated

G	>Ø< min mm	>Ø< max mm	>Ø< min mm	>Ø< max mm	Ø mm	H mm	L mm	Art.-No.	
Pg 9	6.0	8.0	8.0	10.5	19	20	10	1100.09.98	50
Pg 11	5.5	8.5	8.5	12.0	22	21	10	1100.11.98	50
Pg 13	8.0	11.0	11.0	15.0	24	21	10	1100.13.98	50
Pg 16	8.0	11.0	11.0	15.0	24	21	10	1100.16.98	50
Pg 21	12.5	16.0	16.0	20.5	30	25	12	1100.21.98	25
Pg 29	19.0	23.0	23.0	27.5	41	28	12	1100.29.98	25
Pg 36	26.0	30.5	30.5	35.0	50	32	15	1100.36.98	10
Pg 42	33.0	37.0	37.0	42.0	55	34	15	1100.42.98	10
Pg 48	37.0	43.0	43.0	49.0	65	37	15	1100.48.98	10

1  
2  
3  
4  
5  
6  
7  
8  
9  
10  
11  
12  
13  
14  
15

# Kabelverschraubungen Progress® aqua rostfreier Stahl A2 für Trinkwasser

## Cable glands Progress® aqua stainless steel A2 for drinking water

### Langes Anschlussgewinde metrisch | Long entry thread metric

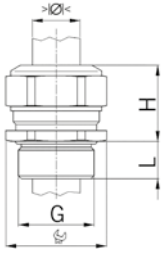

Material: Rostfreier CrNi-Stahl A2 (DIN EN 1.4305 / AISI 303)  
 Kennzeichnung: Progress aqua  
 Dichtung: EPDM  
 O-Ring: EPDM  
 Schutzart: IP 68 (bis 5 bar)  
 Zertifikat: SVGW (1603-H6481)  
 Materialprüfung: KTW W270  
 Einsatztemperatur: -40 °C / +80 °C

Material: CrNi stainless steel A2 (DIN EN 1.4305 / AISI 303)  
 Identification: Progress aqua  
 Seal: EPDM  
 O-ring: EPDM  
 Protection class: IP 68 (up to 5 bar)  
 Certificate: SVGW (1603-H6481)  
 Material testing: KTW W270  
 Operation temperature: -40 °C / +80 °C



Progress aqua



Einteiliger Dichteinsatz  
 Nicht durchgehend isolierend

One-piece sealing insert  
 not overall length insulated

G	>Ø< min mm	>Ø< max mm	mm	H mm	L mm	Art.-No.	
M12x1.5	3.5	5.0	17	17	10	W1100.12.95.050	50
M12x1.5	5.0	6.5	17	17	10	W1100.12.95.065	50
M12x1.5	6.5	8.0	17	17	10	W1100.12.95.080	50
M16x1.5	8.0	10.5	19	20	10	W1100.17.95.105	50
M20x1.5	11.0	15.0	24	21	10	W1100.20.95.150	50
M25x1.5	16.0	20.5	30	25	11	W1100.25.95.205	25
M32x1.5	21.0	25.5	36	28	13	W1100.32.95.255	25
M40x1.5	28.5	33.0	46	31	13	W1100.40.95.330	10

Weitere Ausführungen und Anschlussgewinde  
 auf Anfrage.

Further versions and entry threads  
 are available upon request.



<p>Kabelverschraubungen Progress® multiLAYER Messing                  Cable glands Progress® multiLAYER nickel-plated brass</p>		<p><b>72 - 73</b></p>	<p>1</p>
<p>Kabelverschraubungen Progress® ultraFLAT                  Cable glands Progress® ultraFLAT nickel-plated brass</p>		<p><b>74 - 75</b></p>	<p>2</p>
<p>Kabelverschraubungen Progress® Messing Winkel 90°                  Cable glands Progress® nickel-plated brass elbow 90°</p>		<p><b>76 - 78</b></p>	<p>4</p>
<p>Winkel 90° und 45° Messing mit Innen- und Aussengewinde                  Elbow 90° nickel-plated brass with internal and external thread</p>		<p><b>79 - 80</b></p>	<p>5</p>
<p>Flanschwinkel 90° Zinkdruckguss                  Flanged elbow 90° zinc diecasting</p>		<p><b>81</b></p>	<p>6</p>
<p>Universal Kabeleinführungen für Flach- und Rundkabel                  Universal cable entry for flat and round cables</p>		<p><b>82</b></p>	<p>7</p>
<p>Stopfbuchsen Messing nach DIN 46320-C4-MS                  Cable glands nickel-plated brass according to DIN 46320-C4-MS</p>		<p><b>83 - 84</b></p>	<p>9</p>
<p>Stopfbuchsen Messing mit Klemmbacken                  Cable glands nickel-plated brass with clamps</p>		<p><b>85</b></p>	<p>10</p>
<p>Stopfbuchsen Messing mit Trompete und Klemmbacken                  Cable glands nickel-plated brass with trumpet and clamps</p>		<p><b>86</b></p>	<p>11</p>
<p>Stopfbuchsen Messing mit Schutztülle und Klemmbacken                  Cable glands nickel-plated brass with antikink nozzle and clamps</p>		<p><b>87</b></p>	<p>12</p>

# Spezielle Kabelverschraubungen und Durchführungen

## Special cable glands and cable entries



Die **Progress® ultraFLAT** ist eine Kabelverschraubung für vier Anwendungsgebiete – den Reinraum, die Lebensmittelindustrie, den Antivandalismus und das Design. Die ultraflache Konstruktion der Kabelverschraubung Progress® ultraFLAT verhindert eine Manipulation von aussen. Sie bietet keine Angriffsfläche für eine Beeinträchtigung von Hand oder auch mit Werkzeugen. Ausserdem überzeugt die Kabelverschraubung durch ihre schlichte und überaus ansprechende Formgebung für den Einsatz in Design-Applikationen.

Die Kabelverschraubung Progress® ultraFLAT bietet wenig Oberfläche, an der sich Verschmutzungen ablagern können. Die gute Reinigbarkeit spricht ebenfalls für den Einsatz in Reinräumen oder der Lebensmittelindustrie. Ausführungen in Edelstahl und Dicht-einsätze für Hochtemperatur-Anwendungen oder mit FDA Konformität sprechen für diese Wahl.

Sind bei der Kabelinstallation enge Raumverhältnisse gegeben, kann der Anwender auf die Vorteile von **Winkeln und Flanschwinkeln** bauen. Hier werden Leitungen um die Ecke geführt und je nach der verwendeten Kabelverschraubung zu 100% vor der Knickstelle zugentlastet. Zur Auswahl stehen neben 90°-Winkeln auch 45°-Winkel für eine leichte Biegung des Kabels.

**Progress® ultraFLAT** is a cable gland for four application areas: Clean rooms, the food industry, anti-vandalism applications and where a stylish appearance is desired. The ultra-flat design of the **Progress® ultraFLAT** cable gland prevents tampering from the outside. It doesn't provide a surface for gripping by hand or with a tool. And thanks to its simple and very attractive design, the cable gland is also ideal for use where appearance matters.

The Progress® ultraFLAT cable gland has little surface area for dirt to collect. The good cleanability also makes it suitable use in clean rooms or the food industry. Stainless steel versions of this cable gland offer further benefits, as does the use of sealing inserts for high-temperature applications or complying with FDA requirements.

If space is at a premium the user can take advantage of the benefits of **elbow fittings – flanged and unflanged** – for cable installations. The cables are run around the bend and, depending upon the type of cable gland used, completely relieved of any strain before the kinking point. As well as 90° elbows, 45° elbows are also available for smaller cable bends.



Die Herstellung von Kabelbäumen wird vermehrt ausgelagert und externe Kabelkonfektionäre bewerkstelligen die Verkabelung von Antriebssystemen und Umformer. Da oftmals unterschiedliche Kabel verwendet werden, ist eine grössere Flexibilität im täglichen Handwerk gefragt. Mit der neuen **Progress® multiLAYER** muss pro Anschlussgewinde nur noch eine Kabelverschraubung bewirtschaftet werden.

Der neue **multiLAYER Dichteinsatz** bietet einen enorm grossen Klemmbereich und verfügt über einen integrierten Staubschutz für die Kabelverschraubung. Die geschlitzte Ausführung erlaubt eine schnelle Montage bei vorkonfektionierten Kabeln. Der Dichteinsatz nutzt die Progress® Kompressionstechnik und klemmt das Kabel schonend und ohne Einschnürung. Der neue Dichteinsatz kann problemlos mit anderen Komponenten des herausragenden Progress® Baukastens kombiniert werden.

The production of cable harnesses is increasingly outsourced, with external cable assemblers carrying out the cabling of drive systems and converters. Since cables of different types are often used, a high degree of flexibility is required in day-to-day work. With **Progress® multiLAYER**, only one type of cable gland is required per entry thread.

The new **multiLAYER sealing insert** offers great flexibility with respect to cable diameter, and features integrated dust protection for the cable gland. The splittable version allows quick installation on pre-assembled cables. Thanks to the Progress® compression technology, it clamps cables gently and without causing necking. Furthermore, this new sealing insert can be easily combined with other components of the outstanding modular Progress® product range.



# Kabelverschraubungen Progress® multiLAYER Messing

## Cable glands Progress® multiLAYER nickel-plated brass

### Kurzes Anschlussgewinde metrisch | Short entry thread metric

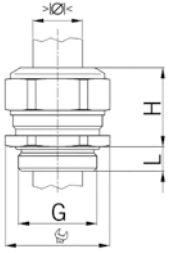

Material: Messing vernickelt  
 Dichtung: Spezial AGRO TPE hellgrau  
 O-Ring: NBR  
 Zugentlastung: Ausführung A nach EN 62444  
 Schutzart: IP 68 (bis 10 bar) / IP 69  
 Einsatztemperatur: -50 °C / +105 °C

Material: Nickel-plated brass  
 Seal: Special AGRO TPE light grey  
 O-ring: NBR  
 Strain relief: Version A acc. to EN 62444  
 Protection class: IP 68 (up to 10 bar) / IP 69  
 Operation temperature: -50 °C / +105 °C



Mehrteiliger Dichteinsatz  
 Nicht durchgehend isolierend

Multi-piece sealing insert  
 not overall length insulated

G	>Ø < min mm	>Ø < max mm	Ø mm	H mm	L mm	Art.-No.	
M20x1.5	4.0	15.0	24	23	6	F1000.4.20	50
M25x1.5	6.0	20.5	30	28	7	F1000.4.25	25
M32x1.5	10.0	25.5	36	28	8	F1000.4.32	25



### Langes Anschlussgewinde metrisch | Long entry thread metric



Mehrteiliger Dichteinsatz  
 Nicht durchgehend isolierend

Multi-piece sealing insert  
 not overall length insulated

G	>Ø < min mm	>Ø < max mm	Ø mm	H mm	L mm	Art.-No.	
M20x1.5	4.0	15.0	24	23	10	F1100.4.20	50
M25x1.5	6.0	20.5	30	28	11	F1100.4.25	25
M32x1.5	10.0	25.5	36	28	13	F1100.4.32	25



### Anschlussgewinde metrisch | Entry thread metric

Material:	Polyamid glasfaserverstärkt	Material:	Polyamide glass fiber reinforced
Eigenschaften:	halogenfrei	Properties:	halogen-free
Dichtung:	TPE	Seal:	TPE
Zugentlastung:	Ausführung A nach EN 62444	Strain relief:	Version A acc. to EN 62444
Schutzart:	IP 68	Protection class:	IP 68
Einsatztemperatur:	-20 °C / +100 °C	Operation temperature:	-20 °C / +100 °C

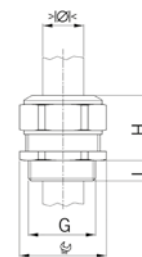

Hellgrau RAL 7035 Mehrteiliger Dichteinsatz		Light grey RAL 7035 Multi-piece sealing insert				
G	$\begin{matrix} > \ominus < \\ \text{min mm} \end{matrix}$	$\begin{matrix} > \ominus < \\ \text{max mm} \end{matrix}$	$\begin{matrix} \text{H} \\ \text{mm} \end{matrix}$	$\begin{matrix} \text{L} \\ \text{mm} \end{matrix}$	Art.-No.	
M20x1.5	4.0	15.0	27	28	1571.4.20	50
M25x1.5	6.0	20.5	34	33	1571.4.25	25
M32x1.5	10.0	25.5	41	35	1571.4.32	25



Schwarz RAL 9005 Mehrteiliger Dichteinsatz		Black RAL 9005 Multi-piece sealing insert				
G	$\begin{matrix} > \ominus < \\ \text{min mm} \end{matrix}$	$\begin{matrix} > \ominus < \\ \text{max mm} \end{matrix}$	$\begin{matrix} \text{H} \\ \text{mm} \end{matrix}$	$\begin{matrix} \text{L} \\ \text{mm} \end{matrix}$	Art.-No.	
M20x1.5	4.0	15.0	27	28	1540.4.20	50
M25x1.5	6.0	20.5	34	33	1540.4.25	25
M32x1.5	10.0	25.5	41	35	1540.4.32	25



Weiss RAL 9010 Mehrteiliger Dichteinsatz		White RAL 9010 Multi-piece sealing insert				
G	$\begin{matrix} > \ominus < \\ \text{min mm} \end{matrix}$	$\begin{matrix} > \ominus < \\ \text{max mm} \end{matrix}$	$\begin{matrix} \text{H} \\ \text{mm} \end{matrix}$	$\begin{matrix} \text{L} \\ \text{mm} \end{matrix}$	Art.-No.	
M20x1.5	4.0	15.0	27	28	1520.4.20	50
M25x1.5	6.0	20.5	34	33	1520.4.25	25



# Kabelverschraubungen Progress® ultraFLAT Messing

## Cable glands Progress® ultraFLAT nickel-plated brass

### Anschlussgewinde metrisch | Entry thread metric

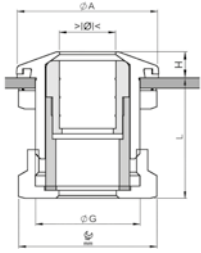

Frontring:	Messing halbglanz vernickelt	Front part:	semi-bright nickel-plated brass
Druckmutter:	Messing vernickelt	Push-down nut:	Nickel-plated brass
Dichtung:	TPE	Seal:	TPE
Dichtscheibe:	FPM	Sealing washer:	FPM
Zugentlastung:	Ausführung A nach EN 62444	Strain relief:	Version A acc. to EN 62444
Wandstärke:	max. 5 mm	Wall thickness:	max. 5 mm
Schutzart:	IP 68 (bis 10 bar) / IP 69	Protection class:	IP 68 (up to 10 bar) / IP 69
Einsatztemperatur:	-40 °C / +100 °C	Operation temperature:	-40 °C / +100 °C



Einteiliger Dichteinsatz  
Nicht durchgehend isolierend

One-piece sealing insert  
not overall length insulated

G	> Ø < min mm	> Ø < max mm	mm	ØA mm	H mm	L mm	Art.-No.	
<b>M16x1.5</b>	5.0	6.5	19	22	4.0	21	<b>1040.17.40.065</b>	25
<b>M16x1.5</b>	6.5	8.0	19	22	4.0	21	<b>1040.17.40.080</b>	25
<b>M20x1.5</b>	6.0	8.0	24	27	4.5	23	<b>1040.20.40.080</b>	25
<b>M20x1.5</b>	8.0	10.5	24	27	4.5	23	<b>1040.20.40.105</b>	25
<b>M25x1.5</b>	8.0	11.0	30	32	5.5	25	<b>1040.25.40.110</b>	20
<b>M25x1.5</b>	11.0	15.0	30	32	5.5	25	<b>1040.25.40.150</b>	20
<b>M32x1.5</b>	12.5	16.0	36	39	6.0	28	<b>1040.32.40.160</b>	10
<b>M32x1.5</b>	16.0	20.5	36	39	6.0	28	<b>1040.32.40.205</b>	10

Auf Anfrage lieferbar:

Available on request:

Rostfreier und säurebeständiger Stahl A4

Stainless steel and acid resistant A4

# Kabelverschraubungen Progress® ultraFLAT rostfreier Stahl A2

## Cable glands Progress® ultraFLAT stainless steel A2

### Anschlussgewinde metrisch | Entry thread metric

Frontring:	Rostfreier CrNi-Stahl A2 (DIN EN 1.4305 / AISI 303)	Front part:	CrNi stainless steel A2 (DIN EN 1.4305 / AISI 303)
Druckmutter:	Messing vernickelt	Push-down nut:	Nickel-plated brass
Dichtung:	FKM	Seal:	FKM
Dichtscheibe:	FKM	Sealing washer:	FKM
Zugentlastung:	Ausführung A nach EN 62444	Strain relief:	Version A acc. to EN 62444
Wandstärke:	max. 5 mm	Wall thickness:	max. 5 mm
Schutzart:	IP 68 (bis 10 bar) / IP 69	Protection class:	IP 68 (up to 10 bar) / IP 69
Einsatztemperatur:	-40 °C / +200 °C	Operation temperature:	-40 °C / +200 °C

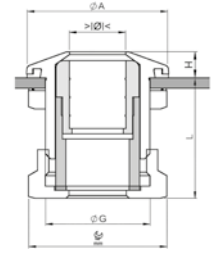

Einteiliger Dichteinsatz  
Nicht durchgehend isolierend

One-piece sealing insert  
not overall length insulated

G	$>10<$ min mm	$>10<$ max mm	$\varnothing A$ mm	H mm	L mm	i info	Art.-No.	
M16x1.5	5.0	6.5	19	22	4.0	21	1040.17.96.30.065	25
M16x1.5	6.5	8.0	19	22	4.0	21	1040.17.96.30.080	25
M20x1.5	6.0	8.0	24	27	4.5	23	1040.20.96.30.080	25
M20x1.5	8.0	10.5	24	27	4.5	23	1040.20.96.30.105	25
M25x1.5	8.0	11.0	30	32	5.5	25	1040.25.96.30.110	20
M25x1.5	11.0	15.0	30	32	5.5	25	1040.25.96.30.150	20
M32x1.5	12.5	16.0	36	39	6.0	28	1040.32.96.30.160	10
M32x1.5	16.0	20.5	36	39	6.0	28	1040.32.96.30.205	10

1 = Lieferbar auf Anfrage  
FDA konforme Dichtungen

1 = Available on request  
FDA-cleared sealings



### Anschlussgewinde metrisch | Entry thread metric

Frontring:	Rostfreier CrNi-Stahl A2 (DIN EN 1.4305 / AISI 303)	Front part:	CrNi stainless steel A2 (DIN EN 1.4305 / AISI 303)
Druckmutter:	Messing vernickelt	Push-down nut:	Nickel-plated brass
Dichtung:	FPM	Seal:	FPM
Dichtscheibe:	FPM	Sealing washer:	FPM
Zugentlastung:	Ausführung A nach EN 62444	Strain relief:	Version A acc. to EN 62444
Wandstärke:	max. 5 mm	Wall thickness:	max. 5 mm
Schutzart:	IP 68 (bis 10 bar) / IP 69	Protection class:	IP 68 (up to 10 bar) / IP 69
Einsatztemperatur:	-40 °C / +200 °C	Operation temperature:	-40 °C / +200 °C

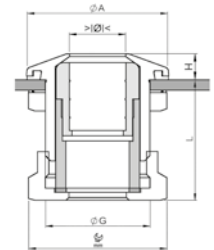

Einteiliger Dichteinsatz  
Nicht durchgehend isolierend

One-piece sealing insert  
not overall length insulated

G	$>10<$ min mm	$>10<$ max mm	$\varnothing A$ mm	H mm	L mm	i info	Art.-No.	
M16x1.5	5.0	6.5	19	22	4.0	21	1040.17.96.70.065	25
M16x1.5	6.5	8.0	19	22	4.0	21	1040.17.96.70.080	25
M20x1.5	6.0	8.0	24	27	4.5	23	1040.20.96.70.080	25
M20x1.5	8.0	10.5	24	27	4.5	23	1040.20.96.70.105	25
M25x1.5	8.0	11.0	30	32	5.5	25	1040.25.96.70.110	20
M25x1.5	11.0	15.0	30	32	5.5	25	1040.25.96.70.150	20
M32x1.5	12.5	16.0	36	39	6.0	28	1040.32.96.70.160	10
M32x1.5	16.0	20.5	36	39	6.0	28	1040.32.96.70.205	10

1 = Lieferbar auf Anfrage

1 = Available on request



# Kabelverschraubungen Progress® Messing Winkel 90°

## Cable glands Progress® nickel-plated brass elbow 90°

### Kurzes Anschlussgewinde metrisch | Short entry thread metric

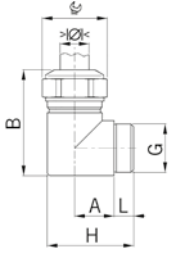

Material: Messing vernickelt  
 Dichtung: TPE  
 Zugentlastung: Ausführung A nach EN 62444  
 Schutzart: IP 68  
 Gewinde: IP 68, wenn Anschlussgewinde abgedichtet  
 Einsatztemperatur: -40 °C / +100 °C

Material: Nickel-plated brass  
 Seal: TPE  
 Strain relief: Version A acc. to EN 62444  
 Protection class: IP 68  
 Entry thread: IP 68, if the entry thread is sealed  
 Operation temperature: -40 °C / +100 °C



Progress MS W90



Zweiteiliger Dichteinsatz  
 Nicht durchgehend isolierend

Two-piece sealing insert  
 not overall length insulated

G	>Ø< min mm	>Ø< max mm	>Ø< min mm	>Ø< max mm	mm	H mm	L mm	A mm	B mm	i info	Art.-No.	
M12x1.5	-	-	5.0	6.5	15	27	8	11	32	1	5200.12	50
M16x1.5	6.0	8.0	8.0	10.5	18	30	8	13	36	-	5200.17	50
M20x1.5	8.0	11.0	11.0	15.0	24	35	8	16	44	-	5200.20	50
M25x1.5	12.5	16.0	16.0	20.5	30	44	10	20	52	-	5200.25	25
M32x1.5	17.0	21.0	21.0	25.5	36	50	10	23	60	-	5200.32	25
M40x1.5	24.0	28.5	28.5	33.0	46	60	10	28	72	-	5200.40	10

1 = Einteiliger Dichteinsatz

1 = One-piece sealing insert

Erhältlich mit Dichteinsatz gemäss EN 45545 / NFPA 130. Bei Anfragen oder Bestellung bitte ein F vor die Artikelnummer setzen.

Available with sealing inserts conformity with EN 45545 / NFPA 130. When placing an inquiry, prefix the article number by the capital F.

### Langes Anschlussgewinde metrisch | Long entry thread metric



Progress MS W90



Zweiteiliger Dichteinsatz  
 Nicht durchgehend isolierend

Two-piece sealing insert  
 not overall length insulated

G	>Ø< min mm	>Ø< max mm	>Ø< min mm	>Ø< max mm	mm	H mm	L mm	A mm	B mm	i info	Art.-No.	
M12x1.5	-	-	5.0	6.5	15	30	12	11	32	1	5210.12	50
M16x1.5	6.0	8.0	8.0	10.5	18	34	12	13	36	-	5210.17	50
M20x1.5	8.0	11.0	11.0	15.0	24	39	12	16	44	-	5210.20	50
M25x1.5	12.5	16.0	16.0	20.5	30	48	14	20	52	-	5210.25	25
M32x1.5	17.0	21.0	21.0	25.5	36	56	16	23	60	-	5210.32	25
M40x1.5	24.0	28.5	28.5	33.0	46	66	16	28	72	-	5210.40	10

1 = Einteiliger Dichteinsatz

1 = One-piece sealing insert

Erhältlich mit Dichteinsatz gemäss EN 45545 / NFPA 130. Bei Anfragen oder Bestellung bitte ein F vor die Artikelnummer setzen.

Available with sealing inserts conformity with EN 45545 / NFPA 130. When placing an inquiry, prefix the article number by the capital F.

# Kabelverschraubungen Progress® Messing Winkel 90° Cable glands Progress® nickel-plated brass elbow 90°

## Kurzes Anschlussgewinde Pg | Short entry thread Pg

Material: Messing vernickelt  
Dichtung: TPE  
Schutzart: IP 68  
Gewinde: IP 68, wenn Anschluss-  
gewinde abgedichtet  
Einsatztemperatur: -40 °C / +100 °C

Material: Nickel-plated brass  
Seal: TPE  
Protection class: IP 68  
Entry thread: IP 68, if the entry thread  
is sealed  
Operation temperature: -40 °C / +100 °C

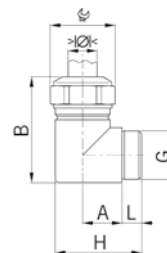

Zweiteiliger Dichteinsatz  
Nicht durchgehend isolierend

Two-piece sealing insert  
not overall length insulated

G	> Ø <	> Ø <	> Ø <	> Ø <	mm	H	L	A	B	i	Art.-No.	
	min mm	max mm	min mm	max mm	mm	mm	mm	mm	mm	info		
<b>Pg 7</b>	-	-	5.0	6.5	15	27	8	11	32	1	<b>5200.07</b>	50
<b>Pg 9</b>	6.0	8.0	8.0	10.5	18	30	8	13	36	-	<b>5200.09</b>	50
<b>Pg 11</b>	5.5	8.5	8.5	12.0	21	35	8	14	40	-	<b>5200.11</b>	50
<b>Pg 13</b>	8.0	11.0	11.0	15.0	24	41	10	16	44	-	<b>5200.13</b>	50
<b>Pg 16</b>	8.0	11.0	11.0	15.0	24	41	10	16	44	-	<b>5200.16</b>	50
<b>Pg 21</b>	12.5	16.0	16.0	20.5	30	44	10	20	52	-	<b>5200.21</b>	25
<b>Pg 29</b>	19.0	23.0	23.0	27.5	38	56	10	24	65	-	<b>5200.29</b>	10

1 = Einteiliger Dichteinsatz

1 = One-piece sealing insert

Erhältlich mit Dichteinsatz gemäss EN 45545 / NFPA 130.  
Bei Anfragen oder Bestellung bitte ein F vor die Artikel-  
nummer setzen.

Available with sealing inserts conformity with EN 45545 /  
NFPA 130. When placing an inquiry, prefix the article  
number by the capital F.



## Langes Anschlussgewinde Pg | Long entry thread Pg

Zweiteiliger Dichteinsatz  
Nicht durchgehend isolierend

Two-piece sealing insert  
not overall length insulated

G	> Ø <	> Ø <	> Ø <	> Ø <	mm	H	L	A	B	i	Art.-No.	
	min mm	max mm	min mm	max mm	mm	mm	mm	mm	mm	info		
<b>Pg 7</b>	-	-	5.0	6.5	15	30	11	11	32	1	<b>5210.07</b>	50
<b>Pg 9</b>	6.0	8.0	8.0	10.5	18	34	11	13	36	-	<b>5210.09</b>	50
<b>Pg 11</b>	5.5	8.5	8.5	12.0	21	38	11	14	40	-	<b>5210.11</b>	50
<b>Pg 13</b>	8.0	11.0	11.0	15.0	24	44	13	16	44	-	<b>5210.13</b>	50
<b>Pg 16</b>	8.0	11.0	11.0	15.0	24	44	13	16	44	-	<b>5210.16</b>	50
<b>Pg 21</b>	12.5	16.0	16.0	20.5	30	48	14	20	52	-	<b>5210.21</b>	25
<b>Pg 29</b>	19.0	23.0	23.0	27.5	38	60	14	24	65	-	<b>5210.29</b>	10

1 = Einteiliger Dichteinsatz

1 = One-piece sealing insert

Erhältlich mit Dichteinsatz gemäss EN 45545 / NFPA 130.  
Bei Anfragen oder Bestellung bitte ein F vor die Artikel-  
nummer setzen.

Available with sealing inserts conformity with EN 45545 /  
NFPA 130. When placing an inquiry, prefix the article  
number by the capital F.



# Kabelverschraubungen Progress® Messing Winkel 90°

## Cable glands Progress® nickel-plated brass elbow 90°

### Langes Anschlussgewinde metrisch mit Gegenmutter | Long entry thread metric with lock nut

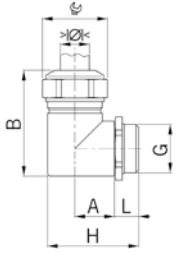

Material: Messing vernickelt  
 Dichtung: TPE  
 O-Ring: NBR  
 Zugentlastung: Ausführung A nach EN 62444  
 Schutzart: IP 68  
 Einsatztemperatur: -40 °C / +100 °C

Material: Nickel-plated brass  
 Seal: TPE  
 O-ring: NBR  
 Strain relief: Version A acc. to EN 62444  
 Protection class: IP 68  
 Operation temperature: -40 °C / +100 °C



Progress MS W90



Zweiteiliger Dichteinsatz  
 Nicht durchgehend isolierend

Two-piece sealing insert  
 not overall length insulated

G	>Ø< min mm	>Ø< max mm	>Ø< min mm	>Ø< max mm	mm	H mm	L mm	A mm	B mm	i info	Art.-No.	
M12x1.5	-	-	5.0	6.5	15	30	12	11	32	1	5215.12	50
M16x1.5	6.0	8.0	8.0	10.5	18	34	12	13	36	-	5215.17	50
M20x1.5	8.0	11.0	11.0	15.0	24	39	12	16	44	-	5215.20	50
M25x1.5	12.5	16.0	16.0	20.5	30	48	14	20	52	-	5215.25	25
M32x1.5	17.0	21.0	21.0	25.5	36	56	16	23	60	-	5215.32	25
M40x1.5	24.0	28.5	28.5	33.0	46	66	16	28	72	-	5215.40	10

1 = Einteiliger Dichteinsatz

1 = One-piece sealing insert

Erhältlich mit Dichteinsatz gemäss EN 45545 / NFPA 130.  
 Bei Anfragen oder Bestellung bitte ein F vor die Artikelnummer setzen.

Available with sealing inserts conformity with EN 45545 / NFPA 130. When placing an inquiry, prefix the article number by the capital F.

### Langes Anschlussgewinde Pg mit Gegenmutter | Long entry thread Pg with lock nut

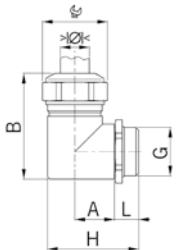

Material: Messing vernickelt  
 Dichtung: TPE  
 O-Ring: NBR  
 Schutzart: IP 68  
 Einsatztemperatur: -40 °C / +100 °C

Material: Nickel-plated brass  
 Seal: TPE  
 O-ring: NBR  
 Protection class: IP 68  
 Operation temperature: -40 °C / +100 °C



Zweiteiliger Dichteinsatz  
 Nicht durchgehend isolierend

Two-piece sealing insert  
 not overall length insulated

G	>Ø< min mm	>Ø< max mm	>Ø< min mm	>Ø< max mm	mm	H mm	L mm	A mm	B mm	i info	Art.-No.	
Pg 7	-	-	5.0	6.5	15	30	11	11	32	1	5215.07	50
Pg 9	6.0	8.0	8.0	10.5	18	34	11	13	36	-	5215.09	50
Pg 11	5.5	8.5	8.5	12.0	21	38	11	14	40	-	5215.11	50
Pg 13	8.0	11.0	11.0	15.0	24	44	13	16	44	-	5215.13	50
Pg 16	8.0	11.0	11.0	15.0	24	44	13	16	44	-	5215.16	50
Pg 21	12.5	16.0	16.0	20.5	30	48	14	20	52	-	5215.21	25
Pg 29	19.0	23.0	23.0	27.5	38	60	14	24	65	-	5215.29	10

1 = Einteiliger Dichteinsatz

1 = One-piece sealing insert

Erhältlich mit Dichteinsatz gemäss EN 45545 / NFPA 130.  
 Bei Anfragen oder Bestellung bitte ein F vor die Artikelnummer setzen.

Available with sealing inserts conformity with EN 45545 / NFPA 130. When placing an inquiry, prefix the article number by the capital F.

# Winkel 90° Messing mit Innen- und Aussengewinde Elbow 90° nickel-plated brass with internal and external thread

## Anschlussgewinde metrisch | Entry thread metric

Material: Messing vernickelt  
O-Ring: NBR  
Schutzart: IP 54  
Weitere Schutzart: IP 68, wenn Anschluss-  
gewinde abgedichtet  
Einsatztemperatur: -40 °C / +100 °C

Material: Nickel-plated brass  
O-ring: NBR  
Protection class: IP 54  
Further protection: IP 68, if the entry thread  
is sealed  
Operation temperature: -40 °C / +100 °C

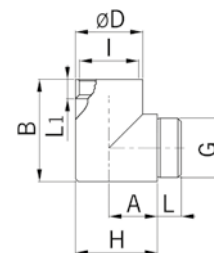

Mit O-Ring

with O-ring

G	I	D	L	L1	A	B	H	Art.-No.	
		mm	mm	mm	mm	mm	mm		
<b>M12x1.5</b>	M12x1.5	15	5.0	7	13	25	20	<b>5612</b>	50
<b>M16x1.5</b>	M16x1.5	19	6.5	7	16	29	26	<b>5617</b>	50
<b>M20x1.5</b>	M20x1.5	24	6.0	10	19	37	31	<b>5620</b>	50
<b>M25x1.5</b>	M25x1.5	29	7.5	10	23	42	37	<b>5625</b>	25
<b>M32x1.5</b>	M32x1.5	36	8.5	11	26	50	44	<b>5632</b>	25
<b>M40x1.5</b>	M40x1.5	46	9.5	17	34	67	57	<b>5640</b>	10
<b>M50x1.5</b>	M50x1.5	56	9.0	17	41	77	69	<b>5650</b>	10



## Anschlussgewinde Pg | Entry thread Pg

Mit O-Ring

with O-ring

G	I	D	L	L1	A	B	H	Art.-No.	
		mm	mm	mm	mm	mm	mm		
<b>Pg 7</b>	Pg 7	16	7.0	7	13	23	21	<b>5607</b>	50
<b>Pg 9</b>	Pg 9	18	7.0	7	15	26	24	<b>5609</b>	50
<b>Pg 11</b>	Pg 11	22	8.0	8	18	31	29	<b>5611</b>	50
<b>Pg 13</b>	Pg 13	24	10.0	10	19	34	31	<b>5613</b>	50
<b>Pg 16</b>	Pg 16	26	10.0	10	20	36	33	<b>5616</b>	50
<b>Pg 21</b>	Pg 21	34	11.0	11	24	46	41	<b>5621</b>	25
<b>Pg 29</b>	Pg 29	41	11.0	11	28	52	49	<b>5629</b>	20
<b>Pg 36</b>	Pg 36	52	12.0	17	38	82	64	<b>5636</b>	10



# Winkel 45° Messing mit Innen- und Aussengewinde

## Elbows 45° nickel-plated brass with internal and external thread

### Anschlussgewinde metrisch | Entry thread metric

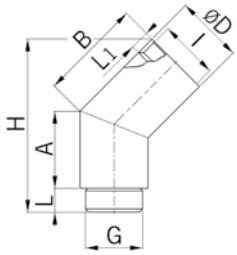

Material: Messing vernickelt  
 O-Ring: NBR  
 Schutzart: IP 54  
 Weitere Schutzart: IP 68, wenn Anschluss-  
 gewinde abgedichtet  
 Einsatztemperatur: -40 °C / +100 °C

Material: Nickel-plated brass  
 O-ring: NBR  
 Protection class: IP 54  
 Further protection: IP 68, if the entry thread  
 is sealed  
 Operation temperature: -40 °C / +100 °C



Mit O-Ring

with O-ring

<b>G</b>	<b>I</b>	<b>D</b> mm	<b>L</b> mm	<b>L1</b> mm	<b>A</b> mm	<b>B</b> mm	<b>H</b> mm
<b>M16x1.5</b>	M16x1.5	19	6.5	7	13	18	26
<b>M20x1.5</b>	M20x1.5	24	6.0	10	17	23	33
<b>M25x1.5</b>	M25x1.5	29	7.5	10	18	25	36
<b>M32x1.5</b>	M32x1.5	36	8.5	11	21	28	41

Art.-No.



<b>5717</b>	50
<b>5720</b>	50
<b>5725</b>	25
<b>5732</b>	25

# Flanschwinkel 90° Zinkdruckguss

## Flanged elbow 90° zinc diecasting

### Anschlussgewinde metrisch | Entry thread metric

Material:	Zinkdruckguss vernickelt	Material:	Zinc diecasting nickel-plated
Dichtung:	NBR	Seal:	NBR
Schutzart:	IP 65	Protection class:	IP 65
Eigenschaften:	Für spritzwasserdichte Montage an der Gehäusewandung mit Anschlussgewinde für Kabel- oder Schlauchverschraubung	Properties:	For splash water-proof mounting on casing walls with entry thread for cable glands or conduit glands
Einsatztemperatur:	-40 °C / +100 °C	Operation temperature:	-40 °C / +100 °C

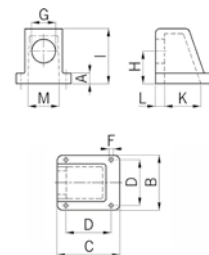

mit 1 Anschlussgewinde

with 1 entry thread

G	B/C mm	D mm	F mm	A mm	H mm	I mm	K mm	L mm	M mm	Art.-No.	
<b>M16x1.5</b>	45 x 48	37	4.3	8	15.5	30	28	10.5	24	<b>5517</b>	10
<b>M20x1.5</b>	53 x 56	44	5.5	8	18.0	35	34	10.5	24	<b>5520</b>	10
<b>M25x1.5</b>	63 x 65	54	5.5	8	22.5	42	43	11.0	35	<b>5525</b>	5
<b>M32x1.5</b>	71 x 75	60	5.5	10	27.0	52	53	11.0	38	<b>5532</b>	5
<b>M40x1.5</b>	71 x 75	60	5.5	10	27.0	52	53	11.0	38	<b>5540</b>	5
<b>M50x1.5</b>	89 x 93	72	6.5	11	33.5	69	65	18.0	50	<b>5550</b>	1
<b>M63x1.5</b>	96 x 114	84	4.3	10	37.0	74	86	14.0	67	<b>5563</b>	2



### Anschlussgewinde Pg | Entry thread Pg

Material:	Zinkdruckguss	Material:	Zinc diecasting
Farbe:	Hammerschlaglackiert grau	Colour:	Hammergrey enamel
Dichtung:	NBR	Seal:	NBR
Schutzart:	IP 65	Protection class:	IP 65
Eigenschaften:	Für spritzwasserdichte Montage an der Gehäusewandung mit Anschlussgewinde für Kabel- oder Schlauchverschraubung	Properties:	For splash water-proof mounting on casing walls with entry thread for cable glands or conduit glands
Einsatztemperatur:	-40 °C / +100 °C	Operation temperature:	-40 °C / +100 °C

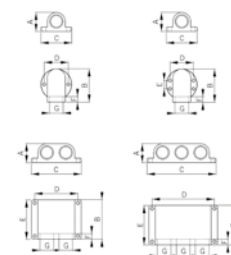

Mit 1 bis 3 Anschlussgewinden

With 1 to 3 entry threads

G		A mm	B mm	C mm	D mm	E mm	F mm	Art.-No.		
<b>Pg 16</b>	1	31	42	42	36.0	-	11	2x4.5	<b>5516.10</b>	10
<b>Pg 16</b>	2	34	70	91	79.0	58	10	4x5.5	<b>5516.12</b>	10
<b>Pg 16</b>	3	34	70	124	111.0	56	10	4x5.5	<b>5516.13</b>	10
<b>Pg 21</b>	1	40	60	60	52.5	-	12	2x5.2	<b>5521.10</b>	10
<b>Pg 29</b>	1	51.5	76	66	54.0	36	12	4x5.5	<b>5529.10</b>	10
<b>Pg 36</b>	1	62	90	85	73.0	30	12	4x5.5	<b>5536.10</b>	10



# Universal Kabeleinführung für Flach- und Rundkabel

## Universal cable entry for flat and round cables

### Für Flach- und Rundkabel | For flat and round cables

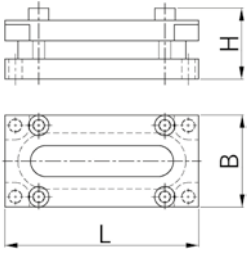

Material: Alu (AlMgSi0.5)  
 Eigenschaften: Universal für ein oder mehrere Kabel, auch mit verschiedenen Abmessungen und Durchmessern. Max. Einbau von Flachkabeln 70x12 mm.  
 Dichtung: NBR  
 Schutzart: IP 54 - IP 68  
 Einsatztemperatur: -40 °C / +100 °C

Material: Alu (AlMgSi0.5)  
 Properties: Universally applicable for one or several cable(s) with various dimensions and diameters. Max. cable dimension 70x12 mm.  
 Seal: NBR  
 Protection class: IP 54 - IP 68  
 Operation temperature: -40 °C / +100 °C



Aluminium Gehäuse zweiteilig  
 Mit Dichtscheibe  
 Universeller Dichtungseinsatz

Two-piece aluminium housing  
 With sealing washer  
 Universal sealing insert

L x B mm	 mm	H mm	i info	Art.-No.	
95x45	70.0x12.0	35	-	1370.15	5
95x45	49.0x4.5	35	-	1370.15.49.04	5
95x45	2x49.0x4.5	35	-	1370.15.49.45	5
95x45	63.0x12.0	35	-	1370.15.63.12	5
95x45	max.70.0x12.0	35	1	1370.15.30	5

1 = Vollgummi-Dichteinsätze auf die entsprechende Kabeldimension aufbohren (Rundkabel Ø +1mm)

1 = Drill solid rubber inserts to match the appropriate cable diameter (round cables ø +1 mm)

Dichteinsätze ohne Bohrung lassen sich gut bearbeiten, wenn sie vorher auf mindestens -25°C gefroren wurden.

When frozen to at least -25°C, the solid sealing inserts are easy to drill.

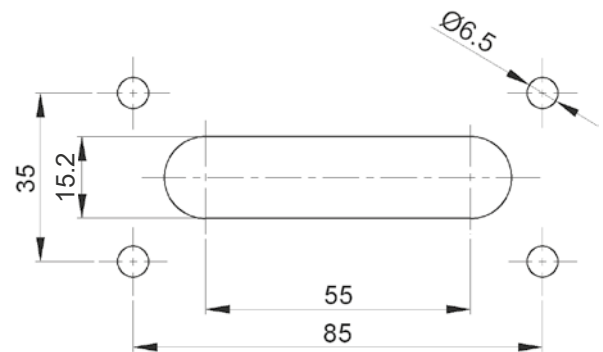
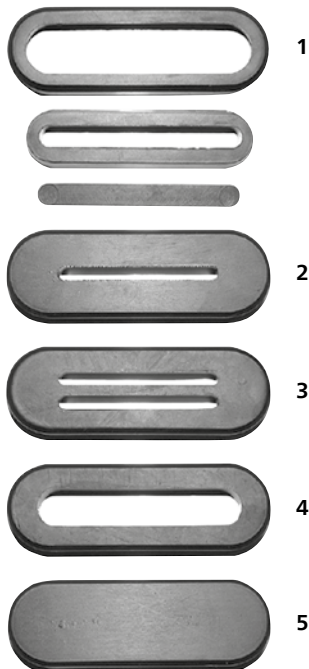

# Stopfbuchsen Messing nach DIN 46320-C4-MS

## Cable glands nickel-plated brass according to DIN 46320-C4-MS

### Kurzes Anschlussgewinde metrisch | Short entry thread metric

Material: Messing vernickelt  
 Dichtung: NBR  
 Schutzart: IP 54  
 Einsatztemperatur: -20 °C / +80 °C

Material: Nickel-plated brass  
 Seal: NBR  
 Protection class: IP 54  
 Operation temperature: -20 °C / +80 °C

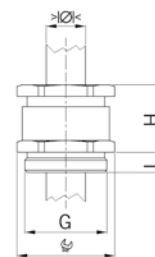

Einteiliger Einschnittring  
 Nicht durchgehend isolierend

One piece sealing ring  
 not overall length insulated

G	$\begin{matrix} >10< \\ \text{min mm} \end{matrix}$	$\begin{matrix} >10< \\ \text{max mm} \end{matrix}$	$\begin{matrix} \text{mm} \\ \text{mm} \end{matrix}$	H mm	L mm	Art.-No.	
M12x1.5	5.0	7.0	14/13	15	5	B 112	100
M16x1.5	6.0	8.0	18/15	15	5	B 117	100
M20x1.5	8.0	10.0	22/18	19	6	B 120.10	50
M20x1.5	10.0	12.0	22/20	19	6	B 120.12	50
M20x1.5	12.0	14.0	22/20	19	6	B 120.14	50
M25x1.5	15.0	17.0	30/28	23	7	B 125	50
M32x1.5	24.0	26.0	40/37	26	8	B 132	25
M40x1.5	33.0	35.0	50/47	30	8	B 140	20
M50x1.5	39.0	41.0	57/54	34	9	B 150	10
M63x1.5	45.0	47.0	66/60	35	10	B 163	10



### Langes Anschlussgewinde metrisch | Long entry thread metric

Einteiliger Einschnittring  
 Nicht durchgehend isolierend

One piece sealing ring  
 not overall length insulated

G	$\begin{matrix} >10< \\ \text{min mm} \end{matrix}$	$\begin{matrix} >10< \\ \text{max mm} \end{matrix}$	$\begin{matrix} \text{mm} \\ \text{mm} \end{matrix}$	H mm	L mm	Art.-No.	
M12x1.5	5.0	7.0	14/13	15	10	B 212	100
M16x1.5	6.0	8.0	18/15	15	10	B 217	100
M20x1.5	8.0	10.0	22/18	19	10	B 220.10	50
M20x1.5	10.0	12.0	22/20	19	10	B 220.12	50
M20x1.5	12.0	14.0	22/20	19	10	B 220.14	50
M25x1.5	15.0	17.0	30/28	23	12	B 225	50
M32x1.5	24.0	26.0	40/37	26	12	B 232	25
M40x1.5	33.0	35.0	50/47	30	14	B 240	20
M50x1.5	39.0	41.0	57/54	34	14	B 250	10
M63x1.5	45.0	47.0	66/60	35	14	B 263	10



# Stopfbuchsen Messing nach DIN 46320-C4-MS

## Cable glands nickel-plated brass according to DIN 46320-C4-MS

### Kurzes Anschlussgewinde Pg | Short entry thread Pg

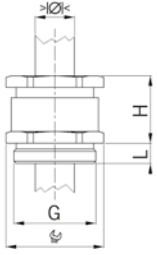

Material: Messing vernickelt  
 Dichtung: NBR  
 Schutzart: IP 54  
 Einsatztemperatur: -20 °C / +80 °C

Material: Nickel-plated brass  
 Seal: NBR  
 Protection class: IP 54  
 Operation temperature: -20 °C / +80 °C



Einteiliger Einschnittring  
 Nicht durchgehend isolierend

One piece sealing ring  
 not overall length insulated

G	> Ø <	> Ø <	mm	H	L	Art.-No.	
	min mm	max mm	mm	mm	mm		
<b>Pg 7</b>	5.0	7.0	14/13	15	5	<b>B 107</b>	50
<b>Pg 9</b>	4.0	10.0	17/15	15	5	<b>B 109</b>	50
<b>Pg 11</b>	6.5	12.0	20/18	17	6	<b>B 111</b>	50
<b>Pg 13</b>	6.5	13.5	22/20	20	6	<b>B 113</b>	50
<b>Pg 16</b>	6.5	16.0	24/22	22	6	<b>B 116</b>	50
<b>Pg 21</b>	9.0	20.0	30/28	24	7	<b>B 121</b>	50
<b>Pg 29</b>	17.0	28.0	40/37	26	8	<b>B 129</b>	25
<b>Pg 36</b>	23.0	34.0	50/47	30	9	<b>B 136</b>	10
<b>Pg 42</b>	29.0	40.0	57/54	34	10	<b>B 142</b>	10
<b>Pg 48</b>	35.0	46.0	64/60	37	10	<b>B 148.48</b>	10

### Langes Anschlussgewinde Pg | Long entry thread Pg



Einteiliger Einschnittring  
 Nicht durchgehend isolierend

One piece sealing ring  
 not overall length insulated

G	> Ø <	> Ø <	mm	H	L	Art.-No.	
	min mm	max mm	mm	mm	mm		
<b>Pg 9</b>	4.0	10.0	17/15	15	15	<b>B 209</b>	50
<b>Pg 11</b>	6.5	12.0	20/18	17	15	<b>B 211</b>	50
<b>Pg 13</b>	6.5	13.5	22/20	20	15	<b>B 213</b>	50
<b>Pg 16</b>	6.5	16.0	24/22	22	15	<b>B 216</b>	50
<b>Pg 21</b>	9.0	20.0	30/28	24	15	<b>B 221</b>	50
<b>Pg 29</b>	17.0	28.0	40/37	26	15	<b>B 229</b>	25
<b>Pg 36</b>	23.0	34.0	50/47	30	15	<b>B 236</b>	10
<b>Pg 42</b>	29.0	40.0	57/54	34	15	<b>B 242</b>	10
<b>Pg 48</b>	35.0	46.0	64/60	37	15	<b>B 248.48</b>	10

# Stopfbuchsen Messing mit Klemmbacken Cable glands nickel-plated brass with clamps

## Kurzes Anschlussgewinde metrisch | Short entry thread metric

Material: Messing vernickelt  
Dichtung: NBR  
Schutzart: IP 54  
Einsatztemperatur: -20 °C / +80 °C

Material: Nickel-plated brass  
Seal: NBR  
Protection class: IP 54  
Operation temperature: -20 °C / +80 °C

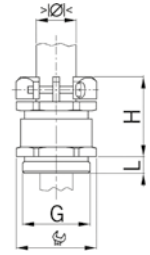

Einteiliger Einschnittring  
Nicht durchgehend isolierend

One piece sealing ring  
not overall length insulated

G	$\begin{matrix} > \varnothing < \\ \text{min mm} \end{matrix}$	$\begin{matrix} > \varnothing < \\ \text{max mm} \end{matrix}$	$\begin{matrix} \varnothing \\ \text{mm} \end{matrix}$	H mm	L mm	Art.-No.	
<b>M12x1.5</b>	5.0	7.0	14/17	22	5	<b>1803.12</b>	50
<b>M16x1.5</b>	6.0	8.0	17/20	25	6	<b>1803.17</b>	50
<b>M20x1.5</b>	8.0	10.0	24/27	26	6	<b>1803.20</b>	50
<b>M25x1.5</b>	15.0	17.0	30/35	28	6	<b>1803.25</b>	25
<b>M32x1.5</b>	24.0	26.0	40/43	29	6	<b>1803.32</b>	25
<b>M40x1.5</b>	33.0	35.0	50/55	33	7	<b>1803.40</b>	10



## Kurzes Anschlussgewinde Pg | Short entry thread Pg

Einteiliger Einschnittring  
Nicht durchgehend isolierend

One piece sealing ring  
not overall length insulated

G	$\begin{matrix} > \varnothing < \\ \text{min mm} \end{matrix}$	$\begin{matrix} > \varnothing < \\ \text{max mm} \end{matrix}$	$\begin{matrix} \varnothing \\ \text{mm} \end{matrix}$	H mm	L mm	Art.-No.	
<b>Pg 7</b>	6.0	8.0	14/16	22	5	<b>1803.07</b>	50
<b>Pg 9</b>	8.0	10.0	17/19	25	6	<b>1803.09</b>	50
<b>Pg 11</b>	10.0	12.0	20/22	26	6	<b>1803.11</b>	50
<b>Pg 13</b>	12.0	14.0	22/24	27.5	6.5	<b>1803.13</b>	50
<b>Pg 16</b>	14.0	16.0	24/27	28.5	6.5	<b>1803.16</b>	50
<b>Pg 21</b>	14.0	16.0	30/34	33	7	<b>1803.21</b>	25
<b>Pg 29</b>	24.0	26.0	40/42	36	8	<b>1803.29</b>	25
<b>Pg 36</b>	30.0	32.0	50/52	41	9	<b>1803.36</b>	10
<b>Pg 42</b>	39.0	41.0	57/59	45	10	<b>1803.42</b>	10
<b>Pg 48</b>	45.0	47.0	64/64	48	10	<b>1803.48.48</b>	10



# Stopfbuchsen Messing mit Trompete und Klemmbacken

## Cable glands nickel-plated brass with trumpet and clamps

### Kurzes Anschlussgewinde metrisch | Short entry thread metric

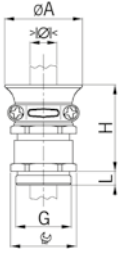

Material: Messing vernickelt  
 Dichtung: NBR  
 Schutzart: IP 54  
 Einsatztemperatur: -20 °C / +80 °C

Material: Nickel-plated brass  
 Seal: NBR  
 Protection class: IP 54  
 Operation temperature: -20 °C / +80 °C



Einteiliger Einschnittring  
 Nicht durchgehend isolierend

One piece sealing ring  
 not overall length insulated

G	> Ø < min mm	> Ø < max mm	 mm	H mm	L mm	ØA mm	Art.-No.	
<b>M16x1.5</b>	6.0	8.0	18/17	29	5	22	<b>1801.17</b>	50
<b>M20x1.5</b>	8.0	10.0	22/20	31	6	26	<b>1801.20.10</b>	50
<b>M20x1.5</b>	10.0	12.0	22/22	32	6	29	<b>1801.20.12</b>	50
<b>M20x1.5</b>	12.0	14.0	22/24	34	6	32	<b>1801.20.14</b>	50
<b>M25x1.5</b>	15.0	17.0	30/30	37	7	38	<b>1801.25</b>	50
<b>M32x1.5</b>	24.0	26.0	40/41	43	8	50	<b>1801.32</b>	25

### Kurzes Anschlussgewinde Pg | Short entry thread Pg



Einteiliger Einschnittring  
 Nicht durchgehend isolierend

One piece sealing ring  
 not overall length insulated

G	> Ø < min mm	> Ø < max mm	 mm	H mm	L mm	ØA mm	Art.-No.	
<b>Pg 9</b>	6.0	9.0	17	29	6	22	<b>1801.09</b>	50
<b>Pg 11</b>	8.0	12.0	20	31	6	26	<b>1801.11</b>	50
<b>Pg 13</b>	9.0	14.0	22	32	6	29	<b>1801.13</b>	50
<b>Pg 16</b>	10.0	16.0	24	34	6	32	<b>1801.16</b>	50
<b>Pg 21</b>	14.0	21.0	30	37	7	38	<b>1801.21</b>	50
<b>Pg 29</b>	18.0	30.0	40	43	8	50	<b>1801.29</b>	25

# Stopfbuchsen Messing mit Schutztülle und Klemmbacken

## Cable glands nickel-plated brass with antikink nozzle and clamps

### Kurzes Anschlussgewinde metrisch | Short entry thread metric

Material: Messing vernickelt  
 Dichtung: NBR  
 Knickschutztülle: NBR  
 Schutzart: IP 65 wenn Anschluss-  
 gewinde abgedichtet  
 Einsatztemperatur: -20 °C / +80 °C

Material: Nickel-plated brass  
 Seal: NBR  
 antikink nozzle: NBR  
 Protection class: IP 65 if the entry thread is  
 sealed  
 Operation temperature: -20 °C / +80 °C

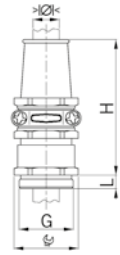

Einteiliger Einschnittring  
 Nicht durchgehend isolierend

One piece sealing ring  
 not overall length insulated

G	$\begin{matrix} > \varnothing < \\ \text{min mm} \end{matrix}$	$\begin{matrix} > \varnothing < \\ \text{max mm} \end{matrix}$	$\begin{matrix} \varnothing \\ \text{mm} \end{matrix}$	H	L	Art.-No.	
	min mm	max mm	mm	mm	mm		
M12x1.5	3.5	5.0	14/15	43	5	1852.12.05	25
M16x1.5	5.5	7.0	17/18	44	6	1852.16.07	25
M20x1.5	5.5	7.0	20/22	49	6	1852.20.07	25
M20x1.5	7.5	9.0	20/22	49	6	1852.20.09	25
M20x1.5	9.0	11.0	22/22	54	6	1852.20.11	25
M20x1.5	11.0	13.0	22/22	54	6	1852.20.13	25
M20x1.5	13.0	15.0	24/24	58	6	1852.20.15	25
M25x1.5	13.5	15.0	30/30	71	7	1852.25.15	25
M25x1.5	15.0	17.0	30/30	71	7	1852.25.17	25
M25x1.5	17.0	19.0	30/30	71	7	1852.25.19	25
M25x1.5	18.0	20.0	30/30	71	7	1852.25.20	25
M32x1.5	21.0	23.0	40/40	81	8	1852.32.23	1
M32x1.5	23.0	25.0	40/40	81	8	1852.32.25	1
M40x1.5	23.0	26.0	50/50	99	9	1852.40.26	1
M40x1.5	27.0	30.0	50/50	99	9	1852.40.30	1
M40x1.5	30.0	33.0	50/50	99	9	1852.40.33	1
M40x1.5	32.0	35.0	50/50	99	9	1852.40.35	1



### Kurzes Anschlussgewinde Pg | Short entry thread Pg

Einteiliger Einschnittring  
 Nicht durchgehend isolierend

One piece sealing ring  
 not overall length insulated

G	$\begin{matrix} > \varnothing < \\ \text{min mm} \end{matrix}$	$\begin{matrix} > \varnothing < \\ \text{max mm} \end{matrix}$	$\begin{matrix} \varnothing \\ \text{mm} \end{matrix}$	H	L	Art.-No.	
	min mm	max mm	mm	mm	mm		
Pg 7	3.5	5.0	14/16	46	5	1852.07.05	50
Pg 9	5.5	7.0	17/19	45	6	1852.09.07	50
Pg 11	5.5	7.0	20/22	45	6	1852.11.07	50
Pg 11	7.5	9.0	20/22	49	6	1852.11.09	50
Pg 13	7.5	9.0	22/24	54	6	1852.13.09	25
Pg 13	9.0	11.0	22/24	54	6	1852.13.11	25
Pg 13	11.0	13.0	22/24	54	6	1852.13.13	25
Pg 16	11.5	13.0	24/27	58	6	1852.16.13	25
Pg 16	13.0	15.0	24/27	58	6	1852.16.15	25
Pg 21	13.5	15.0	30/34	71	7	1852.21.15	25
Pg 21	15.0	17.0	30/34	71	7	1852.21.17	25
Pg 21	17.0	19.0	30/34	71	7	1852.21.19	25
Pg 21	18.0	20.0	30/34	71	7	1852.21.20	25
Pg 29	18.0	20.0	40/42	71	8	1852.29.20	1
Pg 29	21.0	23.0	40/42	82	8	1852.29.23	1
Pg 29	23.0	25.0	40/42	82	8	1852.29.25	1
Pg 36	23.0	26.0	50/52	101	9	1852.36.26	1
Pg 36	27.0	30.0	50/52	101	9	1852.36.30	1
Pg 36	30.0	33.0	50/52	99	9	1852.36.33	1
Pg 36	32.0	35.0	50/52	99	9	1852.36.35	1
Pg 42	32.0	35.0	57/62	104	10	1852.42.35	1
Pg 42	35.0	38.0	57/62	104	10	1852.42.38	1
Pg 42	36.0	40.0	57/62	104	10	1852.42.40	1













	Progress® EMV Messing Progress® EMC nickel-plated brass	EMV easyCONNECT EMC easyCONNECT	EMV Rapid EMC Rapid	EMV Standard EMC Standard	EMV für Hochtemperatur EMC for high-temperature applications	EMV mit Knickschutzfeder EMC with anti-kink-spring	EMV powerCONNECT EMC powerCONNECT	EMV Serie 85 EMC Series 85	EMV Kombi-Schlauchverschraubung EMC combination conduit gland	EMV Hohlgeflechtsverschraubung EMC conduit gland for braidings	EMV Zubehör EMC Accessories	EMV Gegenmutter mit Schneidzähnen EMC locknut with cutting teeth	Erdungsflaschen Grounding connectors
<b>Ausführung / Design</b>													
Kompressionstechnik Compression technology		•	•	•	•	•	•	•	•	-		-	-
<b>EMV Technik / EMC technology</b>													
Kontaktscheibe Contact disc		-	•	-	-	-	-	-	-	-		-	-
Kontaktfeder Contact spring		•	-	-	-	-	-	-	-	-		-	-
Kontakthülse Contact sleeve		-	•	•	•	•	-	-	•	•		-	-
Presshülse Compression ring		-	-	-	-	-	•	-	-	-		-	-
Spannzange Collet chuck		-	-	-	-	-	-	•	-	-		-	-
<b>Gewinde / Thread</b>													
Kurzes Anschlussgewinde (Standard) Short entry thread (standard)		•	•	•	•	•	•	•	A	A		•	•
Langes Anschlussgewinde Long entry thread		•	•	•	•	A	•	A	•	•		-	-
Anschlussgewinde Pg Pg entry thread		A	•	•	•	•	A	A	•	A		•	•
<b>Dichteinsatz / Sealing insert</b>													
Für Rundkabel For round cables		•	•	•	•	•	•	•	•	•		-	-
Für Schläuche For conduits		-	-	-	-	-	-	-	•	•		-	-
Einteiliger Dichteinsatz One-piece sealing insert		A	•	•	•	•	A	A	•	A		-	-
Zweiteiliger Dichteinsatz Two-piece sealing insert		•	-	-	-	-	•	•	-	-		-	-
Multi-Dichteinsatz Sealing insert for several cables		•	-	-	A	-	-	-	-	-		-	-
TPE-Dichteinsatz (Standard) TPE sealing insert (standard)		•	•	•	-	•	•	•	•	-		-	-
FPM-Dichteinsatz FPM sealing insert		A	A	-	•	A	A	A	A	-		-	-
Dichteinsatz nach EN 45545 Sealing insert acc. to EN 45545		A	A	A	-	A	•	•	-	-		-	-
<b>Anwendung / Application</b>													
Zugentlastung Strain relief		•	•	•	•	•	•	•	•	-		-	-
Knickschutz Anti-kink protection		-	-	-	-	•	-	-	-	-		-	-
Schirmgeflecht wird weitergeführt With continuation of braided shield		•	•	-	-	-	-	•	-	-		-	-
Schirmgeflecht wird nicht weitergeführt Without continuation of braided shield		•	•	•	•	•	•	•	•	•		-	-
Variabler Schirm-Klemmbereich Variable shield clamping range		+++	++	+	+	+	+++	+	+	+		-	-
Niedrige Transferimpedanz Low transfer impedance		++	+	++	++	++	+++	+++	++	++		-	-
Hohe Ableitströme (1.6 kA - 3 kA) High leakage currents (1.6 kA - 3 kA)		-	-	-	-	-	+++	+++	-	-		-	-
Demontierbarkeit ohne Beschädigung des Kabelschirms Can be removed without damaging the shield		+++	-	+	+	+	++	++	-	-		-	-
Installationsfreundlichkeit (kleiner Zeitaufwand) Easy installation (quick assembly)		++	+++	+	+	+	+	+	+	+		-	-

• trifft zu / lieferbar applies / available    - trifft nicht zu / nicht lieferbar does not apply / not available    +++ hervorragend geeignet extremely well suited    ++ sehr gut geeignet very well suited    + gut geeignet well suited    A auf Anfrage upon request



<p>Kabelverschraubungen Progress® EMV easyCONNECT Messing mit Kontaktfeder                  Cable glands Progress® EMC easyCONNECT nickel-plated brass with contact spring</p>		<p><b>95-97</b></p>	<p>1</p>
<p>Kabelverschraubungen Progress® EMV Rapid Messing mit Kontaktscheibe                  Cable glands Progress® EMC Rapid nickel-plated brass with contact disc</p>		<p><b>98 - 99</b></p>	<p>2</p>
<p>Kabelverschraubungen Progress® EMV Messing mit Kontakthülse                  Cable glands Progress® EMC nickel-plated brass with contact sleeve</p>		<p><b>100 - 103</b></p>	<p>3</p>
<p>Kabelverschraubungen Progress® EMV Messing mit Kontakthülse für hohe Temperaturen                  Cable glands Progress® EMC nickel-plated brass with contact sleeve for high temperature applications</p>		<p><b>104 - 105</b></p>	<p>5</p>
<p>Kabelverschraubungen Progress® EMV Messing mit Knickschutzfeder                  Cable glands Progress® EMC nickel-plated brass with antikink spring</p>		<p><b>106 - 107</b></p>	<p>6</p>
<p>Kabelverschraubungen Progress® EMV powerCONNECT Messing                  Cable glands Progress® EMC powerCONNECT nickel-plated brass</p>		<p><b>108</b></p>	<p>7</p>
<p>Kabelverschraubungen Progress® EMV Serie 85 Messing mit Spannzange                  Cable glands Progress® EMC Series 85 nickel-plated brass with collet chuck</p>		<p><b>109 - 110</b></p>	<p>9</p>
<p>Zubehör zu EMV-Kabelverschraubungen                  EMC cable gland accessories</p>		<p><b>111 - 112</b></p>	<p>10</p>

11

12

13

14

15

# EMV Kabelverschraubungen Progress® Messing EMC cable glands Progress® nickel-plated brass



**Die elektromagnetische Verträglichkeit (EMV)** im industriellen Umfeld besitzt einen besonderen Stellenwert, da gerade komplexe Maschinen und Anlagen äusserst anfällig für elektromagnetische Störungen sind. Den unerwünschten EMV-Effekten lässt sich jedoch mit einer wirkungsvollen Schirmung aller Komponenten entgegensteuern. Eine gute Schirmung reduziert einerseits die Störaussendung eines elektrischen Betriebsmittels und verringert gleichzeitig dessen Anfälligkeit für elektromagnetische Beeinträchtigungen.

Allerdings müssen nicht nur die Kabel selbst, sondern auch die restlichen Installationskomponenten einen Schirmcharakter aufweisen. Kabelverschraubungen als passive Bauteile müssen sicherstellen, dass die Qualität der Schirmung an den sensiblen Verbindungsstellen erhalten bleibt und es keine Schirmungsverluste gibt. Insofern ist es notwendig, nicht nur eine maximal geschirmte Leitung zu verwenden, sondern auch EMV-gerechte Kabelverschraubungen einzusetzen. Obwohl für diese Bauteile keine eigenständige EMV-Norm existiert, tragen sie wesentlich dazu bei, dass die vorgeschriebenen EMV-Auflagen der Hersteller erfüllt werden können.

Mit sechs unterschiedlichen, EMV-gerechten Kabelverschraubungen bieten wir dem Kunden das passende Produkt und die ideale Kontaktierungsvariante für jeden Anwendungsfall. Bei der Kabelverschraubung Progress® EMV easyCONNECT und auch easyCONNECT Multi Messing erfolgt die Kontaktierung über eine innovative Federklammer. Bei der neuen Progress® EMV powerCONNECT garantiert die fortschrittliche Presshülse eine sichere 360° Schirmkontaktierung auf kleinstem Raum.

**Alle Produktreihen zeichnen sich durch eine leichte Montage aus.** AGRO EMV-Kabelverschraubungen weisen ausserdem eine niedrige Transferimpedanz und hohe Strombelastbarkeit aus. Beides sind gängige Gütekriterien für die Qualität einer Schirmung.

**Electromagnetic compatibility (EMC)** plays a key role in the industrial sector because complex machines and systems are extremely susceptible to electromagnetic interference. Such undesired EMC effects, however, can be counteracted by ensuring effective shielding of all components. Good shielding reduces the amount of interference emitted by an electrical apparatus while at the same time reducing its own susceptibility to electromagnetic interference.

Not only the cables themselves but also all other components that are part of the installation must be adequately shielded. As passive components, cable glands must ensure that the quality of the shielding at sensitive interconnection points is maintained and that there are no shielding losses. For this reason, it is necessary not only to use an optimally shielded cable but also to use EMC-compatible cable glands. Although there is no stand-alone EMC standard for these components, they contribute strongly towards making it possible to meet the EMC requirements specified by manufacturers.

With six different EMC-compatible cable glands, we offer our customers the appropriate product and the ideal type of contact for each application. With the Progress® EMC easyCONNECT and easyCONNECT Multi brass cable glands, contact is established by means of an innovative spring clip. With the new Progress® EMC powerCONNECT cable gland, its advanced compression ring ensures reliable 360° shield contact in a very compact unit.

**All these product lines are characterised by their ability to be easily installed.** AGRO EMC cable glands also exhibit low transfer impedance and high current – carrying capacity – both of which are well-established criteria for the quality of shielding.

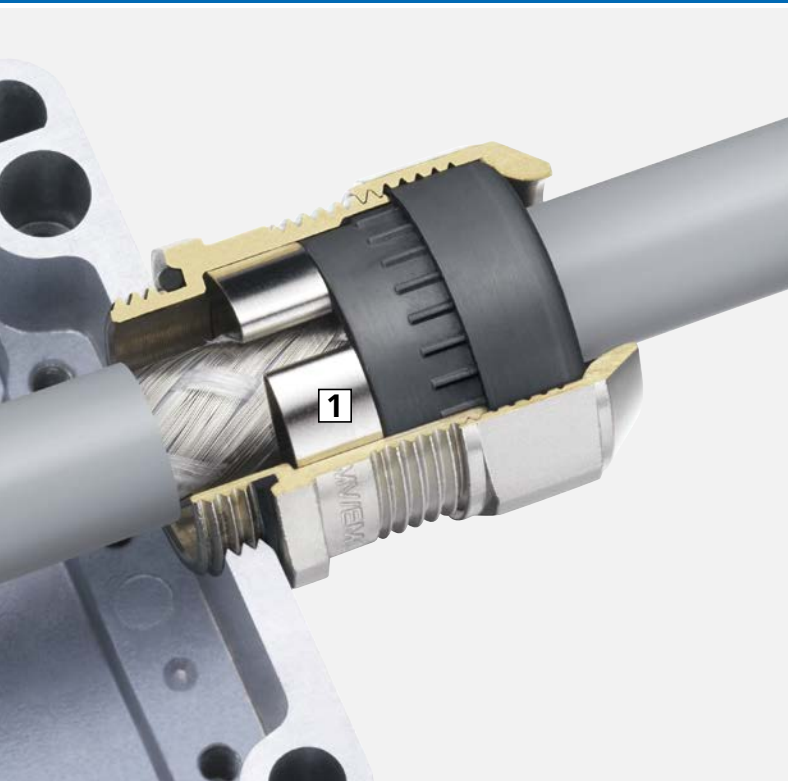

### Progress® EMV easyCONNECT Messing

Die **Kabelverschraubung Progress® EMV easyCONNECT** gewährleistet volle Installationskontrolle und gleicht Toleranzen in den Schirmdicken für einen sicheren Schirmabgriff aus. Das Federsystem ermöglicht eine gute und sichere Schirmkontaktierung sowohl bei partiell abisolierten Abschirmkabeln als auch bei vollständig freigelegten Kabelschirmen.

#### 1 Optimale Schirmkontaktierung

Die kraftvolle, schonende Klemmung des Kabelschirms garantiert einen hervorragenden Schirmkontakt und sorgt für extrem niedrige Transferimpedanzen. Durch die spezielle Formgebung der Kontaktfeder ist nicht nur ein grosser Schirmklemmbereich, sondern auch die Demontierbarkeit der Kabelverschraubung ohne Zerstörung des EMV-Geflechtes gegeben.

### Progress® EMC easyCONNECT nickel-plated brass

The **Progress® EMC easyCONNECT cable gland** ensures full control during installation and compensates for tolerances in shield thickness to ensure a reliable shield grip. The spring system facilitates good, reliable shield contact for either partially or fully stripped shielded cables.

#### 1 Optimal shield contact

The strong, cable-friendly clamping of the cable shield ensures excellent shield contact and extremely low transfer impedance. The shape of the contact spring facilitates not only a large shield clamping range but also easy removal of the cable gland without damaging the EMC braiding.

### Progress® EMV easyCONNECT Multi

Die **Progress® easyCONNECT Multi** ist die erste Kabelverschraubung, die das Einführen von mehreren geschirmten Kabeln in ein Gehäuse erlaubt – und dies mit kraftvollem und sicherem Schirmabgriff.

Bei einem kleinen Installationsraum für geschirmte Leitungen ist die Progress® EMV easyConnect Multi genau das richtige. Egal, ob die zu verarbeitenden Kabel immer den gleichen oder unterschiedliche Durchmesser aufweisen, ob es sich um vorkonfektionierte oder unkonfektionierte Leitungen oder Hybridkabel handelt: Durch die innovative Kontaktfeder ist eine problemlose Erdung möglich.

### Progress® EMC easyCONNECT Multi

**Progress® easyCONNECT Multi** is the first cable gland that allows for the entry of multiple shielded cables into a housing or cabinet while ensuring a strong, reliable shield grip.

For shielded cables that require to be installed where space is limited, Progress® EMC easyCONNECT Multi is the perfect solution. Whether for cables of the same or different diameters, or for preassembled, non-preassembled or hybrid cables: The innovative contact spring facilitates problem-free earthing.

# Sechs unterschiedliche Kontaktierungsvarianten

## Six different contact types

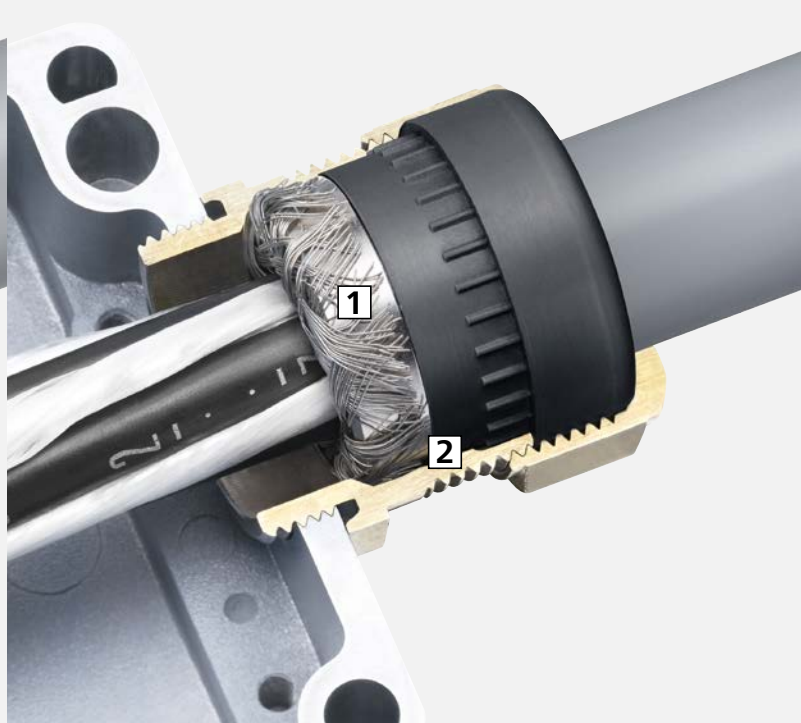
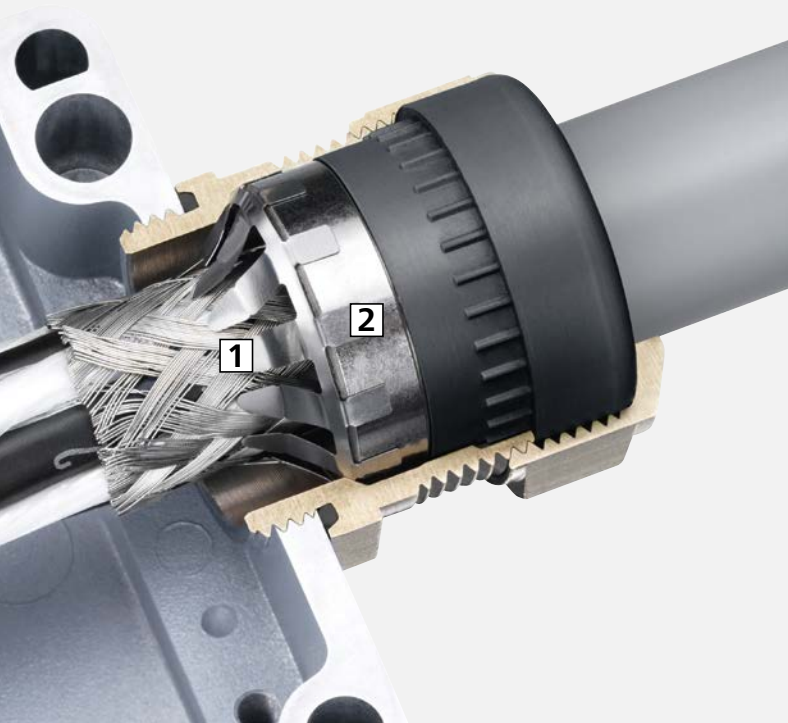

### Progress® EMV Rapid Messing

Die **Kabelverschraubung mit den zwei Kontaktierungsvarianten** für eine sehr schnelle und einfache Schirmkontaktierung durch eine integrierte Kontaktscheibe. Sie ermöglicht die gute Kontaktierung sowohl von partiell abisolierten Abschirmkabeln als auch von vollständig freigelegten Kabelschirmen, die auch weitergeführt werden können.

#### 1 Niedriger Übergangswiderstand

Die grossflächigen, flexiblen Zungen der Kontaktscheibe maximieren die Abgriffsfläche am Schirmgeflecht und erlauben eine zeitsparende Montage.

#### 2 Flexible Kontaktierungsmöglichkeiten

Für eine höherwertige 360° Schirmkontaktierung, kann die Kontaktscheibe ausgestossen werden und das zugeschnittene Schirmgeflecht über die Kontakthülse direkt mit der Kontaktfläche im Unterteil der Kabelverschraubung kontaktiert werden.

### Progress® EMC Rapid nickel-plated brass

The **cable gland with two contact options**, facilitating quick and easy shield contact by means of an integrated contact element with flexible protruding strips. This enables good contact to be achieved with partially stripped shielded cables or with fully exposed cable shields, which may also be extended.

#### 1 Low contact resistance

The contact element's large, flexible protruding strips maximise the gripping area on the shield braiding, facilitating time-saving installation.

#### 2 Flexible possibilities for creating the contact

For a superior 360°-contact, the contact element can be pushed out and the trimmed shield can be placed directly against the contact surface on the cable gland's lower part, via the contact sleeve.

### Progress® EMV Messing

**Kabelverschraubungen Progress® EMV aus Messing mit der bewährten Kontakthülse** ermöglichen eine Schirmkontaktierung von 360° bei in der Kabelverschraubung endendem Schirmgeflecht. Die massgebende Kantengeometrie der Kontakthülse verhindert hierbei ein Abscheren des Schirmgeflechts.

#### 1 Kleinste Übergangswiderstände

Der konzentrische Schirmabgriff von 360° bürgt für kleinste Übergangswiderstände.

#### 2 Permanenter Kontaktdruck

Die ineinandergreifende Kombination „Dichteinsatz-Kontakthülse“ garantiert einen permanenten Kontaktdruck des Schirmgeflechts am Unterteil.

### Progress® EMC nickel-plated brass

The **Progress® EMC cable gland of brass with its well-proven contact sleeve** facilitates 360°-contact with shield braiding that ends in the cable gland. The appropriate edge geometry of the contact sleeve prevents any shearing off of the shield braiding.

#### 1 Extremely low contact resistance

The concentric 360° shield grip ensures very low contact resistance.

#### 2 Constant contact pressure

The interlocking "sealing insert/contact sleeve" combination ensures constant and enduring contact pressure between the shield braiding and the cable gland's lower part.

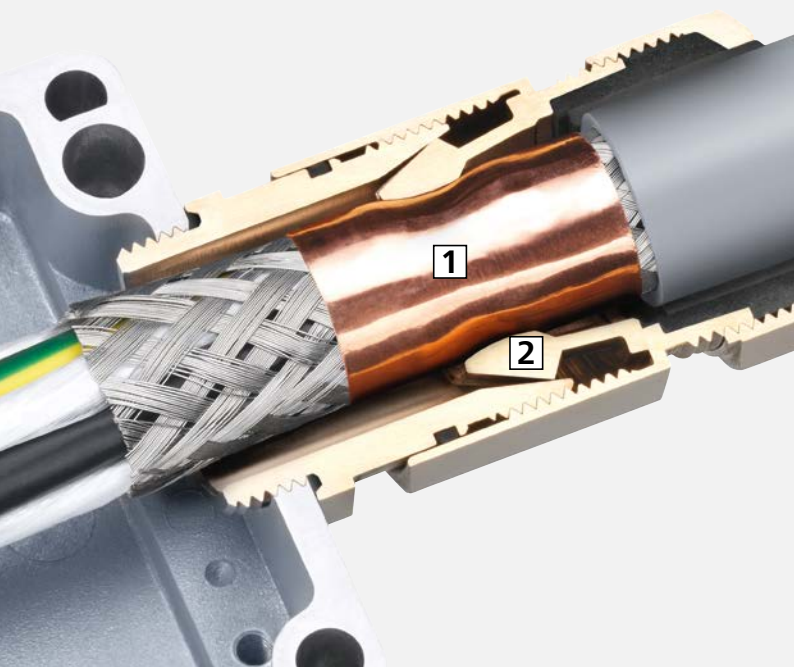

### Progress® EMV Serie 85 Messing

Die patentierten Kabelverschraubungen **Progress® EMV Serie 85** aus Messing sorgen für eine besonders niederimpedante Verbindung zwischen Schirmgeflecht und Metallgehäuse bei gleichzeitig sicherer Kabeleinführung.

#### 1 Optimale Schirmkontaktierung

Das Zwischenstück mit den grossen Schlüssel­flächen ermöglicht eine einwandfreie Kontaktierung des Schirmgeflechtes durch die wegverstärkenden Spannzangensegmente über 360°. Das Kupferband sorgt für eine gleichmässige Kraftverteilung der Spannzange auf das Schirmgeflecht.

#### 2 Höchste Ableitströme

Die massive Spannzange gewährleistet einen konzentrischen, niederimpedanten Schirmabgriff und bewältigt dauerhaft Ableitströme bis 1.6 kA – kurzzeitig 3 kA.

### Progress® EMC Series 85 of nickel-plated brass

The patented **Progress® EMC Series 85** of nickel-plated brass provides an especially low-impedance connection between braided shield and metal cabinet while ensuring safe and reliable cable entry.

#### 1 Optimal shield contact

The intermediate piece with the large spanner flats facilitates flawless 360° contact of the braided shield by means of the collet chuck design with its protrusions of increasing thickness with distance from the free end. The copper sheeting around the braided shield provides for an even distribution of force from the collet chuck.

#### 2 Very high leakage currents

The compact collet chuck element ensures a concentric, low-impedance shield grip and can handle continuous leakage currents of up to 1.6 kA – and short term of up to 3 kA.

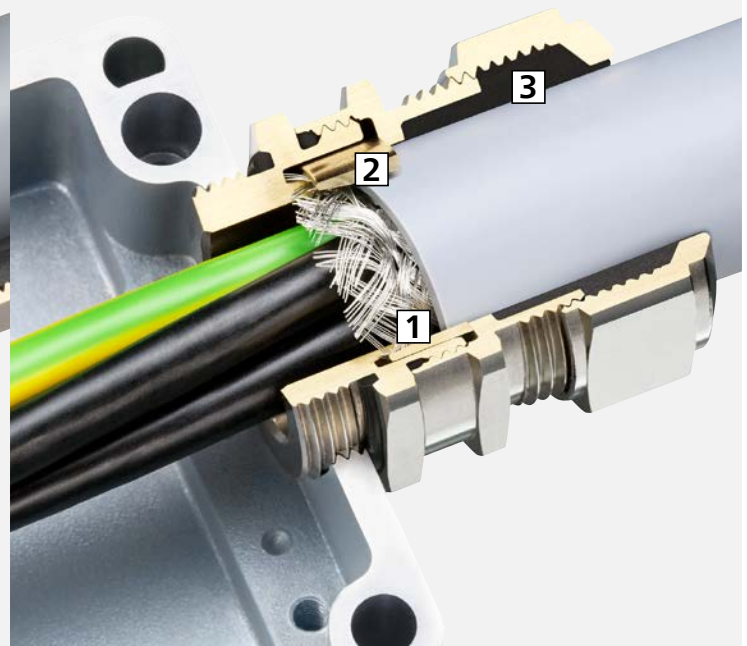

### Progress® EMV powerCONNECT

Die **Progress® EMV powerCONNECT** mit der neuartigen fortschrittlichen Presshülse garantiert eine sichere 360° Schirmkontaktierung. Der direkte Übergang vom Geflecht auf das Unterteil der Kabelverschraubung gewährleistet einen erstaunlich niedrigen Übergangswiderstand. Dank geringer Bauhöhe eignet sich die Verschraubung ideal für den Einsatz in kleinstem Raum.

#### 1 Geringe Übergangswiderstände

Durch den direkten Kontakt Geflecht-Kabelverschraubungskonus ergeben sich äusserst geringe Übergangswiderstände.

#### 2 Höchste Ableitströme

Dauerhaft hoher Kontaktdruck durch die fixierte Presshülse und das Anziehen des Zwischenstücks auf Block ermöglichen höchste Ableitströme welche nur durch den Schirmquerschnitt begrenzt werden.

#### 3 Grosse Flexibilität

Hohe Dichtigkeit bei grosser Flexibilität. Die zweiteiligen Dichteinsätze ermöglichen eine grosse Bandbreite im Klemmbereich bei unveränderter Schutzart (IP 68 / IP 69).

### Progress® EMC powerCONNECT

The **Progress® EMC powerCONNECT cable gland**, with its innovative, highly advanced compression ring design, ensures reliable 360° shield contact. The direct transition from the braiding to the cable gland's lower part ensures very low contact resistance. Thanks to the compactness of its design, this cable gland is ideal for use where space is very limited.

#### 1 Low contact resistance

As a result of the direct contact between the cable's shielding and the cable gland's tapered element, contact resistance is very low.

#### 2 Very high leakage currents

Lasting high contact pressure from the fixed compression ring and full tightening of the middle piece maximises the grounding of leakage currents, limited only by the shield's cross-sectional area.

#### 3 High flexibility

Excellent sealing performance with high flexibility. The two-part sealing inserts facilitate a wide clamping range for a particular protection class (IP 68 / IP 69).

### Progress® EMV easyCONNECT Multi

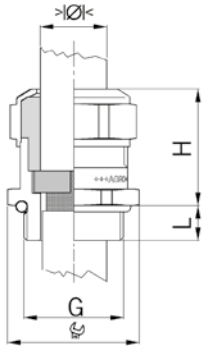

Material: Messing vernickelt  
 Kontaktfeder: Federstahl 1.4310  
 Dichtung: TPE  
 O-Ring: NBR  
 Zugentlastung: Ausführung A nach EN 62444  
 Einsatztemperatur: -40°C / +100°C  
 Schutzart: IP 68 (bis 10 bar) / IP 69  
 Anwendungen: Für zeitsparende und sichere Montage von partiell abisolierten sowie durchgehend geschirmten Kabeln

Material: Nickel-plated brass  
 Contact spring: Spring steel 1.4310  
 Seal: TPE  
 O-ring: NBR  
 Strain relief: Version A acc. to EN 62444  
 Temperature range: -40°C to +100°C  
 Protection class: IP 68 (up to 10 bar) / IP 69  
 Applications: For quick and reliable installation of partially stripped cables or continuously shielded cables



Einteiliger Dichteinsatz  
 nicht durchgehend isolierend

One-piece sealing insert  
 Not continuously isolating

Bei einem kleinen Installationsraum für geschirmte Leitungen ist Progress® EMV easyConnect Multi genau das richtige. Egal, ob die zu verarbeitenden Kabel immer den gleichen oder unterschiedliche Durchmesser aufweisen, ob es sich um vorkonfektionierte oder unkonfektionierte Leitungen oder Hybridkabel handelt: Durch die innovative Kontaktfeder ist eine problemlose Erdung möglich. Anhand der aufgeführten Bilder sehen Sie nur einen kleinen Ausschnitt der vielen Möglichkeiten.

For shielded cables in limited space conditions, Progress® EMC easyConnect Multi is the perfect solution. Whether for cables of the same or different diameters, or for preassembled, non-preassembled or hybrid cables: The innovative contact spring facilitates problem-free earthing. The presented pictures show only a small selection of the many possibilities.

You specify the number of cable entries and the relevant diameters, and we will supply the EMC Multi cable gland to meet your needs.

Sie definieren Anzahl und Durchmesser der Kabeleinführungen – wir liefern Ihnen Ihre individuelle EMV-Multi-Kabelverschraubung.

Auf Anfrage lieferbar:  
 Ausführungen in Stahl A2 und A4  
 Anschlussgewinde Pg und NPT  
 Mit FPM-Dichteinsätzen für hohe Temperaturen  
 Mit F-Dichteinsätzen nach EN 45545

Available on request:  
 Versions in A2 or A4 steel  
 Entry thread Pg or NPT  
 With FPM sealing inserts for high temperatures  
 With sealing inserts of type F in accordance with EN 45545



Mit Standard Bohrungen  
 With standard hole layouts



Mit individuellen Bohrungen  
 With customized hole layouts

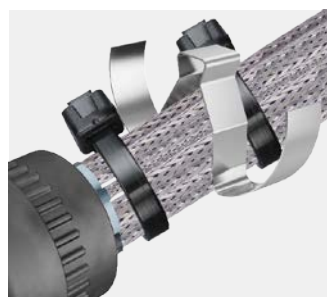
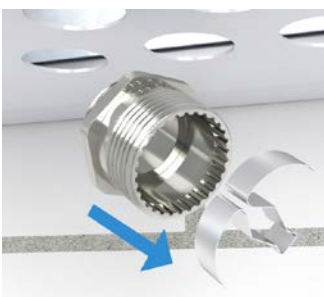

# Kabelverschraubungen Progress® EMV easyCONNECT Messing mit Kontaktfeder Cable glands Progress® EMC easyCONNECT nickel-plated brass with contact spring

## Kurzes Anschlussgewinde metrisch | Short entry thread metric

Material:	Messing vernickelt	Material:	Nickel-plated brass
Kontaktfeder:	Federstahl 1.4310	Contact spring:	Spring steel 1.4310
Dichtung:	TPE	Seal:	TPE
O-Ring:	NBR	O-ring:	NBR
Zugentlastung:	Ausführung A nach EN 62444	Strain relief:	Version A acc. to EN 62444
Schutzart:	IP 68 (bis 10 bar) / IP 69	Protection class:	IP 68 (up to 10 bar) / IP 69
NEMA Type rating:	4X	NEMA Type rating:	4X
Eigenschaften:	Für zeitsparende und sichere Montage von partiell abisolierten sowie durchgehend geschirmten Kabeln	Properties:	For a quick and safe installation of partially dismantled cables as well as thoroughly shielded cables
Einsatztemperatur:	-60 °C / +100 °C	Operation temperature:	-60 °C / +100 °C



Zweiteiliger Dichteinsatz Nicht durchgehend isolierend		Two-piece sealing insert not overall length insulated									
G	>10< min mm	>10< max mm	>10< min mm	>10< max mm	>10< mm	H mm	L mm	i info	Art.-No.		
M12x1.5	-	-	3.5	5.0	2.5-5.5	15	22	5	1	1083.12.050	50
M12x1.5	-	-	5.0	6.5	2.5-5.5	15	22	5	1	1083.12.065	50
M16x1.5	6.0	8.0	8.0	10.5	4.5-8.5	18	25	5	-	1083.17	50
M20x1.5	8.0	11.0	11.0	15.0	6.0-12.0	24	27	6	-	1083.20	50
M25x1.5	12.5	16.0	16.0	20.5	9.5-17.0	30	33	7	-	1083.25	25
M32x1.5	17.0	21.0	21.0	25.5	14.0-21.0	36	33	8	-	1083.32	25
M40x1.5	24.0	28.5	28.5	33.0	20.5-29.0	46	38	8	-	1083.40	10
M50x1.5	33.0	37.0	37.0	42.0	28.0-36.0	55	42	9	-	1083.50	10
M63x1.5	40.0	46.0	46.0	52.0	35.0-46.0	70	42	10	-	1083.63	5

  

1 = Einteiliger Dichteinsatz	1 = One-piece sealing insert
Erhältlich mit Dichteinsatz gemäss EN 45545 / NFPA 130. Bei Anfragen oder Bestellung bitte ein F vor die Artikelnummer setzen.	Available with sealing inserts conformity with EN 45545 / NFPA 130. When placing an inquiry, prefix the article number by the capital F.
Auf Anfrage lieferbar:	Available on request:
Anschlussgewinde Pg und NPT	Entry thread Pg and NPT



# Kabelverschraubungen Progress® EMV easyCONNECT Messing mit Kontaktfeder Cable glands Progress® EMC easyCONNECT nickel-plated brass with contact spring

## Langes Anschlussgewinde metrisch | Long entry thread metric

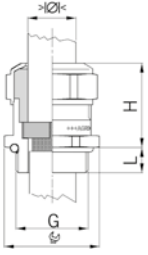

Material: Messing vernickelt  
 Kontaktfeder: Federstahl 1.4310  
 Dichtung: TPE  
 O-Ring: NBR  
 Zugentlastung: Ausführung A nach EN 62444  
 Schutzart: IP 68 (bis 10 bar) / IP 69  
 NEMA Type rating: 4X  
 Eigenschaften: Für zeitsparende und sichere Montage von partiell abisolierten sowie durchgehend geschirmten Kabeln  
 Einsatztemperatur: -60 °C / +100 °C

Material: Nickel-plated brass  
 Contact spring: Spring steel 1.4310  
 Seal: TPE  
 O-ring: NBR  
 Strain relief: Version A acc. to EN 62444  
 Protection class: IP 68 (up to 10 bar) / IP 69  
 NEMA Type rating: 4X  
 Properties: For a quick and safe installation of partially dismantled cables as well as thoroughly shielded cables  
 Operation temperature: -60 °C / +100 °C



Progress  
EMV easyCONNECT



Zweiteiliger Dichteinsatz  
Nicht durchgehend isolierend

Two-piece sealing insert  
not overall length insulated

G	Ø		Ø		■		⚙	H	L	i	Art.-No.	📦
	min mm	max mm	min mm	max mm	mm		mm	mm	mm	info		
M12x1.5	-	-	3.5	5.0	2.5-5.5		15	22	10	1	1183.12.050	50
M12x1.5	-	-	5.0	6.5	2.5-5.5		15	22	10	1	1183.12.065	50
M16x1.5	6.0	8.0	8.0	10.5	4.5-8.5		18	25	10	-	1183.17	50
M20x1.5	8.0	11.0	11.0	15.0	6.0-12.0		24	27	10	-	1183.20	50
M25x1.5	12.5	16.0	16.0	20.5	9.5-17.0		30	33	11	-	1183.25	25
M32x1.5	17.0	21.0	21.0	25.5	14.0-21.0		36	33	13	-	1183.32	25
M40x1.5	24.0	28.5	28.5	33.0	20.5-29.0		46	38	13	-	1183.40	10
M50x1.5	33.0	37.0	37.0	42.0	28.0-36.0		55	42	14	-	1183.50	10
M63x1.5	40.0	46.0	46.0	52.0	35.0-46.0		70	42	14	-	1183.63	5

1 = Einteiliger Dichteinsatz

1 = One-piece sealing insert

Erhältlich mit Dichteinsatz gemäss EN 45545 / NFPA 130. Bei Anfragen oder Bestellung bitte ein F vor die Artikelnummer setzen.

Available with sealing inserts conformity with EN 45545 / NFPA 130. When placing an inquiry, prefix the article number by the capital F.

Auf Anfrage lieferbar:

Available on request:

Anschlussgewinde Pg und NPT

Entry thread Pg and NPT

Ausführungen in Stahl A2 und A4

Executions in steel A2 and A4

Kurzes Anschlussgewinde metrisch | Short entry thread metric

Material:	Rostfreier CrNi-Stahl A2 (DIN EN 1.4305 / AISI 303)	Material:	CrNi stainless steel A2 (DIN EN 1.4305 / AISI 303)
Kennzeichnung:	1 Rille	Identification:	1 groove
Kontaktfeder:	Federstahl 1.4310	Contact spring:	Spring steel 1.4310
Dichtung:	FPM	Seal:	FPM
O-Ring:	FPM	O-ring:	FPM
Zugentlastung:	Ausführung A nach EN 62444	Strain relief:	Version A acc. to EN 62444
Schutzart:	IP 68 (bis 10 bar) / IP 69	Protection class:	IP 68 (up to 10 bar) / IP 69
Eigenschaften:	Für zeitsparende und sichere Montage von partiell abisolierten sowie durchgehend geschirmten Kabeln	Properties:	For a quick and safe installation of partially dismantled cables as well as thoroughly shielded cables
Einsatztemperatur:	-40 °C / +200 °C	Operation temperature:	-40 °C / +200 °C



Zweiteiliger Dichteinsatz Nicht durchgehend isolierend Für hohe Temperaturen	Two-piece sealing insert not overall length insulated For high temperature applications									
<b>G</b>	<b>Art.-No.</b>									
$\begin{matrix} >Ø< \\ \text{min mm} \end{matrix}$	$\begin{matrix} >Ø< \\ \text{max mm} \end{matrix}$	$\begin{matrix} >Ø< \\ \text{min mm} \end{matrix}$	$\begin{matrix} >Ø< \\ \text{max mm} \end{matrix}$	$\begin{matrix} \text{H} \\ \text{mm} \end{matrix}$	$\begin{matrix} \text{L} \\ \text{mm} \end{matrix}$	<b>i</b>	<b>info</b>			
<b>M12x1.5</b>	-	-	3.5	5.0	17	22	7	1	<b>1083.12.96.050</b>	50
<b>M12x1.5</b>	-	-	5.0	6.5	17	22	7	1	<b>1083.12.96.065</b>	50
<b>M16x1.5</b>	6.0	8.0	8.0	10.5	19	25	7	-	<b>1083.17.96</b>	50
<b>M20x1.5</b>	8.0	11.0	11.0	15.0	24	27	8	-	<b>1083.20.96</b>	50
<b>M25x1.5</b>	12.5	16.0	16.0	20.5	30	33	8	-	<b>1083.25.96</b>	25
<b>M32x1.5</b>	17.0	21.0	21.0	25.5	36	33	9	-	<b>1083.32.96</b>	25
<b>M40x1.5</b>	24.0	28.5	28.5	33.0	46	38	9	-	<b>1083.40.96</b>	10
<b>M50x1.5</b>	33.0	37.0	37.0	42.0	55	42	10	-	<b>1083.50.96</b>	10
<b>M63x1.5</b>	40.0	46.0	46.0	52.0	70	42	10	-	<b>1083.63.96</b>	5
1 = Einteiliger Dichteinsatz								1 = One-piece sealing insert		
Auf Anfrage lieferbar:								Available on request:		
Langes Anschlussgewinde metrisch								Long entry thread metric		



1  
2  
3  
4  
5  
6  
7  
8  
9  
10  
11  
12  
13  
14  
15

# Kabelverschraubungen Progress® EMV Rapid Messing mit Kontaktscheibe

## Cable glands Progress® EMC Rapid nickel-plated brass with contact disc

### Kurzes Anschlussgewinde metrisch | Short entry thread metric

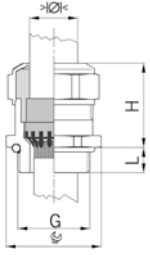

Material: Messing vernickelt  
 Kontakthülse: Messing vernickelt  
 Kontaktscheibe: Rostfreier Stahl A2  
 Dichtung: TPE  
 O-Ring: NBR  
 Zugentlastung: Ausführung A nach EN 62444  
 Schutzart: IP 68 (bis 10 bar) / IP 69  
 NEMA Type rating: 4X  
 Eigenschaften: Für zeitsparende Montage von partiell abisolierten sowie durchgehend geschirmten Kabeln  
 Einsatztemperatur: -40 °C / +100 °C

Material: Nickel-plated brass  
 Contact sleeve: Nickel-plated brass  
 Contact disc: Stainless steel A2  
 Seal: TPE  
 O-ring: NBR  
 Strain relief: Version A acc. to EN 62444  
 Protection class: IP 68 (up to 10 bar) / IP 69  
 NEMA Type rating: 4X  
 Properties: For a quick installation of partially dismantled cables as well as thoroughly shielded cables  
 Operation temperature: -40 °C / +100 °C



Progress  
MS EMV Rapid



Einteiliger Dichteinsatz  
Nicht durchgehend isolierend

One-piece sealing insert  
not overall length insulated

G	> Ø < min mm	> Ø < max mm	Ø mm	H mm	L mm	Art.-No.	
M12x1.5	4.5	6.0	15	20	5	1081.12.060	50
M12x1.5	6.0	7.5	15	20	5	1081.12.075	50
M16x1.5	6.0	8.0	18	23	5	1081.17.080	50
M16x1.5	8.0	10.0	18	25	5	1081.17.100	50
M20x1.5	8.0	11.0	24	25	6	1081.20.110	50
M20x1.5	11.0	14.0	24	27	6	1081.20.140	50
M25x1.5	13.0	16.0	30	30	7	1081.25.160	25
M25x1.5	16.0	19.0	30	33	7	1081.25.190	25
M32x1.5	18.0	21.0	36	32	8	1081.32.210	25
M32x1.5	21.0	25.0	36	32	8	1081.32.250	25

### Langes Anschlussgewinde metrisch | Long entry thread metric



Progress  
MS EMV Rapid



Einteiliger Dichteinsatz  
Nicht durchgehend isolierend

One-piece sealing insert  
not overall length insulated

G	> Ø < min mm	> Ø < max mm	Ø mm	H mm	L mm	Art.-No.	
M12x1.5	4.5	6.0	15	20	10	1181.12.060	50
M12x1.5	6.0	7.5	15	20	10	1181.12.075	50
M16x1.5	6.0	8.0	18	23	10	1181.17.080	50
M16x1.5	8.0	10.0	18	25	10	1181.17.100	50
M20x1.5	8.0	11.0	24	25	10	1181.20.110	50
M20x1.5	11.0	14.0	24	27	10	1181.20.140	50
M25x1.5	13.0	16.0	30	30	11	1181.25.160	25
M25x1.5	16.0	19.0	30	33	11	1181.25.190	25
M32x1.5	18.0	21.0	36	32	13	1181.32.210	25
M32x1.5	21.0	25.0	36	32	13	1181.32.250	25

# Kabelverschraubungen Progress® EMV Rapid Messing mit Kontaktscheibe

## Cable glands Progress® EMC Rapid nickel-plated brass with contact disc

### Kurzes Anschlussgewinde Pg | Short entry thread Pg

Material:	Messing vernickelt	Material:	Nickel-plated brass
Kontakthülse:	Messing vernickelt	Contact sleeve:	Nickel-plated brass
Kontaktscheibe:	Rostfreier Stahl A2	Contact disc:	Stainless steel A2
Dichtung:	TPE	Seal:	TPE
O-Ring:	NBR	O-ring:	NBR
Schutzart:	IP 68 (bis 10 bar) / IP 69	Protection class:	IP 68 (up to 10 bar) / IP 69
NEMA Type rating:	4X	NEMA Type rating:	4X
Eigenschaften:	Für zeitsparende Montage von partiell abisolierten sowie durchgehend geschirmten Kabeln	Properties:	For a quick installation of partially dismantled cables as well as thoroughly shielded cables
Einsatztemperatur:	-40 °C / +100 °C	Operation temperature:	-40 °C / +100 °C

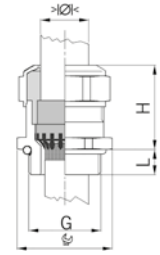

Einteiliger Dichteinsatz  
Nicht durchgehend isolierend

One-piece sealing insert  
not overall length insulated

G	$\begin{matrix} > \text{Ø} < \\ \text{min mm} \end{matrix}$	$\begin{matrix} > \text{Ø} < \\ \text{max mm} \end{matrix}$	$\begin{matrix} \text{Ø} \\ \text{mm} \end{matrix}$	H	L	Art.-No.	
	min mm	max mm	mm	mm	mm		
Pg 7	4.5	6.0	15	20	6	1081.07.060	50
Pg 7	6.0	7.5	15	20	6	1081.07.075	50
Pg 9	6.0	8.0	18	23	6	1081.09.080	50
Pg 9	8.0	10.0	18	25	6	1081.09.100	50
Pg 11	5.5	8.5	21	25	6	1081.11.085	50
Pg 11	8.5	12.0	21	25	6	1081.11.120	50
Pg 13	8.0	11.0	24	25	6	1081.13.110	50
Pg 13	11.0	14.0	24	27	6	1081.13.140	50
Pg 16	8.0	11.0	24	24	6	1081.16.110	50
Pg 16	11.0	14.0	24	27	6	1081.16.140	50
Pg 21	13.0	16.0	30	30	7	1081.21.160	25
Pg 21	16.0	19.0	30	33	7	1081.21.190	25
Pg 29	19.0	23.0	38	33	8	1081.29.230	25
Pg 29	23.0	25.5	38	32	8	1081.29.255	25



Progress  
MS EMV Rapid



### Langes Anschlussgewinde Pg | Long entry thread Pg

Einteiliger Dichteinsatz  
Nicht durchgehend isolierend

One-piece sealing insert  
not overall length insulated

G	$\begin{matrix} > \text{Ø} < \\ \text{min mm} \end{matrix}$	$\begin{matrix} > \text{Ø} < \\ \text{max mm} \end{matrix}$	$\begin{matrix} \text{Ø} \\ \text{mm} \end{matrix}$	H	L	Art.-No.	
	min mm	max mm	mm	mm	mm		
Pg 7	4.5	6.0	15	20	10	1181.07.060	50
Pg 7	6.0	7.5	15	20	10	1181.07.075	50
Pg 9	6.0	8.0	18	23	10	1181.09.080	50
Pg 9	8.0	10.0	18	25	10	1181.09.100	50
Pg 11	5.5	8.5	21	25	10	1181.11.085	50
Pg 11	8.5	12.0	21	25	10	1181.11.120	50
Pg 13	8.0	11.0	24	25	10	1181.13.110	50
Pg 13	11.0	14.0	24	27	10	1181.13.140	50
Pg 16	8.0	11.0	24	24	10	1181.16.110	50
Pg 16	11.0	14.0	24	27	10	1181.16.140	50
Pg 21	13.0	16.0	30	30	12	1181.21.160	25
Pg 21	16.0	19.0	30	33	12	1181.21.190	25
Pg 29	19.0	23.0	38	33	12	1181.29.230	25
Pg 29	23.0	25.5	38	32	12	1181.29.255	25



Progress  
MS EMV Rapid



# Kabelverschraubungen Progress® EMV Messing mit Kontakthülse

## Cable glands Progress® EMC nickel-plated brass with contact sleeve

### Kurzes Anschlussgewinde metrisch | Short entry thread metric

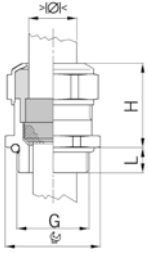

Material: Messing vernickelt  
 Kontakthülse: Messing vernickelt  
 Dichtung: TPE  
 O-Ring: NBR  
 Zugentlastung: Ausführung A nach EN 62444  
 Schutzart: IP 68 (bis 10 bar) / IP 69  
 NEMA Type rating: 4X  
 Eigenschaften: Sehr guter Schirmkontakt über die Kontakthülse bei in der Kabelverschraubung endendem Schirmgeflecht

Material: Nickel-plated brass  
 Contact sleeve: Nickel-plated brass  
 Seal: TPE  
 O-ring: NBR  
 Strain relief: Version A acc. to EN 62444  
 Protection class: IP 68 (up to 10 bar) / IP 69  
 NEMA Type rating: 4X  
 Properties: Excellent shield contact through the contact sleeve with the braided shield terminating in the screwed cable gland

Einsatztemperatur: -40 °C / +100 °C

Operation temperature: -40 °C / +100 °C



Progress MS EMV



Einteiliger Dichteinsatz  
 Nicht durchgehend isolierend

One-piece sealing insert  
 not overall length insulated

G	>math>D</math> min mm	>math>D</math> max mm	mm	H mm	L mm	i info	Art.-No.	
M8x1.25	2.5	3.5	11	15	5	1	1080.08.035	50
M8x1.25	3.0	4.0	11	15	5	1	1080.08.040	50
M10x1.5	3.0	4.0	13	16	5	1	1080.10.040	50
M10x1.5	4.0	6.0	13	16	5	1	1080.10.060	50
M12x1.5	4.5	6.0	15	20	5	-	1080.12.060	50
M12x1.5	6.0	7.5	15	20	5	-	1080.12.075	50
M16x1.5	6.0	8.0	18	23	5	-	1080.17.080	50
M16x1.5	8.0	10.0	18	25	5	-	1080.17.100	50
M20x1.5	8.0	11.0	24	25	6	-	1080.20.110	50
M20x1.5	11.0	14.0	24	27	6	-	1080.20.140	50
M25x1.5	13.0	16.0	30	30	7	-	1080.25.160	25
M25x1.5	16.0	19.0	30	33	7	-	1080.25.190	25
M32x1.5	18.0	21.0	36	32	8	-	1080.32.210	25
M32x1.5	21.0	25.0	36	32	8	-	1080.32.250	25
M40x1.5	24.0	28.5	46	34	8	-	1080.40.285	10
M40x1.5	28.5	32.0	46	34	8	-	1080.40.320	10
M50x1.5	33.0	37.0	55	36	9	-	1080.50.370	10
M50x1.5	37.0	41.0	55	36	9	-	1080.50.410	10
M63x1.5	40.0	46.0	70	39	10	-	1080.63.460	5
M63x1.5	46.0	50.0	70	39	10	-	1080.63.500	5
M75x1.5	50.0	56.0	80	40	11	-	1080.75.560	1
M80x2.0	56.0	65.0	95	45	18	-	1080.80.650	1
M85x2.0	63.0	70.0	95	45	18	-	1080.85.700	1
M95x2.0	68.0	75.0	110	52	20	-	1080.95.750	1

1 = Metrisches Regelgewinde (mit VDE Testreport)

1 = Metric coarse-pitch thread (with VDE test report)

Erhältlich mit Dichteinsatz gemäss EN 45545 / NFPA 130. Bei Anfragen oder Bestellung bitte ein F vor die Artikelnummer setzen.

Available with sealing inserts conformity with EN 45545 / NFPA 130. When placing an inquiry, prefix the article number by the capital F.

# Kabelverschraubungen Progress® EMV Messing mit Kontakthülse

## Cable glands Progress® EMC nickel-plated brass with contact sleeve

### Langes Anschlussgewinde metrisch | Long entry thread metric

Material:	Messing vernickelt	Material:	Nickel-plated brass
Kontakthülse:	Messing vernickelt	Contact sleeve:	Nickel-plated brass
Dichtung:	TPE	Seal:	TPE
O-Ring:	NBR	O-ring:	NBR
Zugentlastung:	Ausführung A nach EN 62444	Strain relief:	Version A acc. to EN 62444
Schutzart:	IP 68 (bis 10 bar) / IP 69	Protection class:	IP 68 (up to 10 bar) / IP 69
NEMA Type rating:	4X	NEMA Type rating:	4X
Eigenschaften:	Sehr guter Schirmkontakt über die Kontakthülse bei in der Kabelverschraubung endendem Schirmgeflecht	Properties:	Excellent shield contact through the contact sleeve with the braided shield terminating in the screwed cable gland
Einsatztemperatur:	-40 °C / +100 °C	Operation temperature:	-40 °C / +100 °C

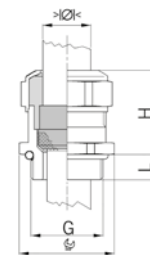

Einteiliger Dichteinsatz Nicht durchgehend isolierend		One-piece sealing insert not overall length insulated						
G	>math>10</math> min mm	>math>10</math> max mm	mm	H mm	L mm	i info	Art.-No.	
M8x1.25	2.5	3.5	11	15	10	1	1180.08.035	50
M8x1.25	3.0	4.0	11	15	10	1	1180.08.040	50
M10x1.5	3.0	4.0	13	16	10	1	1180.10.040	50
M10x1.5	4.0	6.0	13	16	10	1	1180.10.060	50
M12x1.5	4.5	6.0	15	20	10	-	1180.12.060	50
M12x1.5	6.0	7.5	15	20	10	-	1180.12.075	50
M16x1.5	6.0	8.0	18	23	10	-	1180.17.080	50
M16x1.5	8.0	10.0	18	25	10	-	1180.17.100	50
M20x1.5	8.0	11.0	24	25	10	-	1180.20.110	50
M20x1.5	11.0	14.0	24	27	10	-	1180.20.140	50
M25x1.5	13.0	16.0	30	30	11	-	1180.25.160	25
M25x1.5	16.0	19.0	30	33	11	-	1180.25.190	25
M32x1.5	18.0	21.0	36	32	13	-	1180.32.210	25
M32x1.5	21.0	25.0	36	32	13	-	1180.32.250	25
M40x1.5	24.0	28.5	46	34	13	-	1180.40.285	10
M40x1.5	28.5	32.0	46	34	13	-	1180.40.320	10
M50x1.5	33.0	37.0	55	36	14	-	1180.50.370	10
M50x1.5	37.0	41.0	55	36	14	-	1180.50.410	10
M63x1.5	40.0	46.0	70	39	14	-	1180.63.460	5
M63x1.5	46.0	50.0	70	39	14	-	1180.63.500	5

1 = Metrisches Regelgewinde (mit VDE Testreport)      1 = Metric coarse-pitch thread (with VDE test report)

Erhältlich mit Dichteinsatz gemäss EN 45545 / NFPA 130. Available with sealing inserts conformity with EN 45545 / NFPA 130. When placing an inquiry, prefix the article number by the capital F.



Progress MS EMV



# Kabelverschraubungen Progress® EMV Messing mit Kontakthülse

## Cable glands Progress® EMC nickel-plated brass with contact sleeve

### Kurzes Anschlussgewinde Pg | Short entry thread Pg

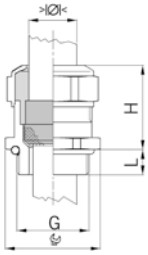

Material: Messing vernickelt  
 Kontakthülse: Messing vernickelt  
 Dichtung: TPE  
 O-Ring: NBR  
 Schutzart: IP 68 (bis 10 bar) / IP 69  
 NEMA Type rating: 4X  
 Eigenschaften: Sehr guter Schirmkontakt über die Kontakthülse bei in der Kabelverschraubung endendem Schirmgeflecht

Material: Nickel-plated brass  
 Contact sleeve: Nickel-plated brass  
 Seal: TPE  
 O-ring: NBR  
 Protection class: IP 68 (up to 10 bar) / IP 69  
 NEMA Type rating: 4X  
 Properties: Excellent shield contact through the contact sleeve with the braided shield terminating in the screwed cable gland  
 Operation temperature: -40 °C / +100 °C

Einsatztemperatur: -40 °C / +100 °C

Operation temperature: -40 °C / +100 °C



Progress MS EMV



Einteiliger Dichteinsatz  
 Nicht durchgehend isolierend

One-piece sealing insert  
 not overall length insulated

G	>math>D_1</math> min mm	>math>D_2</math> max mm	 mm	H mm	L mm	Art.-No.	
Pg 7	4.5	6.0	15	20	6	1080.07.060	50
Pg 7	6.0	7.5	15	20	6	1080.07.075	50
Pg 9	6.0	8.0	18	23	6	1080.09.080	50
Pg 9	8.0	10.0	18	25	6	1080.09.100	50
Pg 11	5.5	8.5	21	23	6	1080.11.085	50
Pg 11	8.5	12.0	21	23	6	1080.11.120	50
Pg 13	8.0	11.0	24	25	6	1080.13.110	50
Pg 13	11.0	14.0	24	27	6	1080.13.140	50
Pg 16	8.0	11.0	24	24	6	1080.16.110	50
Pg 16	11.0	14.0	24	27	6	1080.16.140	50
Pg 21	13.0	16.0	30	30	7.5	1080.21.160	25
Pg 21	16.0	19.0	30	33	7.5	1080.21.190	25
Pg 29	19.0	23.0	38	33	8	1080.29.230	25
Pg 29	23.0	25.5	38	32	8	1080.29.255	25
Pg 36	25.0	30.5	50	36	8	1080.36.305	10
Pg 36	30.5	35.0	50	34	8	1080.36.350	10
Pg 42	33.0	37.0	55	37	10	1080.42.370	10
Pg 42	37.0	41.0	55	36	10	1080.42.410	10
Pg 48	39.0	43.0	65	42	11	1080.48.430	10
Pg 48	43.0	46.5	65	40	11	1080.48.465	10

Erhältlich mit Dichteinsatz gemäss EN 45545 / NFPA 130.  
 Bei Anfragen oder Bestellung bitte ein F vor die Artikelnummer setzen.

Available with sealing inserts conformity with EN 45545 / NFPA 130. When placing an inquiry, prefix the article number by the capital F.

# Kabelverschraubungen Progress® EMV Messing mit Kontakthülse

## Cable glands Progress® EMC nickel-plated brass with contact sleeve

### Langes Anschlussgewinde Pg | Long entry thread Pg

Material:	Messing vernickelt	Material:	Nickel-plated brass
Kontakthülse:	Messing vernickelt	Contact sleeve:	Nickel-plated brass
Dichtung:	TPE	Seal:	TPE
O-Ring:	NBR	O-ring:	NBR
Schutzart:	IP 68 (bis 10 bar) / IP 69	Protection class:	IP 68 (up to 10 bar) / IP 69
NEMA Type rating:	4X	NEMA Type rating:	4X
Eigenschaften:	Sehr guter Schirmkontakt über die Kontakthülse bei in der Kabelverschraubung endendem Schirmgeflecht	Properties:	Excellent shield contact through the contact sleeve with the braided shield terminating in the screwed cable gland
Einsatztemperatur:	-40 °C / +100 °C	Operation temperature:	-40 °C / +100 °C

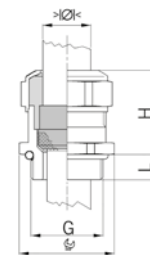

Einteiliger Dichteinsatz  
Nicht durchgehend isolierend

One-piece sealing insert  
not overall length insulated

G	>12< min mm	>12< max mm	H mm	L mm	Art.-No.	
Pg 7	4.5	6.0	15	20	1180.07.060	50
Pg 7	6.0	7.5	15	20	1180.07.075	50
Pg 9	6.0	8.0	18	23	1180.09.080	50
Pg 9	8.0	10.0	18	25	1180.09.100	50
Pg 11	5.5	8.5	21	23	1180.11.085	50
Pg 11	8.5	12.0	21	23	1180.11.120	50
Pg 13	8.0	11.0	24	25	1180.13.110	50
Pg 13	11.0	14.0	24	27	1180.13.140	50
Pg 16	8.0	11.0	24	24	1180.16.110	50
Pg 16	11.0	14.0	24	27	1180.16.140	50
Pg 21	13.0	16.0	30	30	1180.21.160	25
Pg 21	16.0	19.0	30	33	1180.21.190	25
Pg 29	19.0	23.0	38	33	1180.29.230	25
Pg 29	23.0	25.5	38	32	1180.29.255	25
Pg 36	25.0	30.5	50	36	1180.36.305	10
Pg 36	30.5	35.0	50	34	1180.36.350	10
Pg 42	33.0	-	55	37	1180.42.370	10
Pg 42	37.0	41.0	55	36	1180.42.410	10
Pg 48	39.0	43.0	65	42	1180.48.430	10
Pg 48	43.0	46.5	65	40	1180.48.465	10

Erhältlich mit Dichteinsatz gemäss EN 45545 / NFPA 130. Available with sealing inserts conformity with EN 45545 / NFPA 130. When placing an inquiry, prefix the article number by the capital F.



Progress MS EMV



**Kurzes Anschlussgewinde metrisch | Short entry thread metric**

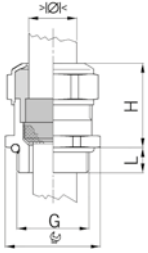

Material: Messing vernickelt  
 Kontakthülse: Messing vernickelt  
 Dichtung: FPM  
 O-Ring: FPM  
 Zugentlastung: Ausführung A nach EN 62444  
 Schutzart: IP 68 (bis 10 bar) / IP 69  
 Eigenschaften: Sehr guter Schirmkontakt über die Kontakthülse bei in der Kabelverschraubung endendem Schirmgeflecht  
 Einsatztemperatur: -40 °C / +200 °C

Material: Nickel-plated brass  
 Contact sleeve: Nickel-plated brass  
 Seal: FPM  
 O-ring: FPM  
 Strain relief: Version A acc. to EN 62444  
 Protection class: IP 68 (up to 10 bar) / IP 69  
 Properties: Excellent shield contact through the contact sleeve with the braided shield terminating in the screwed cable gland  
 Operation temperature: -40 °C / +200 °C



Einteiliger Dichteinsatz  
 Nicht durchgehend isolierend

One-piece sealing insert  
 not overall length insulated

G	> Ø <	> Ø <	mm	H	L	i	Art.-No.	
	min mm	max mm	mm	mm	mm	info		
M10x1.5	3.0	4.0	13	16	5	1	1080.10.91.040	50
M10x1.5	4.0	6.0	13	16	5	1	1080.10.91.060	50
M12x1.5	4.5	6.0	15	20	5	-	1080.12.91.060	50
M12x1.5	6.0	7.5	15	20	5	-	1080.12.91.075	50
M16x1.5	6.0	8.0	18	23	5	-	1080.17.91.080	50
M16x1.5	8.0	10.0	18	25	5	-	1080.17.91.100	50
M20x1.5	8.0	11.0	24	25	6	-	1080.20.91.110	50
M20x1.5	11.0	14.0	24	27	6	-	1080.20.91.140	50
M25x1.5	13.0	16.0	30	30	7	-	1080.25.91.160	25
M25x1.5	16.0	19.0	30	33	7	-	1080.25.91.190	25
M32x1.5	18.0	21.0	36	32	8	-	1080.32.91.210	25
M32x1.5	21.0	25.0	36	32	8	-	1080.32.91.250	25

1 = Metrisches Regelgewinde

1 = Metric coarse-pitch thread

**Langes Anschlussgewinde metrisch | Long entry thread metric**



Einteiliger Dichteinsatz  
 Nicht durchgehend isolierend

One-piece sealing insert  
 not overall length insulated

G	> Ø <	> Ø <	mm	H	L	i	Art.-No.	
	min mm	max mm	mm	mm	mm	info		
M10x1.5	3.0	4.0	13	16	10	1	1180.10.91.040	50
M10x1.5	4.0	6.0	13	16	10	1	1180.10.91.060	50
M12x1.5	4.5	6.0	15	20	10	-	1180.12.91.060	50
M12x1.5	6.0	7.5	15	20	10	-	1180.12.91.075	50
M16x1.5	6.0	8.0	18	23	10	-	1180.17.91.080	50
M16x1.5	8.0	10.0	18	25	10	-	1180.17.91.100	50
M20x1.5	8.0	11.0	24	25	10	-	1180.20.91.110	50
M20x1.5	11.0	14.0	24	27	10	-	1180.20.91.140	50
M25x1.5	13.0	16.0	30	30	11	-	1180.25.91.160	25
M25x1.5	16.0	19.0	30	33	11	-	1180.25.91.190	25
M32x1.5	18.0	21.0	36	32	13	-	1180.32.91.210	25
M32x1.5	21.0	25.0	36	32	13	-	1180.32.91.250	25

1 = Metrisches Regelgewinde

1 = Metric coarse-pitch thread

**Kurzes Anschlussgewinde Pg | Short entry thread Pg**

Material:	Messing vernickelt	Material:	Nickel-plated brass
Kontakthülse:	Messing vernickelt	Contact sleeve:	Nickel-plated brass
Dichtung:	FPM	Seal:	FPM
O-Ring:	FPM	O-ring:	FPM
Schutzart:	IP 68 (bis 10 bar) / IP 69	Protection class:	IP 68 (up to 10 bar) / IP 69
Eigenschaften:	Sehr guter Schirmkontakt über die Kontakthülse bei in der Kabelverschraubung endendem Schirmgeflecht	Properties:	Excellent shield contact through the contact sleeve with the braided shield terminating in the screwed cable gland
Einsatztemperatur:	-40 °C / +200 °C	Operation temperature:	-40 °C / +200 °C

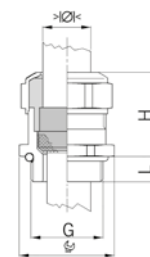

Einteiliger Dichteinsatz  
 Nicht durchgehend isolierend

One-piece sealing insert  
 not overall length insulated

G	$\gt;\varnothing<$ min mm	$\gt;\varnothing<$ max mm	 mm	H mm	L mm	Art.-No.	
Pg 9	6.0	8.0	18	23	6	1080.09.91.080	50
Pg 9	8.0	10.0	18	25	6	1080.09.91.100	50
Pg 11	5.5	8.5	21	23	6	1080.11.91.085	50
Pg 11	8.5	12.0	21	23	6	1080.11.91.120	50
Pg 13	8.0	11.0	24	25	6	1080.13.91.110	50
Pg 13	11.0	14.0	24	27	6	1080.13.91.140	50
Pg 16	8.0	11.0	24	24	6	1080.16.91.110	50
Pg 16	11.0	14.0	24	27	6	1080.16.91.140	50
Pg 21	13.0	16.0	30	30	7.5	1080.21.91.160	25
Pg 21	16.0	19.0	30	33	7.5	1080.21.91.190	25
Pg 29	19.0	23.0	38	33	8	1080.29.91.230	25
Pg 29	23.0	25.5	38	32	8	1080.29.91.255	25



**Langes Anschlussgewinde Pg | Long entry thread Pg**

Einteiliger Dichteinsatz  
 Nicht durchgehend isolierend

One-piece sealing insert  
 not overall length insulated

G	$\gt;\varnothing<$ min mm	$\gt;\varnothing<$ max mm	 mm	H mm	L mm	Art.-No.	
Pg 9	6.0	8.0	18	23	10	1180.09.91.080	50
Pg 9	8.0	10.0	18	25	10	1180.09.91.100	50
Pg 11	5.5	8.5	21	23	10	1180.11.91.085	50
Pg 11	8.5	12.0	21	23	10	1180.11.91.120	50
Pg 13	8.0	11.0	24	25	10	1180.13.91.110	50
Pg 13	8.5	12.0	24	27	10	1180.13.91.140	50
Pg 16	8.0	11.0	24	24	10	1180.16.91.110	50
Pg 16	11.0	14.0	24	27	10	1180.16.91.140	50
Pg 21	13.0	16.0	30	30	12	1180.21.91.160	25
Pg 21	16.0	19.0	30	33	12	1180.21.91.190	25
Pg 29	19.0	23.0	38	33	12	1180.29.91.230	25
Pg 29	23.0	25.5	38	32	12	1180.29.91.255	25



# Kabelverschraubungen Progress® EMV Messing mit Knickschutzfeder

## Cable glands Progress® EMC nickel-plated brass with antikink spring

### Kurzes Anschlussgewinde metrisch | Short entry thread metric

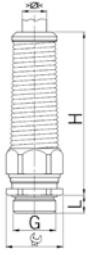

Material: Messing vernickelt  
 Knickschutzfeder: Rostfreier Stahl A2  
 Dichtung: TPE  
 O-Ring: NBR  
 Zugentlastung: Ausführung A nach EN 62444  
 Schutzart: IP 68 (bis 10 bar) / IP 69  
 Eigenschaften: Sehr guter Schirmkontakt über die Kontakthülse bei in der Kabelverschraubung endendem Schirmgeflecht  
 Einsatztemperatur: -40 °C / +100 °C

Material: Nickel-plated brass  
 Antikink spring: Stainless steel A2  
 Seal: TPE  
 O-ring: NBR  
 Strain relief: Version A acc. to EN 62444  
 Protection class: IP 68 (up to 10 bar) / IP 69  
 Properties: Excellent shield contact through the contact sleeve with the braided shield terminating in the screwed cable gland  
 Operation temperature: -40 °C / +100 °C



Einteiliger Dichteinsatz  
 Nicht durchgehend isolierend

One-piece sealing insert  
 not overall length insulated

G	> Ø <	> Ø <	Ø	H	L	i	Art.-No.	
	min mm	max mm	mm	mm	mm	info		
M8x1.25	2.5	3.5	11	50	5	1	1080.08.52.035	10
M8x1.25	3.0	4.0	11	50	5	1	1080.08.52.040	10
M10x1.5	3.0	4.0	13	54	5	1	1080.10.52.040	10
M10x1.5	4.0	6.0	13	54	5	1	1080.10.52.060	10
M12x1.5	4.5	6.0	15	60	5	-	1080.12.52.060	10
M12x1.5	6.0	7.5	15	60	5	-	1080.12.52.075	10
M16x1.5	6.0	8.0	18	69	5	-	1080.17.52.080	10
M16x1.5	8.0	10.0	18	69	5	-	1080.17.52.100	10
M20x1.5	8.0	11.0	24	88	6	-	1080.20.52.110	10
M20x1.5	11.0	14.0	24	88	6	-	1080.20.52.140	10
M25x1.5	13.0	16.0	30	104	7	-	1080.25.52.160	10
M25x1.5	16.0	19.0	30	104	7	-	1080.25.52.190	10
M32x1.5	18.0	21.0	36	112	8	-	1080.32.52.210	5
M32x1.5	21.0	24.5	36	112	8	-	1080.32.52.245	5

1 = Metrisches Regelgewinde (mit VDE Testreport)

1 = Metric coarse-pitch thread (with VDE test report)

Erhältlich mit Dichteinsatz gemäss EN 45545 / NFPA 130. Bei Anfragen oder Bestellung bitte ein F vor die Artikelnummer setzen.

Available with sealing inserts conformity with EN 45545 / NFPA 130. When placing an inquiry, prefix the article number by the capital F.

Auf Anfrage lieferbar:

Available on request:

Langes Anschlussgewinde

Long entry thread

Progress MS EMV FKN



# Kabelverschraubungen Progress® EMV Messing mit Knickschutzfeder Cable glands Progress® EMC nickel-plated brass with antikink spring

## Kurzes Anschlussgewinde Pg | Short entry thread Pg

Material:	Messing vernickelt	Material:	Nickel-plated brass
Knickschutzfeder:	Rostfreier Stahl A2	Antikink spring:	Stainless steel A2
Dichtung:	TPE	Seal:	TPE
O-Ring:	NBR	O-ring:	NBR
Schutzart:	IP 68 (bis 10 bar) / IP 69	Protection class:	IP 68 (up to 10 bar) / IP 69
Eigenschaften:	Sehr guter Schirmkontakt über die Kontakthülse bei in der Kabelverschraubung endendem Schirmgeflecht	Properties:	Excellent shield contact through the contact sleeve with the braided shield terminating in the screwed cable gland
Einsatztemperatur:	-40 °C / +100 °C	Operation temperature:	-40 °C / +100 °C

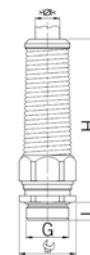

Einteiliger Dichteinsatz Nicht durchgehend isolierend				One-piece sealing insert not overall length insulated			
G	min mm	max mm	mm	H mm	L mm	Art.-No.	
<b>Pg 7</b>	4.5	6.0	15	60	6	<b>1080.07.52.060</b>	10
<b>Pg 7</b>	6.0	7.5	15	60	6	<b>1080.07.52.075</b>	10
<b>Pg 9</b>	6.0	8.0	18	69	6	<b>1080.09.52.080</b>	10
<b>Pg 9</b>	8.0	10.0	18	69	6	<b>1080.09.52.100</b>	10
<b>Pg 11</b>	6.0	8.0	18/21	69	6	<b>1080.11.52.080</b>	10
<b>Pg 11</b>	8.0	10.0	18/21	69	6	<b>1080.11.52.100</b>	10
<b>Pg 13</b>	8.0	11.0	24	88	6	<b>1080.13.52.110</b>	10
<b>Pg 13</b>	11.0	14.0	24	88	6	<b>1080.13.52.140</b>	10
<b>Pg 16</b>	8.0	11.0	24	88	6	<b>1080.16.52.110</b>	10
<b>Pg 16</b>	11.0	14.0	24	88	6	<b>1080.16.52.140</b>	10
<b>Pg 21</b>	13.0	16.0	30	104	7	<b>1080.21.52.160</b>	5
<b>Pg 21</b>	16.0	19.0	30	104	7	<b>1080.21.52.190</b>	5

Erhältlich mit Dichteinsatz gemäss EN 45545 / NFPA 130. Bei Anfragen oder Bestellung bitte ein F vor die Artikelnummer setzen.

Auf Anfrage lieferbar:  
Langes Anschlussgewinde

Available with sealing inserts conformity with EN 45545 / NFPA 130. When placing an inquiry, prefix the article number by the capital F.

Available on request:  
Long entry thread



# Kabelverschraubungen Progress® EMV powerCONNECT Messing Cable glands Progress® EMC powerCONNECT nickel-plated brass

## Kurzes Anschlussgewinde metrisch | Short entry thread metric

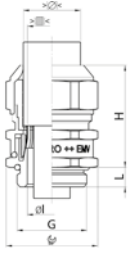

Material: Messing vernickelt  
 Dichtung: TPE  
 O-Ring: NBR  
 Zugentlastung: Ausführung A nach EN 62444  
 Schutzart: IP 68 (bis 10 bar) / IP 69  
 NEMA Type rating: 4X  
 Eigenschaften: Für hohe Ableitströme, konzentrische Schirmkontaktierung 360° mit tiefstem Übergangswiderstand und Transferimpedanz. Sehr geringe Bauhöhe.  
 Einsatztemperatur: -60 °C / +100 °C

Material: Nickel-plated brass  
 Seal: TPE  
 O-ring: NBR  
 Strain relief: Version A acc. to EN 62444  
 Protection class: IP 68 (up to 10 bar) / IP 69  
 NEMA Type rating: 4X  
 Properties: For high leakage currents, concentric 360° shield contact ensure extremely low transfer resistance and transfer impedance. Compact design  
 Operation temperature: -60 °C / +100 °C



Progress  
EMV powerCONNECT



Zweiteiliger Dichteinsatz  
Nicht durchgehend isolierend

G	> Ø < min mm	> Ø < max mm	> Ø < min mm	> Ø < max mm	> ■ < mm	Ø mm	⌀ mm	H mm	L mm	i info	Art.-No.	
M16x1.5	6.0	8.0	8.0	10.5	9.3	8.2	18	28	5	-	1084.17	25
M20x1.5	8.0	11.0	11.0	15.0	13.4	11.9	24	32	6	-	1084.20	25
M25x1.5	12.5	16.0	16.0	20.5	18.7	17.6	30	36.5	7	-	1084.25	25
M32x1.5	17.0	21.0	21.0	25.5	23.8	22.1	36	38.5	8	-	1084.32	25
M40x1.5	24.0	28.5	28.5	33.0	30.4	29.5	46	42	8	-	1084.40	10
M50x1.5	33.0	37.0	37.0	42.0	38.7	37.7	55	44.5	9	-	1084.50	10
M63x1.5	40.0	46.0	46.0	52.0	48.6	46.6	70	49	10	-	1084.63	5
M75x1.5	50.0	56.0	56.0	63.0	59.7	57.9	80	51	11	-	1084.75	1
M80x2.0	-	-	58.0	65.0	62.0	59.8	95	58	12	1	1084.80.650	1
M85x2.0	-	-	63.0	70.0	67.0	64.7	95	58	12	1	1084.85.700	1

Two-piece sealing insert  
not overall length insulated

1 = Einteiliger Dichteinsatz

1 = One-piece sealing insert

Erhältlich mit Dichteinsatz gemäss EN 45545 / NFPA 130. Bei Anfragen oder Bestellung bitte ein F vor die Artikelnummer setzen.

Available with sealing inserts conformity with EN 45545 / NFPA 130. When placing an inquiry, prefix the article number by the capital F.

Auf Anfrage lieferbar:

Available on request:

Rostfreier Stahl A2 oder A4

Stainless steel A2 or A4

Anschlussgewinde Pg und NPT

Entry thread Pg and NPT

## Langes Anschlussgewinde metrisch | Long entry thread metric



Progress  
EMV powerCONNECT



Zweiteiliger Dichteinsatz  
Nicht durchgehend isolierend

G	> Ø < min mm	> Ø < max mm	> Ø < min mm	> Ø < max mm	> ■ < mm	Ø mm	⌀ mm	H mm	L mm	i info	Art.-No.	
M16x1.5	6.0	8.0	8.0	10.5	9.3	8.2	18	28	10	-	1184.17	25
M20x1.5	8.0	11.0	11.0	15.0	13.4	11.9	24	32	10	-	1184.20	25
M25x1.5	12.5	16.0	16.0	20.5	18.7	17.6	30	36.5	11	-	1184.25	25
M32x1.5	17.0	21.0	21.0	25.5	23.8	22.1	36	38.5	13	-	1184.32	25
M40x1.5	24.0	28.5	28.5	33.0	30.4	29.5	46	42	13	-	1184.40	10
M50x1.5	33.0	37.0	37.0	42.0	38.7	37.7	55	44.5	14	-	1184.50	10
M63x1.5	40.0	46.0	46.0	52.0	48.6	46.6	70	49	14	-	1184.63	5
M75x1.5	50.0	56.0	56.0	63.0	59.7	57.9	80	51	15	-	1184.75	1
M80x2.0	-	-	58.0	65.0	62.0	59.8	95	58	18	1	1184.80.650	1
M85x2.0	-	-	63.0	70.0	67.0	64.7	95	58	18	1	1184.85.700	1

Two-piece sealing insert  
not overall length insulated

1 = Einteiliger Dichteinsatz

1 = One-piece sealing insert

Erhältlich mit Dichteinsatz gemäss EN 45545 / NFPA 130. Bei Anfragen oder Bestellung bitte ein F vor die Artikelnummer setzen.

Available with sealing inserts conformity with EN 45545 / NFPA 130. When placing an inquiry, prefix the article number by the capital F.

Auf Anfrage lieferbar:

Available on request:

Rostfreier Stahl A2 oder A4

Stainless steel A2 or A4

Anschlussgewinde Pg und NPT

Entry thread Pg and NPT

# Kabelverschraubungen Progress® EMV Serie 85 Messing mit Spannzange Cable glands Progress® EMC Series 85 nickel-plated brass with collet chuck

## Anschlussgewinde metrisch | Entry thread metric

Material:	Messing vernickelt	Material:	Nickel-plated brass
Dichtung:	TPE	Seal:	TPE
O-Ring:	NBR	O-ring:	NBR
Zugentlastung:	Ausführung A nach EN 62444	Strain relief:	Version A acc. to EN 62444
Schutzart:	IP 68 (bis 10 bar) / IP 69	Protection class:	IP 68 (up to 10 bar) / IP 69
Eigenschaften:	Für hohe Ableitströme, konzentrische Schirmkontaktierung mit tiefsten Übergangswiderständen und Transferimpedanzen	Properties:	For high leakage currents, concentric shield contact with minimal transfer resistances and transfer impedances
Einsatztemperatur:	-40 °C / +100 °C	Operation temperature:	-40 °C / +100 °C

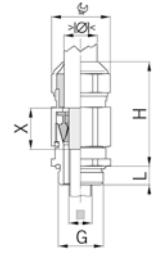

Zweiteiliger Dichteinsatz  
Nicht durchgehend isolierend

Two-piece sealing insert  
not overall length insulated

G	>∅< min mm	>∅< max mm	>∅< min mm	>∅< max mm	>■< mm	H mm	L mm	X mm	Art.-No.	
M16x1.5	-	-	4.5	6.0	3.0-4.5	18	40	6	1000.17.85.045	25
M16x1.5	6.0	8.0	8.0	10.5	4.5-8.0	18	42	8	1000.17.85.080	25
M16x1.5	8.0	11.0	11.0	15.0	7.5-10.0	24	47	8	1000.17.85.100	25
M20x1.5	8.0	11.0	11.0	15.0	7.5-12.0	24	47	8	1000.20.85.120	25
M20x1.5	12.5	16.0	16.0	20.5	10.0-14.0	30	59	8	1000.20.85.140	20
M25x1.5	12.5	16.0	16.0	20.5	10.0-16.0	30	59	8	1000.25.85.160	20
M25x1.5	17.0	21.0	21.0	25.5	14.0-19.0	36	66	8	1000.25.85.190	25
M32x1.5	17.0	21.0	21.0	25.5	14.0-22.0	36	66	10	1000.32.85.220	25
M32x1.5	24.0	28.5	28.5	33.0	21.0-25.0	46	68	10	1000.32.85.250	5
M40x1.5	24.0	28.5	28.5	33.0	21.0-30.0	46	68	12	1000.40.85.300	5
M50x1.5	33.0	37.0	37.0	42.0	29.0-38.0	55	82	13	1000.50.85.380	5
M63x1.5	33.0	37.0	37.0	42.0	29.0-38.0	70/55	82	15	1000.63.85.380	5
M63x1.5	40.0	46.0	46.0	52.0	35.0-44.0	70	78	15	1000.63.85.440	1



Progress EMV Serie 85



Erhältlich mit Dichteinsatz gemäß EN 45545 / NFPA 130. Bei Anfragen oder Bestellung bitte ein F vor die Artikelnummer setzen.

Available with sealing inserts conformity with EN 45545 / NFPA 130. When placing an inquiry, prefix the article number by the capital F.

Wichtig: Um den Kabelschirm und die Kabellitzen optimal zu schützen ist es erforderlich, das der Kabelverschraubung beiliegende Kupfer-EMV-Tape zu montieren.

Important: To provide the best possible protection for the cable shield and the cable, it is necessary to install a copper EMC tape.

Das Kupfer-Tape muss zwingend gemäßss Illustration montiert werden!  
(Beispiel: Tape Scotch 3M Typ 1181)

The copper tape must be fixed according to the illustration!  
(Example: Tape Scotch 3M Typ 1181)



# Kabelverschraubungen Progress® EMV Serie 85 Messing mit Spannzange Cable glands Progress® EMC Series 85 nickel-plated brass with collet chuck

## Anschlussgewinde Pg | Entry thread Pg

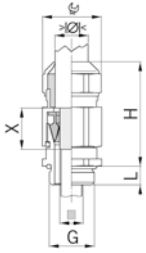

Material: Messing vernickelt  
 Dichtung: TPE  
 O-Ring: NBR  
 Schutzart: IP 68 (bis 10 bar) / IP 69  
 Eigenschaften: Für hohe Ableitströme, konzentrische Schirmkontaktierung mit tiefsten Übergangswiderständen und Transferimpedanzen  
 Einsatztemperatur: -40 °C / +100 °C

Material: Nickel-plated brass  
 Seal: TPE  
 O-ring: NBR  
 Protection class: IP 68 (up to 10 bar) / IP 69  
 Properties: For high leakage currents, concentric shield contact with minimal transfer resistances and transfer impedances  
 Operation temperature: -40 °C / +100 °C



Zweiteiliger Dichteinsatz  
 Nicht durchgehend isolierend

Two-piece sealing insert  
 not overall length insulated

G	> ◊ < min mm	> ◊ < max mm	> ◊ < min mm	> ◊ < max mm	>■ < mm	mm	H mm	L mm	X mm	Art.-No.	
Pg 11	6.0	8.0	8.0	10.5	4.5-8.0	21/18	42	8	16	1000.11.85.080	25
Pg 11	8.0	11.0	11.0	15.0	7.5-12.0	24	47	8	20	1000.11.85.120	25
Pg 16	8.0	11.0	11.0	15.0	7.5-12.0	24	47	8	20	1000.16.85.120	25
Pg 16	12.5	16.0	16.0	20.5	10.0-15.0	30	59	8	21	1000.16.85.150	25
Pg 16	12.5	16.0	16.0	20.5	10.0-16.0	30	59	8	21	1000.21.85.160	20
Pg 21	17.0	21.0	21.0	25.5	14.0-19.0	36	66	8	24	1000.21.85.190	25
Pg 29	17.0	21.0	21.0	25.5	14.0-22.0	38/36	66	10	24	1000.29.85.220	20
Pg 29	24.0	28.5	28.5	33.0	21.0-25.0	46	68	10	24	1000.29.85.250	5

Erhältlich mit Dichteinsatz gemäss EN 45545 / NFPA 130.  
 Bei Anfragen oder Bestellung bitte ein F vor die Artikelnummer setzen.

Available with sealing inserts conformity with EN 45545 / NFPA 130. When placing an inquiry, prefix the article number by the capital F.

Wichtig: Um den Kabelschirm und die Kabellitzen optimal zu schützen ist es erforderlich, das der Kabelverschraubung beiliegende Kupfer-EMV-Tape zu montieren.

Important: To provide the best possible protection for the cable shield and the cable, it is necessary to install a copper EMC tape.

Weitere Abmessungen auf Anfrage

Further dimensions upon request

Das Kupfer-Tape muss zwingend gemäss Illustration montiert werden!  
 (Beispiel: Tape Scotch 3M Typ 1181)

The copper tape must be fixed according to the illustration!  
 (Example: Tape Scotch 3M Typ 1181)

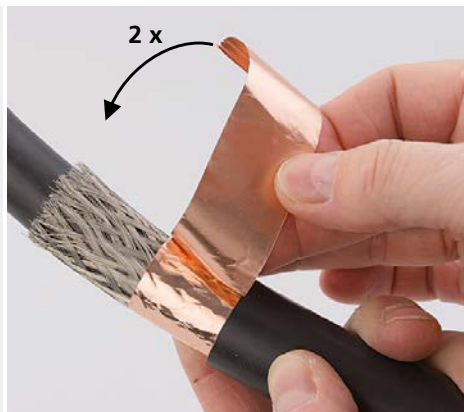

# EMV-Gegenmutter Messing mit Schneidezähnen

## EMC lock nuts nickel-plated brass with cutter teeth

### Anschlussgewinde metrisch | Entry thread metric

Material: Messing vernickelt  
 Ausführung: EMV-Gegenmutter mit Schneidezähnen für eine optimale Kontaktierung  
 Einsatztemperatur: -60 °C / +200 °C

Material: Nickel-plated brass  
 Execution: EMC lock nut with cutting teeth for optimised shield contact  
 Operation temperature: -60 °C / +200 °C

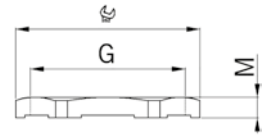

G	 mm	M	i	Art.-No.	
M8x1.25	11	3.3	1	8008.85	25
M10x1.5	13	3.3	1	8010.85	25
M12x1.5	15	3.5	-	8012.85	25
M16x1.5	19	3.5	-	8017.85	25
M20x1.5	24	4.0	-	8020.85	25
M25x1.5	30	4.0	-	8025.85	10
M32x1.5	36	5.0	-	8032.85	10
M40x1.5	46	5.3	-	8040.85	10
M50x1.5	55	6.3	-	8050.85	10
M63x1.5	70	7.0	-	8063.85	10
M75x1.5	80	8.0	-	8075.85	5
M80x2.0	95	9.0	-	8080.85	5
M85x2.0	95	9.0	-	8085.85	5

1 = Metrisches Regelgewinde      1 = Metric coarse-pitch thread

### Anschlussgewinde Pg | Entry thread Pg

G	 mm	M	Art.-No.	
Pg 7	15	3.3	8007.85	25
Pg 9	18	3.3	8009.85	25
Pg 11	21	3.5	8011.85	25
Pg 13	24	3.5	8013.85	25
Pg 16	26	3.5	8016.85	25
Pg 21	32	4.0	8021.85	10
Pg 29	41	4.6	8029.85	10
Pg 36	50	5.8	8036.85	10
Pg 42	60	5.8	8042.85	10
Pg 48	65	6.5	8048.85	10



# Erdungslaschen zu Kabelverschraubungen

## Grounding straps suitable for cable glands

passend zu Kabelverschraubungen Progress® | suitable for cable glands Progress®

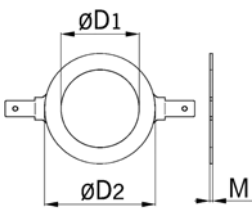

Material: Messing roh  
 Einsatzbereich: Löt- oder steckbar  
 6,3 x 1,0 mm  
 Einsatztemperatur: -60 °C / +200 °C

Material: Brass raw  
 Application: Solderable or pluggable  
 6,3 x 1,0 mm  
 Operation temperature: -60 °C / +200 °C



Erdungslaschen zu Kabelverschraubungen  
 Anschlussgewinde metrisch

Grounding straps suitable for cable glands  
 Entry thread metric

G	ØD1 mm	ØD2 mm	M mm	Art.-No.	
M12 / Pg 7	13.0	24	1	1007.80.10	100
M16 / Pg 9	16.5	24	1	1017.80.10	100
M20 / Pg 13	20.7	28	1	1020.80.10	100
M25	25.5	32	1	1025.80.10	100
M32	33.0	40	1	1032.80.10	100
M40	40.5	52	1	1040.80.10	100
M50	50.5	62	1	1050.80.10	100
M63	63.5	78	1	1063.80.10	50



Erdungslaschen zu Kabelverschraubungen  
 Anschlussgewinde Pg

Grounding straps suitable for cable glands  
 Entry thread Pg

G	ØD1 mm	ØD2 mm	M mm	Art.-No.	
M12 / Pg 7	13.0	24	1	1007.80.10	100
M16 / Pg 9	16.5	24	1	1017.80.10	100
Pg 11	19.0	28	1	1011.80.10	100
M20 / Pg 13	20.7	28	1	1020.80.10	100
Pg 16	23.0	32	1	1016.80.10	100
Pg 21	29.0	37	1	1021.80.10	100
Pg 29	38.0	52	1	1029.80.10	100
Pg 36	48.0	62	1	1036.80.10	100



Evolution EMC SETALL R1  
Evolution EMC SEATALL R1



116 - 117

Evolution EMC Komponenten  
Evolution EMC components



118 - 121

Evolution EMC Werkzeug  
Evolution EMC tool



122 - 124

1

2

3

4

5

6

7

8

9

10

11

12

13

14

15



# EVolution EMC Kabelverschraubungen

## EVolution EMC cable glands

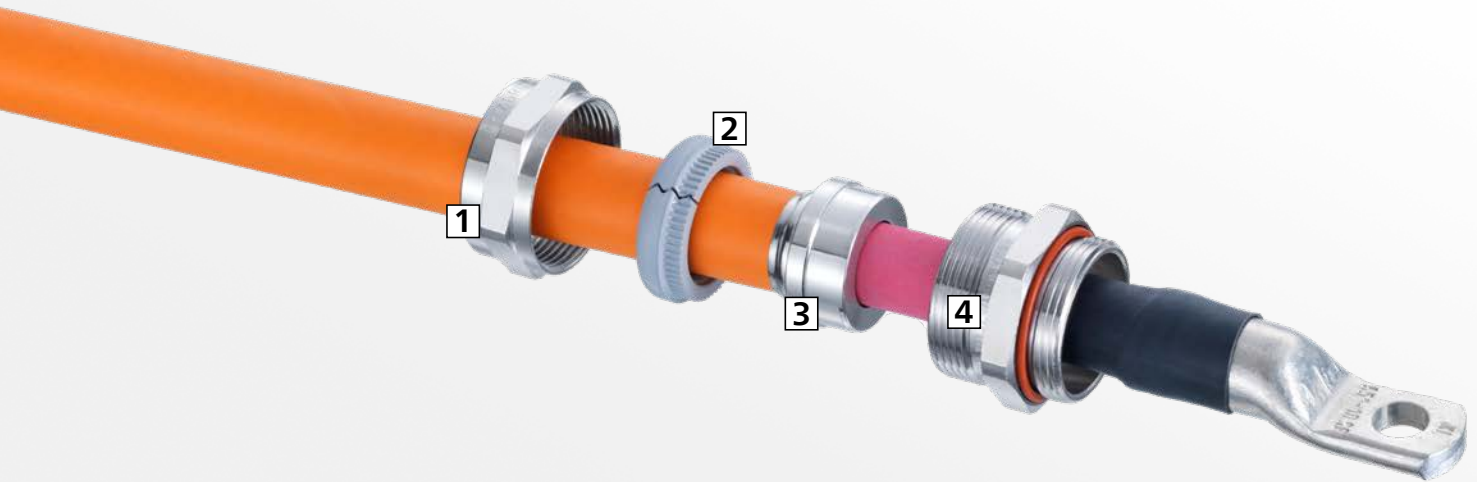

Die **EVolution EMC** Kabelverschraubung gewährleistet eine prozesssichere und langlebige Schirmanbindung von geschirmten Kabeln im Bereich der Elektromobilität. Die neue Konstruktion erlaubt das mehrmalige Stecken des Schirmkontaktes im Unterteil und ermöglicht so die Vorkonfektionierung der Kabel. Vorkonfektionierte Kabelbäume senken die Montagekosten, vereinfachen die Fertigungsabläufe und sind anwenderfreundlich. Das System erlaubt eine Konfektionierung der Kabel im Feld durch das Akku betriebene AXI PRESS Werkzeugtool. Dies ermöglicht Reparaturen an Kabelbäumen sowie auch die flexible und passgenaue Konfektionierung von Prototypen. Die **EVolution EMC** Kabelverschraubung wurde gezielt für den Einsatz in elektrisch betriebenen Fahrzeugen entwickelt und widersteht somit den härtesten Anforderungen im Betrieb.

### 1 Druckmutter

Bleifreie Ausführung in verschiedenen Grössen; Vereinfachte Montage; Anziehen bis Anschlag (kein Drehmoment erforderlich).

### 2 Dichteinsatz

Höchster IP Schutzgrad; Verdrehschutz des Kabels durch Verzahnung; grosser Temperaturbereich -40 bis 140°C.

### 3 Kontakt- und Stützhülse

Die steckbare EMV-Schirmkontaktlösung garantiert eine schnelle und prozesssichere Montage; hochwertige 360° Kontaktierung.

### 4 Unterteil

Bleifreie Ausführung in 2 Gewindelängen und grosser Lichtweite für die Durchführung von Kabelschuhen.

The **EVolution EMC** cable gland ensures the reliable and durable shield connection of shielded cables in electromobility applications. Its innovative design enables the shield contact to be repeatedly "plugged into" the cable gland's lower part, thus facilitating pre-assembly on the cable. Pre-assembled cable harnesses reduce installation costs, simplify production processes and are user-friendly. The system also allows this pre-assembly work to be carried out in the field using the battery-operated AXI PRESS tool. This enables cable harnesses to be repaired, and prototypes to be flexibly and precisely assembled. The **EVolution EMC** cable gland was specially developed for use in electrically powered vehicles and can therefore withstand the most demanding operating requirements.

### 1 Compression nut

Lead-free version in various sizes; Simplified installation; Just tighten to the stop (no torque required).

### 2 Sealing insert

Highest IP protection level; Anti-rotation design thanks to surface profile; Wide temperature range (-40 to +140°C).

### 3 Contact sleeve and supporting ring

The "pluggable" EMC shield contact solution facilitates quick and reliable installation; Ensures high-quality 360° contact.

### 4 Lower part

Lead-free design in 2 thread lengths and large clearance for cable lugs to pass through.

## Montage / Assembly



1. Kabelschuh durchschieben  
1. Push cable lug through



2. Kontakthülse einstecken  
2. Plug in contact sleeve



3. Dichteinsatz einschieben  
3. Push in sealing insert



4. Druckmutter festziehen  
4. Tighten compression nut

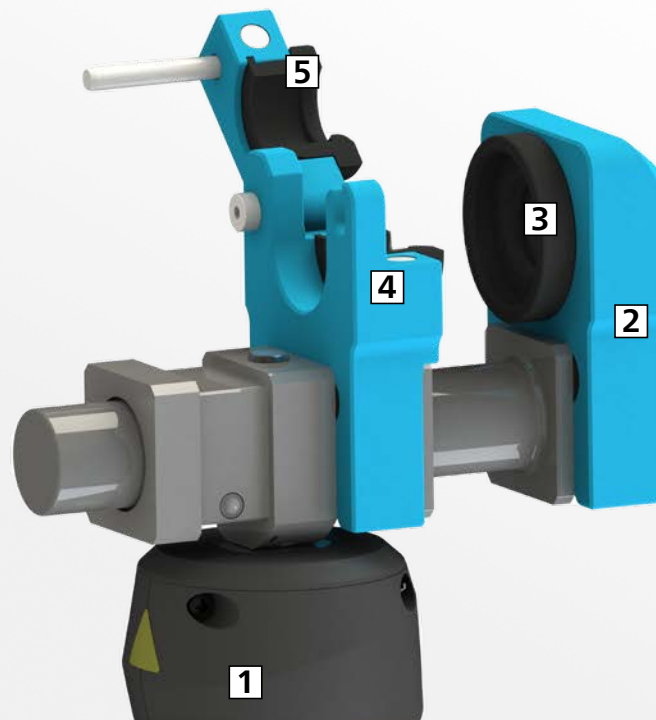

Die **AXI PRESS** wird zur Erstellung des Schirmkontakts für die **Evolution EMC** Kabelverschraubung eingesetzt. Das akkubetriebene Handwerkzeug wird im praktischen Kofferset ausgeliefert, inklusive Ladegerät. Die kabelspezifischen Werkzeugeinsätze sind codiert und können in die Press- und Bördelvorrichtung montiert werden, wo sie über Magnete in Position gehalten werden. Für eine optimierte Arbeitsweise kann die Bördelvorrichtung aufgeklappt werden, um das vorkonfektionierte Kabel einfacher zu entfernen. Über die Infrarot-Schnittstelle können die aufgezeichneten Daten auf einen PC übertragen werden und erlaubt so das Dokumentieren jedes einzelnen Pressvorganges. Die **AXI PRESS** ist ein Markenprodukt und der Service ist weltweit sichergestellt.

### 1 AXI PRESS

Akkuhydraulisches Presswerkzeug; im robusten Koffer mit Ladegerät und Akku; Datenschnittstelle für die Prozessdokumentation; einfachste Bedienung.

### 2 Pressvorrichtung

Halter für Presseinsatz

### 3 Presseinsatz

3 Größen M20, M25 und M32.

### 4 Bördelvorrichtung

Klappbarer Halter für die Bördeleinsätze

### 5 Bördeleinsatz

Auf die HV-Leitungen abgestimmte Einsätze.

The **AXI PRESS** tool is used to crimp the shield contact for the **Evolution EMC** cable gland. The battery-powered handheld tool is supplied in a practical case, including a charger. The cable-specific inserts are coded to ensure proper positioning in the compression and flange devices, where they are held in place by magnets. To remove the pre-assembled cable, the flange device can be opened quickly and easily. The recorded data can be transferred to a computer via the infrared interface, thus facilitating the documentation of each individual use. **AXI PRESS** is a proprietary product, and a maintenance/repair service is ensured worldwide.

### 1 AXI PRESS

Battery-powered hydraulic compression tool; In a robust case with charger and battery; Data interface for process documentation; Simple operation.

### 2 Compression device

Mounting frame for compression insert

### 3 Compression insert

Three sizes – M20, M25 and M32.

### 4 Flange device

Hinged mounting frame for flange inserts

### 5 Flange insert

Two-part insert to suit the HV cable.



### komplett SET Unterteil kurz | complete SET lower part short

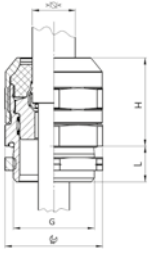

Material: Messing CuZn21Si3P bleifrei  
 Kontaktfeder: Berylliumkupfer  
 Dichtung: Silikon HCR  
 O-Ring: Silikon  
 Schutzart: IP 68 / IP 6K9K  
 Zugentlastung: Ausführung A nach EN 62444  
 Vibrationsfestigkeit: Schwingungsprofil Schärfegrad 3 / Temperaturprofil Schärfegrad 4 nach LV214 gemäss EN 60068-2-14/-27/-27  
 Einsatztemperatur: -40 °C / +140 °C

Material: Brass CuZn21Si3P lead-free  
 Contact spring: beryllium copper  
 Seal: Silicone HCR  
 O-ring: Silicone  
 Protection class: IP 68 / IP 6K9K  
 Strain relief: Version A acc. to EN 62444  
 Vibration strength: Vibration profile sharpness grade 3 / temperature profile sharpness grade 4 to LV214 in accordance with EN 60068-2-14/-27/-27  
 Operation temperature: -40 °C / +140 °C



Komplettes Set  
 Elektromobilität  
 Prozesssichere Verarbeitung

Complet set  
 Electromobility  
 Reliable processing

G	$\begin{matrix} > \text{Ø} < \\ \text{min mm} \end{matrix}$	$\begin{matrix} > \text{Ø} < \\ \text{max mm} \end{matrix}$	$\begin{matrix} \text{H} \\ \text{mm} \end{matrix}$	$\begin{matrix} \text{H} \\ \text{mm} \end{matrix}$	$\begin{matrix} \text{L} \\ \text{mm} \end{matrix}$	Art.-No.	
M20x1.5	8.1	9.1	24	25.5	6	1089.20.090.SETAR1	25
M20x1.5	8.9	10.0	24	25.5	6	1089.20.098.SETAR1	25
M20x1.5	9.5	10.5	24	25.5	6	1089.20.103.SETAR1	25
M20x1.5	10.8	11.9	24	25.5	6	1089.20.114.SETAR1	25
M20x1.5	11.5	12.55	24	25.5	6	1089.20.124.SETAR1	25
M20x1.5	12.4	13.4	24	25.5	6	1089.20.132.SETAR1	25
M20x1.5	13.1	14.15	24	25.5	6	1089.20.139.SETAR1	25
M20x1.5	13.8	14.85	24	25.5	6	1089.20.146.SETAR1	25
M25x1.5	12.4	13.4	30	26.6	7	1089.25.132.SETAR1	25
M25x1.5	13.1	14.15	30	26.6	7	1089.25.139.SETAR1	25
M25x1.5	13.8	14.85	30	26.6	7	1089.25.146.SETAR1	25
M25x1.5	14.5	15.55	30	26.6	7	1089.25.154.SETAR1	25
M25x1.5	15.1	16.15	30	26.6	7	1089.25.160.SETAR1	25
M25x1.5	16.0	17.0	30	26.6	7	1089.25.168.SETAR1	25
M25x1.5	16.6	17.65	30	26.6	7	1089.25.175.SETAR1	25
M25x1.5	17.5	18.55	30	26.6	7	1089.25.184.SETAR1	25
M32x1.5	16.6	17.65	36	23.8	8	1089.32.175.SETAR1	25
M32x1.5	17.5	18.55	36	23.8	8	1089.32.184.SETAR1	25
M32x1.5	19.0	20.1	36	23.8	8	1089.32.200.SETAR1	25
M32x1.5	20.1	21.15	36	23.8	8	1089.32.210.SETAR1	25
M32x1.5	21.5	22.65	36	23.8	8	1089.32.227.SETAR1	25
M32x1.5	22.2	23.25	36	23.8	8	1089.32.231.SETAR1	25

Auf Anfrage lieferbar:  
 Andere Kabeltypen / Querschnitte

Available on request:  
 Other cable types / cross sections

### komplett SET Unterteil lang | complete SET lower part long

Material:	Messing CuZn21Si3P bleifrei	Material:	Brass CuZn21Si3P lead-free
Kontaktfeder:	Berylliumkupfer	Contact spring:	beryllium copper
Dichtung:	Silikon HCR	Seal:	Silicone HCR
O-Ring:	Silikon	O-ring:	Silicone
Schutzart:	IP 68 / IP 6K9K	Protection class:	IP 68 / IP 6K9K
Zugentlastung:	Ausführung A nach EN 62444	Strain relief:	Version A acc. to EN 62444
Vibrationsfestigkeit:	Schwingungsprofil Schärfegrad 3 / Temperaturprofil Schärfegrad 4 nach LV214 gemäss EN 60068-2-14/-27/-27	Vibration strength:	Vibration profile sharpness grade 3 / temperature profile sharpness grade 4 to LV214 in accordance with EN 60068-2-14/-27/-27
Einsatztemperatur:	-40 °C / +140 °C	Operation temperature:	-40 °C / +140 °C

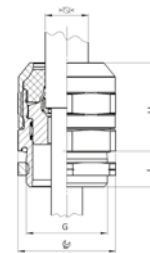

Komplettes Set  
Elektromobilität  
Prozesssichere Verarbeitung

Complet set  
Electromobility  
Reliable processing

G	$\begin{matrix} > \varnothing < \\ \text{min mm} \end{matrix}$	$\begin{matrix} > \varnothing < \\ \text{max mm} \end{matrix}$	$\begin{matrix} \text{H} \\ \text{mm} \end{matrix}$	$\begin{matrix} \text{L} \\ \text{mm} \end{matrix}$	Art.-No.	
M20x1.5	8.1	9.1	24	25.5	1189.20.090.SETAR1	25
M20x1.5	8.95	10.0	24	25.5	1189.20.098.SETAR1	25
M20x1.5	10.0	10.5	24	25.5	1189.20.103.SETAR1	25
M20x1.5	10.8	11.9	24	25.5	1189.20.114.SETAR1	25
M20x1.5	11.9	12.55	24	25.5	1189.20.124.SETAR1	25
M20x1.5	12.55	13.4	24	25.5	1189.20.132.SETAR1	25
M20x1.5	13.4	14.15	24	25.5	1189.20.139.SETAR1	25
M20x1.5	14.15	14.85	24	25.5	1189.20.146.SETAR1	25
M25x1.5	12.55	13.4	30	26.6	1189.25.132.SETAR1	25
M25x1.5	13.4	14.15	30	26.6	1189.25.139.SETAR1	25
M25x1.5	14.15	14.85	30	26.6	1189.25.146.SETAR1	25
M25x1.5	14.85	15.55	30	26.6	1189.25.154.SETAR1	25
M25x1.5	15.55	16.15	30	26.6	1189.25.160.SETAR1	25
M25x1.5	16.15	17.0	30	26.6	1189.25.168.SETAR1	25
M25x1.5	17.0	17.65	30	26.6	1189.25.175.SETAR1	25
M25x1.5	17.65	18.55	30	26.6	1189.25.184.SETAR1	25
M32x1.5	17.0	17.65	36	23.8	1189.32.175.SETAR1	25
M32x1.5	17.65	18.55	36	23.8	1189.32.184.SETAR1	25
M32x1.5	19.0	20.1	36	23.8	1189.32.200.SETAR1	25
M32x1.5	20.1	21.2	36	23.8	1189.32.210.SETAR1	25
M32x1.5	21.5	22.65	36	23.8	1189.32.227.SETAR1	25
M32x1.5	22.15	23.25	36	23.8	1189.32.231.SETAR1	25

Auf Anfrage lieferbar:

Available on request:

Andere Kabeltypen / Querschnitte

Other cable types / cross sections



### Druckmutter | Compression nut

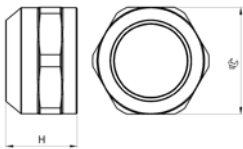

Material: Messing CuZn21Si3P bleifrei  
 Schutzart: IP 68 / IP 6K9K  
 Einsatztemperatur: -40 °C / +140 °C

Material: Brass CuZn21Si3P lead-free  
 Protection class: IP 68 / IP 6K9K  
 Operation temperature: -40 °C / +140 °C



Bleifreies Messing  
 Elektromobilität

Lead-free brass  
 Electromobility

G	 mm	H mm	Art.-No.	
M20x1.5	24	19	<b>1089.20.01LF</b>	25
M25x1.5	30	20	<b>1089.25.01LF</b>	25
M32x1.5	36	17.5	<b>1089.32.01LF</b>	25



### Dichteinsatz | Sealing insert

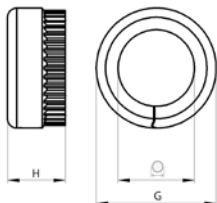

Material: Silikon HCR  
 Schutzart: IP 68 / IP 6K9K  
 Einsatztemperatur: -40 °C / +140 °C

Material: Silicone HCR  
 Protection class: IP 68 / IP 6K9K  
 Operation temperature: -40 °C / +140 °C



Elektromobilität

Electromobility

G	$\begin{matrix} > \varnothing < \\ \text{min mm} \end{matrix}$	$\begin{matrix} > \varnothing < \\ \text{max mm} \end{matrix}$	H mm	Art.-No.	
M20	8.1	9.1	10	<b>1089.20.97.090.03</b>	25
M20	8.95	10.0	10	<b>1089.20.97.098.03</b>	25
M20	10.0	10.5	10	<b>1089.20.97.103.03</b>	25
M20	10.8	11.9	10	<b>1089.20.97.114.03</b>	25
M20	11.9	12.55	10	<b>1089.20.97.124.03</b>	25
M20	12.55	13.4	10	<b>1089.20.97.132.03</b>	25
M20	13.4	14.15	10	<b>1089.20.97.139.03</b>	25
M20	14.15	14.85	10	<b>1089.20.97.146.03</b>	25
M25	12.55	13.4	10	<b>1089.25.97.132.03</b>	25
M25	13.4	14.15	10	<b>1089.25.97.139.03</b>	25
M25	14.15	14.85	10	<b>1089.25.97.146.03</b>	25
M25	14.85	15.55	10	<b>1089.25.97.154.03</b>	25
M25	15.55	16.15	10	<b>1089.25.97.160.03</b>	25
M25	16.15	17.0	10	<b>1089.25.97.168.03</b>	25
M25	17.0	17.65	10	<b>1089.25.97.175.03</b>	25
M25	17.65	18.55	10	<b>1089.25.97.184.03</b>	25
M32	17.0	17.65	10	<b>1089.32.97.175.03</b>	25
M32	17.65	18.55	10	<b>1089.32.97.184.03</b>	25
M32	19.01	20.1	10	<b>1089.32.97.200.03</b>	25
M32	20.1	21.15	10	<b>1089.32.97.210.03</b>	25
M32	21.55	22.65	10	<b>1089.32.97.227.03</b>	25
M32	22.15	23.25	10	<b>1089.32.97.231.03</b>	25



Auf Anfrage lieferbar:  
 Andere Kabeltypen / Querschnitte

Available on request:  
 Other cable types / cross sections

### Unterteil metrisch kurz | Lower part metric short

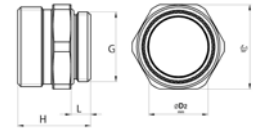

Material:	Messing CuZn21Si3P bleifrei	Material:	Brass CuZn21Si3P lead-free
Kontaktfeder:	Berylliumkupfer	Contact spring:	beryllium copper
O-Ring:	Silikon	O-ring:	Silicone
Schutzart:	IP 68 / IP 6K9K	Protection class:	IP 68 / IP 6K9K
Einsatztemperatur:	-40 °C / +140 °C	Operation temperature:	-40 °C / +140 °C



Bleifreies Messing Elektromobilität				Lead-free brass Electromobility			
G	 mm	L mm	ØD2 mm	Art.-No.			
M20x1.5	24	6	16.1	1089.20.02LF	25		
M25x1.5	30	7	21.1	1089.25.02LF	25		
M32x1.5	36	8	27.4	1089.32.02LF	25		



### Unterteil metrisch lang | Lower part metric long

Bleifreies Messing Elektromobilität				Lead-free brass Electromobility			
G	 mm	L mm	ØD2 mm	Art.-No.			
M20x1.5	24	10	16.1	1189.20.02LF	25		
M25x1.5	30	11	21.1	1189.25.02LF	25		
M32x1.5	36	13	27.4	1189.32.02LF	25		



### Schutzkappe zum Unterteil | Protection cap to lower part

Material:	TPE gelb	Material:	TPE yellow
Einsatztemperatur:	-40 °C / +120 °C	Operation temperature:	-40 °C / +120 °C

Elektromobilität			Electromobility		
G	H mm	Ø mm	Art.-No.		
M20	36.5	24.2	1089.20.20	25	
M25	36.1	30.5	1089.25.25	25	
M32	25.3	37.9	1089.32.32	25	
M40	29.4	44.4	1089.40.40	25	



1  
2  
3  
4  
5  
6  
7  
8  
9  
10  
11  
12  
13  
14  
15

### Kontakthülse R1 | Contact sleeve R1

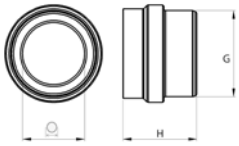

Material: Kupfer  
 EMV-Schirmdämpfung: > 86 dB  
 Einsatztemperatur: -40 °C / +140 °C

Material: Copper  
 EMC attenuation: > 86 dB  
 Operation temperature: -40 °C / +140 °C



Bleifrei Elektromobilität		lead-free Electromobility		Art.-No.	
G	> Ø < min mm	> Ø < max mm			
M20	8.1	9.1		1089.20.090.04.R1	25
M20	8.95	10.0		1089.20.098.04.R1	25
M20	10.0	10.5		1089.20.103.04.R1	25
M20	10.8	11.9		1089.20.114.04.R1	25
M20	11.9	12.55		1089.20.124.04.R1	25
M20	12.55	13.4		1089.20.132.04.R1	25
M20	13.4	14.15		1089.20.139.04.R1	25
M20	14.15	14.85		1089.20.146.04.R1	25
M25	12.55	13.4		1089.25.132.04.R1	25
M25	13.4	14.15		1089.25.139.04.R1	25
M25	14.15	14.85		1089.25.146.04.R1	25
M25	14.85	15.55		1089.25.154.04.R1	25
M25	15.55	16.15		1089.25.160.04.R1	25
M25	16.15	17.0		1089.25.168.04.R1	25
M25	17.0	17.65		1089.25.175.04.R1	25
M25	17.65	18.55		1089.25.184.04.R1	25
M32	17.0	17.65		1089.32.175.04.R1	25
M32	17.65	18.55		1089.32.184.04.R1	25
M32	19.0	20.1		1089.32.200.04.R1	25
M32	20.1	21.2		1089.32.210.04.R1	25
M32	21.5	22.65		1089.32.227.04.R1	25
M32	22.15	23.25		1089.32.231.04.R1	25

Auf Anfrage lieferbar:  
 Andere Kabeltypen / Querschnitte

Available on request:  
 Other cable types / cross sections

### Stützhülse R1 | Supporting ring R1

Material:	Messing CuZn21Si3P bleifrei	Material:	Brass CuZn21Si3P lead-free
EMV-Schirmdämpfung:	> 86 dB	EMC attenuation:	> 86 dB
Einsatztemperatur:	-40 °C / +140 °C	Operation temperature:	-40 °C / +140 °C

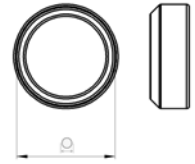

Bleifrei Elektromobilität		lead-free Electromobility		Art.-No.	
 min mm	 max mm				
8.1	9.1			1089.090.05.R1	25
8.95	10.0			1089.098.05.R1	25
10.0	10.5			1089.103.05.R1	25
10.8	11.9			1089.114.05.R1	25
11.9	12.55			1089.124.05.R1	25
12.55	13.4			1089.132.05.R1	25
13.4	14.15			1089.139.05.R1	25
14.15	14.85			1089.146.05.R1	25
14.85	15.55			1089.154.05.R1	25
15.55	16.15			1089.160.05.R1	25
16.15	17.0			1089.168.05.R1	25
17.0	17.65			1089.175.05.R1	25
17.65	18.55			1089.184.05.R1	25
19.0	20.1			1089.200.05.R1	25
20.1	21.2			1089.210.05.R1	25
21.5	22.65			1089.227.05.R1	25
22.15	23.25			1089.231.05.R1	25

Auf Anfrage lieferbar:      Available on request:  
Andere Kabeltypen / Querschnitte      Other cable types / cross sections

1  
2  
3  
4  
5  
6  
7  
8  
9  
10  
11  
12  
13  
14  
15

### AXI PRESS Bördelvorrichtung | AXI PRESS flange device

Material: Alu (AlMgSi0.5)  
Eigenschaften: AXI PRESS EVolution EMC

Material: Alu (AlMgSi0.5)  
Properties: AXI PRESS EVolution EMC



Prozesssichere Verarbeitung  
Elektromobilität

Reliable processing  
Electromobility

L	B	H	i
mm	mm	mm	info
98	66	26	-
105	75	46	1

Art.-No.



4801.00.02	1
4801.00.04	1

1 = Farbe Schwarz

1 = Colour Black



### AXI PRESS Pressvorrichtung | AXI PRESS compression device



Prozesssichere Verarbeitung  
Elektromobilität

Reliable processing  
Electromobility

L	B	H	i
mm	mm	mm	info
98	66	22	-
105	66	22	1

Art.-No.



4801.00.01	1
4801.00.03	1

1 = Farbe Schwarz

1 = Colour Black





### AXI PRESS Presseinsätze | AXI PRESS compression insert

Material:	gehärteter Kaltarbeitsstahl brüniert	Material:	hardened cold work steel burnished
Eigenschaften:	AXI PRESS EVolution EMC	Properties:	AXI PRESS EVolution EMC

Prozesssichere Verarbeitung Elektromobilität	Reliable processing Electromobility		
<b>G</b>		<b>Art.-No.</b>	
M20		4801.20.01	1
M25		4801.25.01	1
M32		4801.32.01	1
M40		4801.40.01	1



### AXI PRESS Bördeleinsätze | AXI PRESS flange insert

Prozesssichere Verarbeitung Elektromobilität	Reliable processing Electromobility		
<b>G</b>		<b>Art.-No.</b>	
M20	9.0	4801.090.01	1
M20	9.8	4801.098.01	1
M20	10.3	4801.103.01	1
M20	11.4	4801.114.01	1
M20	12.4	4801.124.01	1
M20 / M25	13.2	4801.132.01	1
M20 / M25	13.9 / 14.6	4801.139.146.01	1
M25	15.4	4801.154.01	1
M25	16.0	4801.160.01	1
M25	16.8	4801.168.01	1
M25 / M32	17.5	4801.175.01	1
M25 / M32	18.4	4801.184.01	1
M32	20.0	4801.200.01	1
M32	21.0	4801.210.01	1
M32	22.7	4801.227.01	1
M32	23.1	4801.231.01	1
M40	25.0	4801.250.01	1



1  
2  
3  
4  
5  
6  
7  
8  
9  
10  
11  
12  
13  
14  
15

### AXI PRESS Ladegerät | AXI PRESS charger

Eigenschaften: AXI PRESS EVolution EMC Properties: AXI PRESS EVolution EMC



Prozesssichere Verarbeitung  
Elektromobilität

Reliable processing  
Electromobility



220 - 240 V  
110 V

Art.-No.



4801.02EU

1

4801.01USA

1



### AXI PRESS Akku | AXI PRESS akku



Prozesssichere Verarbeitung  
Elektromobilität

Reliable processing  
Electromobility



5.0 Ah

Art.-No.



4801.01

1



### AXI PRESS Zange | AXI PRESS pliers

Eigenschaften: 1 x Zange mit Koffer,  
1 x Ladegerät, 1 x Akku

Properties: 1 x Pliers in the Tool case,  
1 x Charger, 1 x Battery 5 Ah



Prozesssichere Verarbeitung  
Elektromobilität

Reliable processing  
Electromobility

L mm	B mm	H mm	
574	423	170	220 - 240 V
574	423	170	110 V

Art.-No.



4801.EU



1

4801.USA

1





Mehrfachdurchführung MCE Pro Multi Cable Entry MCE Pro		130
Mehrfachdurchführung MCE Pro EMV Multi Cable Entry MCE Pro EMV		131
Flanschverschraubung Progress® M50 Flanged fitting Progress® M50		132

1

2

3

4

5

6

7

8

9

10

11

12

13

14

15



## AGRO MCE Syntec® Die neue Produktlinie im eigenen MCE-Katalog

Unsere neueste Produktlinie umfasst eine breite Palette von verschiedenen Komponenten, die das Durchführen von Kabeln mit oder ohne Stecker wesentlich vereinfachen.

### Die Vorteile:

- Umfangreiches Sortiment an masslich standardisierten Serien
- Mehrbereichstüllen und deren Kompatibilität innerhalb verschiedener Rahmenserien reduzieren den Lagerbestand
- Umfangreiches Zubehör wie Blindabdeckungen, Einschnapp-Rahmen, Dichtstopfen, Tüllen mit Gewindeeinsätzen oder integrierten Druckausgleichselementen uvm.

### Technische Vorteile:

- Doppelmembranen unterstützen die System-Dichtheit
- UL 94 V-0-Kunststoffe begünstigen die Brandhemmung
- IK 10-Schlagtests verbessern die Robustheit unter extremen Einsatzbedingungen
- Einfache und zeitsparende Montage

Die vollständige Übersicht der MCE-Lösungen, einschliesslich der neuen Produktlinie MCE Syntec® und der bewährten MCE Pro Reihe, ist im separaten AGRO MCE-Katalog enthalten.

## AGRO MCE Syntec® The new product line in the dedicated MCE catalog

Our latest product line includes a wide range of components that simplify the implementation of cable feedthroughs – even for cables with pre-fitted connectors.

### The benefits to you:

- Wide range of dimensionally standardised products
- Multi-section grommets and their compatibility with different frame types reduce inventory
- Extensive range of accessories such as dust protection covers, snap-in frames, sealing plugs, grommets with threaded inserts or integrated pressure balance elements, etc.

### Technical advantages:

- Double membranes enhance the system's sealing performance
- UL 94 V-0 plastics improve fire resistance
- IK10 impact testing for robustness under extreme operating conditions
- Simple and time-saving installation

The complete overview of MCE solutions, including the new MCE Syntec® product line and the proven MCE Pro range, is included in the separate AGRO MCE catalog.



## Für eine dichte und prozesssichere Durchführung

Die kompakte Bauweise der AGRO MCE Pro in Kombination mit mehrteiligen multiLAYER-Dichteinheiten basiert auf dem Prinzip der axialen Verpressung. Das System ermöglicht eine sichere und flexible Einführung mehrerer Kabel bei gleichzeitig hoher Dichtheit und Zugentlastung – selbst unter beengten Platzverhältnissen. Die Frontalmontage ohne zusätzliche Hilfsstoffe erleichtert die Installation erheblich und sorgt für eine prozesssichere Abdichtung. Der modulare Aufbau der Dichteinheit erlaubt zudem eine einfache Anpassung an unterschiedliche Kabeldurchmesser.

### Die Vorteile der AGRO MCE Pro im Überblick:

- Hohe Dichtheit IP 6X / IP X8 / IP X9K nach Kabelverschraubungsnorm EN 62444
- Absolute Prozesssicherheit «auf Block angezogen»
- Flexibilität im Klemmbereich durch multiLAYER Dichteinheiten
- Hohe Auszugskräfte nach EN 62444
- Schnell und kostensparend montiert dank Frontal-Montage
- Extrem robust (Schlagzähigkeit)
- Keine Hilfs- und Schmierstoffe nötig
- Vorkonfektionierbarkeit

## For well-sealed and reliable cable entries

The compact design of the AGRO MCE Pro with the integrated multiLAYER sealing element is based on the principle of axial compression. The system facilitates the reliable and flexible feedthrough of multiple cables while simultaneously providing excellent sealing performance and strain relief – even in confined spaces. Installation from the front, without the need for additional materials, simplifies the installation process and ensures reliable sealing. The modular design of the sealing element also facilitates easy adaptation to different cable diameters.

### The advantages of AGRO's MCE Pro at a glance:

- Very good sealing performance (IP 6X / IP X8 / IP X9K) in accordance with the cable gland standard EN 62444
- Absolute process reliability (screws simply tightened "to the stop")
- Flexibility with respect to cable diameter thanks to the use of MultiLAYER sealing elements
- High pull-out forces in accordance with EN 62444
- The installation from the front is quick and cost-effective
- Extremely robust (high impact strength)
- No auxiliary materials or lubricants required
- Suitable for pre-assembly



### Für eine störungsfreie, dichte und prozesssichere Durchführung

Die AGRO MCE Pro EMV kombiniert eine zuverlässige Kabeldurchführung mit einem integrierten EMV-Kontaktprinzip auf Basis der bewährten easyCONNECT-Federtechnologie. Die Kontaktfeder ermöglicht eine sichere, mechanisch entkoppelte Schirmanbindung, die sowohl bei partiell abisolierten als auch bei vollständig freigelegten Kabelschirmen zuverlässig funktioniert.

Die formstabile Feder passt sich variierenden Schirmdurchmessern an und gewährleistet eine gleichmäßige und wieder lösbare Kontaktierung, ohne das Kabelgeflecht zu beschädigen. Das System eignet sich auch für mehrfach gebohrte Dichteinheiten und unterstützt so flexible Kabellayouts. In Verbindung mit der Frontalmontage und der robusten Gehäusekonstruktion entsteht ein hochfunktionales System für Anwendungen mit erhöhten EMV-Anforderungen – einfach zu integrieren und sicher im Betrieb.

#### Die Vorteile der AGRO MCE Pro EMV im Überblick:

- Kraftvoller und sicherer Schirmabgriff durch Feder Kontaktsystem
- Niedrige Transferimpedanzen
- Absolute Prozesssicherheit bezüglich System-Montage, volle Installationskontrolle bezüglich Schirm
- Hohe Dichtheit IP 6X / IP X8 / IP X9K nach Kabelverschraubungsnorm EN 62444
- Flexibilität im Klemmbereich durch multiLAYER-Dichteinheiten

### For problem-free, process-reliable feedthroughs with good sealing

AGRO MCE Pro EMC combines a reliable cable feedthrough with an integrated EMC contact principle based on the proven easyCONNECT spring technology. The contact spring facilitates a secure, mechanically decoupled shield connection that functions reliably with either partially stripped or fully exposed cable shields.

The deformation-resistant spring adapts to varying shield diameters, facilitating a consistent and detachable shield contact without damaging the cable braid. The system is also suitable for multi-holed sealing elements, thus further enhancing cable layout flexibility. Combined with its front mounting and its robust design, this creates a highly functional system for applications with demanding EMC requirements – easy to use and reliable in operation.

#### The advantages of AGRO MCE Pro EMC at a glance:

- Strong and secure shield grip thanks to the spring-based contact system
- Low transfer impedance
- Absolute reliability in terms of system assembly, full installation control with regard to the cable shield
- High degree of sealing (IP 6X / IP X8 / IP X9K) in accordance with the cable gland standard EN 62444
- Flexibility with respect to cable diameter thanks to the use of MultiLAYER sealing elements
- High pull-out forces in accordance with EN 62444
- The installation from the front is quick and cost-effective
- Extremely robust (high impact strength)
- No auxiliary materials or lubricants required



### Flexibilität dank Progress® Baukasten

Die Flanschverschraubung M50 wurde speziell für Anwendungen entwickelt, bei denen eine schnelle, saubere und drehmomentarme Montage im Vordergrund steht. Durch das vollständig frontale Verschraubungskonzept lässt sich das System ohne Verdrehen der Leitungen montieren – ein entscheidender Vorteil bei vorkonfektionierten Kabeln und sensiblen Steckverbindungen.

Die Verschraubung erfolgt in zwei Ebenen: Drei Befestigungsschrauben fixieren das Gehäuse axial am Einbauort, während drei Kompressionsschrauben die Dichteinheiten sicher in Position halten und den definierten Anpressdruck erzeugen. Die geschlitzten Dichteinsätze aus dem Progress® Baukasten ermöglichen die Durchführung konfektionierter Kabel bei großzügiger lichter Weite. Für maximale Flexibilität können kundenspezifische Dichteinsätze realisiert werden.

#### Die Vorteile der AGRO Progress® Flanschverschraubung M50 im Überblick:

- Einfache Montage: frontal verschraubbar mit geringen Anzugsdrehmomenten
- Schnelle Montage mit Ratsche oder Akkuschauber (keine sperrigen Gabelschlüssel)
- Kundenspezifische Dichteinheiten (bezüglich Lochbild, Dichtmaterial etc.)
- Absolute Prozesssicherheit: Anziehen «auf Block»
- Kein Verdrehen des Kabels während der Montage
- Hohe Dichtheit (kundenspezifische Anforderungen umsetzbar)
- Hohe Zugentlastungskräfte
- Eloxiertes Aluminium: höchste Robustheit und Möglichkeit zur Baugruppen-Individualisierung
- Keine weiteren Hilfs- und Schmierstoffe zur Montage erforderlich

### Flexibility thanks to the Progress® modular system.

Progress® Flange M50 was specially developed for applications requiring fast, straightforward and low-torque installation. Its front-mounted design allows it to be installed without twisting the cables – a major advantage for pre-assembled cables and easily disturbed plug-type connections.

The design incorporates two types of screwed connection: Three screws fix the lower part in place at the installation location, and three additional screws connect the upper part to the lower part, holding the sealing element securely in position and generating the required contact pressure. The split sealing inserts from the Progress® modular system enable pre-assembled cables to be fed through with a generous clearance. For maximum flexibility, customised sealing inserts can be provided.

#### The advantages of AGRO's Progress® Flange M50 at a glance:

- Easy installation; can be screwed from the front with low torque
- Quick installation with a ratchet or cordless screwdriver (no awkward open-end wrench required)
- Customised sealing elements (regarding hole pattern, sealing material, etc.)
- Absolute process reliability; tightened manually "to the stop"
- No twisting of cables during installation
- High degree of sealing (customer-specific requirements can be implemented)
- High strain-relief forces
- Anodised aluminium; extremely robust and assembly customisation possible
- No auxiliary materials or lubricants required for installation

# Mehrfachdurchführung MCE, Standard-Varianten

## Multi Cable Entry MCE, Standard variants

### Aluminium gefräst, einteiliges System | Milled aluminium, one-piece system

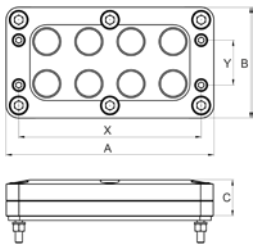

Material: Aluminium eloxiert  
 Dichtung: NBR  
 Flachdichtung: CR (Chloropren-Kautschuck)  
 Zugentlastung: Ausführung nach EN 62444  
 Schutzart: IP 68 = 0.3 bar / 30 min  
 Einsatztemperatur: -30 °C / +105 °C

Material: Aluminium anodised  
 Seal: NBR  
 Flat gasket: CR (chloroprene rubber)  
 Strain relief: Version to EN 62444  
 Protection class: IP 68 = 0.3 bar / 30 min  
 Operation temperature: -30 °C / +105 °C



- Hohe Dichtheit IP 6X / IP X8 / IP X9K nach EN 62444
- Absolute Prozesssicherheit
- Flexibilität im Klemmbereich durch MultiLayer-Dichteinheiten
- Hohe Auszugskräfte nach EN 62444
- Schnell- und kostensparend montiert
- Extrem robust und flexibel
- Keine Hilfs- und Schmierstoffe nötig
- Vorkonfektionierbarkeit

- High tightness IP 6X / IP X8 / IP X9K according to EN 62444
- Absolute process safety
- Flexibility in the clamping area due to multiLAYER sealing units
- High pull-out forces according to EN 62444
- Fast and cost-saving assembly
- Extremely robust and flexible
- No auxiliary materials and lubricants necessary
- Prefabrication

		> Ø <	> Ø <	A	B	C	X	Y		> □ <	Art.-No.	
		min mm	max mm	mm	mm	mm	mm	mm		mm		
<b>MCE 08 / 08 S010</b>	8	4.0	10.0	148	79	26	130	32	M5	112x50	<b>1908.88.08.010</b>	1
<b>MCE 08 / 08 S011</b>	8	6.0	16.0	148	79	26	130	32	M5	112x50	<b>1908.88.08.011</b>	1
<b>MCE 08 / 03 S012</b>	3	10.0	22.5	148	79	26	130	32	M5	112x50	<b>1908.88.03.012</b>	1

### Aluminium gefräst, einteiliges System | Milled aluminium, one-piece system

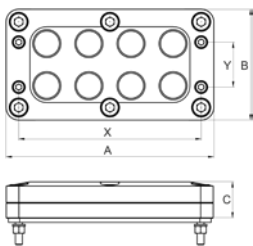

Material: Aluminium eloxiert  
 Dichtung: NBR  
 Flachdichtung: NBR (Acrylnitril-Butadien-Kautschuk)  
 Zugentlastung: Ausführung nach EN 62444  
 Schutzart: IP68 (max. 4 bar während 60 Minuten)  
 Einsatztemperatur: -30 °C / +105 °C

Material: Aluminium anodised  
 Seal: NBR  
 Flat gasket: NBR (acrylonitrile butadiene rubber)  
 Strain relief: Version to EN 62444  
 Protection class: IP68 (max. 4 bar during 60 minutes)  
 Operation temperature: -30 °C / +105 °C



- Hohe Dichtheit IP 6X / IP X8 / IP X9K nach EN 62444
- Absolute Prozesssicherheit
- Flexibilität im Klemmbereich durch MultiLayer-Dichteinheiten
- Hohe Auszugskräfte nach EN 62444
- Schnell- und kostensparend montiert
- Extrem robust und flexibel
- Keine Hilfs- und Schmierstoffe nötig
- Vorkonfektionierbarkeit

- High tightness IP 6X / IP X8 / IP X9K according to EN 62444
- Absolute process safety
- Flexibility in the clamping area due to multiLAYER sealing units
- High pull-out forces according to EN 62444
- Fast and cost-saving assembly
- Extremely robust and flexible
- No auxiliary materials and lubricants necessary
- Prefabrication

		> Ø <	> Ø <	A	B	C	X	Y		> □ <	Art.-No.	
		min mm	max mm	mm	mm	mm	mm	mm		mm		
<b>MCE 08 / 08 S020</b>	8	4.0	10.0	148	79	26	130	32	M5	112x50	<b>1908.88.08.020</b>	1
<b>MCE 08 / 08 S021</b>	8	6.0	16.0	148	79	26	130	32	M5	112x50	<b>1908.88.08.021</b>	1
<b>MCE 08 / 03 S022</b>	3	10.0	22.5	148	79	26	130	32	M5	112x50	<b>1908.88.03.022</b>	1

### Aluminium gefräst, einteiliges System | Milled aluminium, one-piece system

Material:	Alu eloxiert / vernickelt	Material:	Alu anodised / nickel-plated
Dichtung:	NBR	Seal:	NBR
Flachdichtung:	CR (Chloropren-Kautschuck)	Flat gasket:	CR (chloroprene rubber)
Zugentlastung:	Ausführung nach EN 62444	Strain relief:	Version to EN 62444
Schutzart:	IP 68 = 0.3 bar / 30 min	Protection class:	IP 68 = 0.3 bar / 30 min
Einsatztemperatur:	-30 °C / +105 °C	Operation temperature:	-30 °C / +105 °C

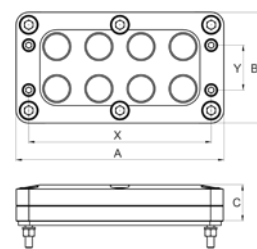

- Kraftvoller und sicherer Schirmabgriff durch Feder-Kontaktsystem
  - Niedrige Transferimpedanzen
  - Absolute Prozesssicherheit bezüglich System-Montage, volle Installationskontrolle bezüglich Schirm
  - Hohe Dichtheit IP 6X / IP X8 / IP X9K nach EN 62444
  - Flexibilität im Klemmbereich durch MultiLayer-Dichteinheiten
  - Hohe Auszugskräfte nach EN 62444
  - Extrem robust (Schlagzähigkeit)
  - Keine Hilfs- und Schmierstoffe nötig
- Powerful and safe clamping shield due to spring con tact system
  - Low transfer impedance
  - Absolute process safety with regard to system assembly, full installation control with regard to screen
  - High tightness IP 6X / IP X8 / IP X9K according to EN 62444
  - Flexibility in the clamping area due to multiLAYER sealing units
  - High pull-out forces according to EN 62444
  - Extremely robust (impact resistance)
  - No auxiliary materials and lubricants necessary



					A	B	C	X	Y			Art.-No.		
	min mm	max mm	min mm	max mm	mm	mm	mm	mm	mm		mm			
<b>MCE 08 / 08 S101</b>	8	4.0	10.0	3.5	12.0	148	79	26	130	32	M5	112x50	<b>1908.88.08.83.101</b>	1
<b>MCE 08 / 08 S102</b>	8	6.0	16.0	4.5	17.0	148	79	26	130	32	M5	112x50	<b>1908.88.08.83.102</b>	1
<b>MCE 08 / 03 S103</b>	3	10.0	22.5	7.5	21.0	148	79	26	130	32	M5	112x50	<b>1908.88.03.83.103</b>	1

### Aluminium gefräst, einteiliges System | Milled aluminium, one-piece system

Material:	Alu eloxiert / vernickelt	Material:	Alu anodised / nickel-plated
Dichtung:	NBR	Seal:	NBR
Flachdichtung:	NBR (Acrylnitril-Butadien-Kautschuk)	Flat gasket:	NBR (acrylonitrile butadiene rubber)
Zugentlastung:	Ausführung nach EN 62444	Strain relief:	Version to EN 62444
Schutzart:	IP68 (max. 4 bar während 60 Minuten)	Protection class:	IP68 (max. 4 bar during 60 minutes)
Einsatztemperatur:	-30 °C / +105 °C	Operation temperature:	-30 °C / +105 °C

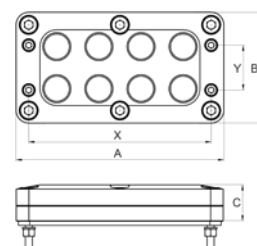

- Kraftvoller und sicherer Schirmabgriff durch Feder-Kontaktsystem
  - Niedrige Transferimpedanzen
  - Absolute Prozesssicherheit bezüglich System-Montage, volle Installationskontrolle bezüglich Schirm
  - Hohe Dichtheit IP 6X / IP X8 / IP X9K nach EN 62444
  - Flexibilität im Klemmbereich durch MultiLayer-Dichteinheiten
  - Hohe Auszugskräfte nach EN 62444
  - Extrem robust (Schlagzähigkeit)
  - Keine Hilfs- und Schmierstoffe nötig
- Powerful and safe clamping shield due to spring con tact system
  - Low transfer impedance
  - Absolute process safety with regard to system assembly, full installation control with regard to screen
  - High tightness IP 6X / IP X8 / IP X9K according to EN 62444
  - Flexibility in the clamping area due to multiLAYER sealing units
  - High pull-out forces according to EN 62444
  - Extremely robust (impact resistance)
  - No auxiliary materials and lubricants necessary



					A	B	C	X	Y			Art.-No.		
	min mm	max mm	min mm	max mm	mm	mm	mm	mm	mm		mm			
<b>MCE 08 / 08 S111</b>	8	4.0	10.0	3.5	12.0	148	79	26	130	32	M5	112x50	<b>1908.88.08.83.111</b>	1
<b>MCE 08 / 08 S112</b>	8	6.0	16.0	4.5	17.0	148	79	26	130	32	M5	112x50	<b>1908.88.08.83.112</b>	1
<b>MCE 08 / 03 S113</b>	3	10.0	22.5	7.5	21.0	148	79	26	130	32	M5	112x50	<b>1908.88.03.83.113</b>	1

# Flansch-Verschraubung Progress M50

## Flanged fitting Progress M50

### Polyamid PA6 | Polyamide PA6

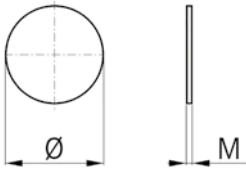

Material: Polyamid PA 6  
 Materialdicke: 0.3 mm  
 Schutzart: IP 68 = 2 bar / 30 min  
 Einsatztemperatur: -20 °C / +100 °C

Material: Polyamide PA 6  
 Material thickness: 0.3 mm  
 Protection class: IP 68 = 2 bar / 30 min  
 Operation temperature: -20 °C / +100 °C



Blindscheibe als Staubschutz

Blind disc for dust protection

Ø mm	M mm	Art.-No.	
23.5	0.3	<b>1908.20.235.05</b>	50
26.5	0.3	<b>1908.25.265.05</b>	50
34.3	0.3	<b>1908.32.343.05</b>	50

### Aluminium gefräst, einteiliges System | Milled aluminium, one-piece system

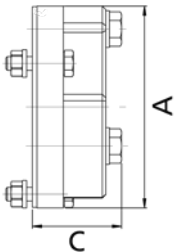

Material: Aluminium eloxiert  
 Dichtung: Progress Baukasten-System, kundenspezifische Ausführung  
 Flachdichtung: CR sowie NBR  
 Schutzart: Nach Kundenanforderung  
 Einsatztemperatur: -40 °C / +100 °C

Material: Aluminium anodised  
 Seal: Progress modular system, customised design  
 Flat gasket: CR as well as NBR  
 Protection class: According to the customer's request  
 Operation temperature: -40 °C / +100 °C





- Einfache Montage; frontal verschraubbar mit geringen Anzugsdrehmomenten
- Schnelle Montage mit Ratsche oder Akkuschauber (keine sperrigen Gabelschlüssel)
- Kundenspezifische Dichteinheiten (bezüglich Lochbild, Dichtmaterial etc.)
- Absolute Prozesssicherheit; Anziehen „auf Block“
- Kein Verdrehen des Kabels während der Montage
- Hohe Dichtheit (kundenspezifische Anforderungen umsetzbar)
- Hohe Zugentlastungskräfte
- Eloxiertes Aluminium: höchste Robustheit und Möglichkeit zur Baugruppen-Individualisierung
- Keine Hilfs- und Schmierstoffe nötig

- Simple mounting; frontal screw mounting with low tightening torques
- Quick assembly with ratchet or cordless screwdriver (no bulky open-end spanners)
- Customised sealing units (with regard to hole pattern, sealing material, etc.)
- Absolute process safety; tightening „on block“
- No twisting of the cable during assembly
- High tightness (customer-specific requirements can be implemented)
- High strain relief forces
- Anodised aluminium: highest robustness and possibility of subassembly customisation
- No auxiliary materials and lubricants necessary

	A mm	C mm	> Ø < min mm	> Ø < max mm	Art.-No.	
1	88	39			<b>1988.88.001</b>	1



<p>Kabelverschraubungen Progress® nach EN 45545-2/-3 und NFPA 130                  Cable glands Progress® according to EN 45545-2/3 and NFPA 130</p>		<p>137 - 142</p>	1
<p>Kabelverschraubungen Progress® nach EN 45545-2/-3 und NFPA 130                  für mehrere Kabel                  Cable glands Progress® according to EN 45545-2/3 and NFPA 130                  for installation of multiple cables</p>		<p>143 - 144</p>	2
<p>Kabelverschraubungen Progress® nach EN 45545-2/-3 und NFPA 130                  mit Knickschutzfeder                  Cable glands Progress® according to EN 45545-2/3 and NFPA 130                  with antikink spring</p>		<p>145</p>	3
<p>Kabelverschraubungen Progress® nach EN 45545-2/-3 und NFPA 130                  mit Klemmbacken                  Cable glands Progress® according to EN 45545-2/3 and NFPA 130                  with clamps</p>		<p>146</p>	4
<p>Kabelverschraubungen Progress® nach EN 45545-2/-3 und NFPA 130                  EMV easyCONNECT Messing mit Kontaktfeder                  Cable glands Progress® according to EN 45545-2/3 and NFPA 130                  EMC easyCONNECT with contact spring</p>		<p>147</p>	5
<p>Kabelverschraubungen Progress® nach EN 45545-2/-3 und NFPA 130                  EMV powerCONNECT Messing                  Cable glands Progress® according to EN 45545-2/3 and NFPA 130                  EMC powerCONNECT nickel-plated brass</p>		<p>148</p>	6
<p>Kabelverschraubungen Progress® nach EN 45545-2/-3 und NFPA 130                  EMV Serie 85 Messing mit Spannzange                  Cable glands Progress® according to EN 45545-2/3 and NFPA 130                  EMC Serie 85 nickel-plated brass with collet chuck</p>		<p>149</p>	7

10

11

12

13

14

15

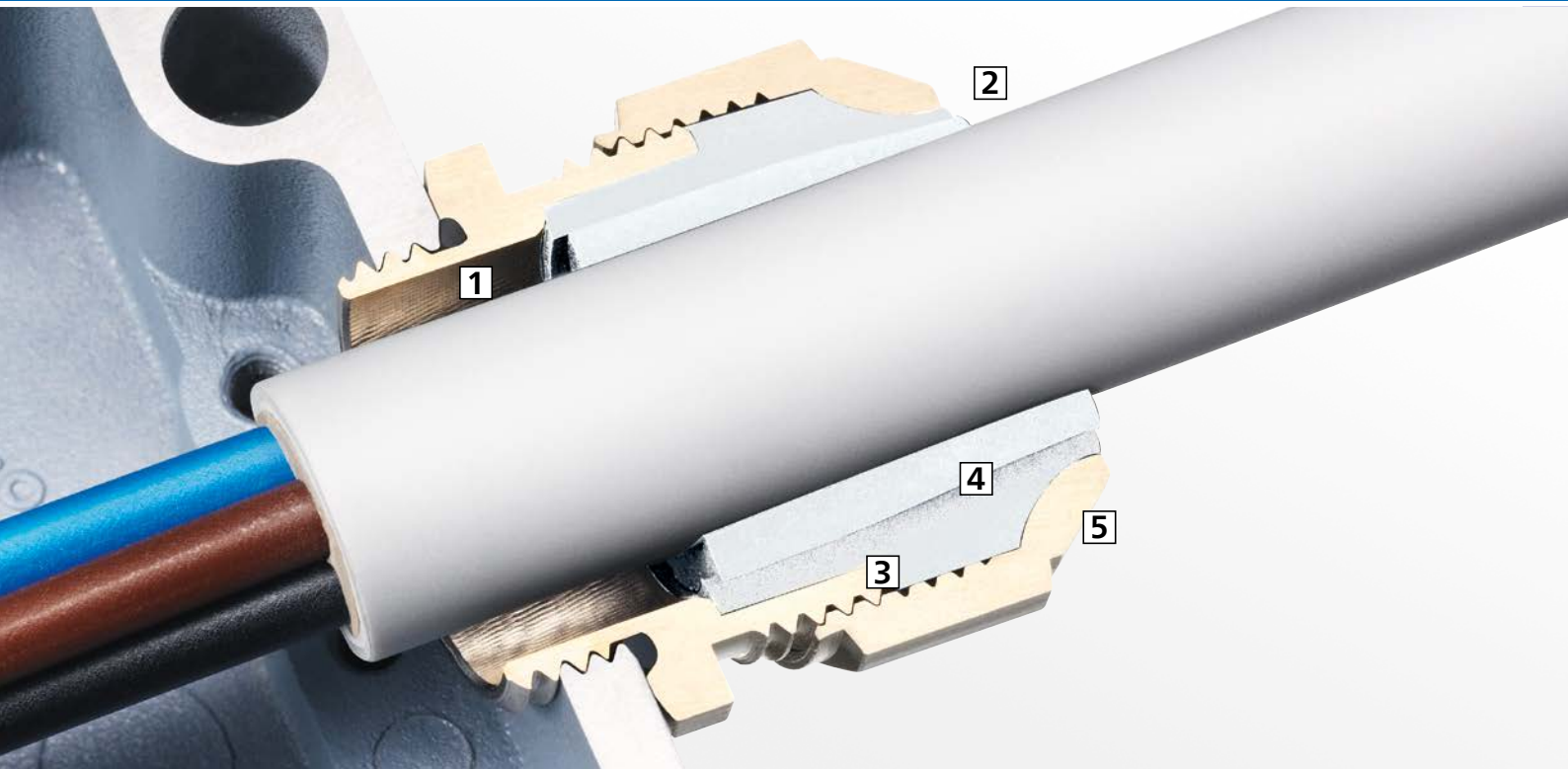

**AGRO Kabelverschraubungen Progress® in Metall für den Einsatz in Schienenfahrzeugen**

AGRO Progress® Kabelverschraubungen aus Metall können mit Dichteinsätzen aus einem speziellem TPE bestückt werden. In dieser Ausführung sind sie zertifiziert nach EN 45545 sowie NFPA 130 und können bedenkenlos für alle Anwendungen und Anordnungen im Schienenfahrzeugbau eingesetzt werden.

**1 Kurze, lange oder Spezial-Anschlussgewinde**

Kabelverschraubungen Progress® mit kurzem oder langem Anschlussgewinde in metrischer oder Pg-Ausführung können bei vorhandenem Öffnungsgewinde oder mit Gegenmutter verwendet werden.

**2 Sichtbare Sicherheit**

Der kleine Wulst des Dichteinsatzes bestätigt das richtige Anzugsdrehmoment.

**3 Hoher Verdrehenschutz**

Die im Unterteil integrierte Längsrandrierung sorgt über den Dichteinsatz für eine hohe Verdrehsicherheit.

**4 Kompressionstechnik**

Die ein- oder zweiteiligen Dichteinsätze werden durch die Druckmutter verpresst und eine ausserordentlich kabelschonende Zugentlastung wird erreicht. Der Kabelmantel bleibt selbst bei dynamischen Anwendungen langfristig intakt.

**5 Garantierte Dichtigkeit**

Auf den Dichteinsatz abgestimmte Innenkonturen sorgen für einzielgerichtete Verformung des Dichteinsatzes und garantieren somit dessen perfekte Abdichtung. Die Schutzarten IP 68 bis 10 bar sowie IP 69 ermöglichen eine breite Anwendung.

**AGRO metal cable glands Progress® for rolling stock applications**

AGRO Progress® metal cable glands can be equipped with sealing inserts made of a special TPE. These versions are certified according to EN 45545 and NFPA 130 and can be used with confidence for any rolling stock application.

**1 Short, long or special entry thread**

Cable glands Progress® with short or long entry thread designed as metric or Pg can be used with existing hole threads or with a counter nut.

**2 Visible reliability**

The small bulge in the sealing insert confirms the correct tightening torque.

**3 Good anti-rotation protection**

The integrated retaining grooves in the lower part and in the sealing insert protect against rotation.

**4 Compression technology**

The one- or two-part sealing inserts are compressed by the compression nut. A very cable-protecting strain relief is produced. The cable jacket will not be harmed, even in case of long-term dynamic stress.

**5 Guaranteed seal**

Inner contours matched to the sealing insert ensure a targeted deformation of the insert and thus guarantee its tightness in compliance with protection class IP 68 up to 10 bar and IP 69 for a wide range of applications.



**Beste Resultate bei Prüfungen nach EN 45545-2 (Komponenten)**

Die Dichteinsätze der Progress® Kabelverschraubung sind aus einem speziellen TPE gefertigt und sind im anspruchsvollsten **Hazard Level 3 (R22/R23) zertifiziert**.

Die geforderten Werte für Hazard Level 3 wurden sowohl im Aussen- als auch im Innenbereich deutlich übertroffen:

**Best results in testing according to EN 45545-2 (Components)**

The seal inserts of Progress® cable glands are made of a special TPE and **certified to the demanding Hazard Level 3 (R22/R23)**.

The stipulated values for Hazard Level 3 were exceeded, for both indoor and outdoor areas

	Normwert für HL 3 aussen Requirement for HL 3 outdoor	Normwert für HL 3 innen Requirement for HL 3 indoor	AGRO Resultat AGRO result
Sauerstoffindex Oxygen index	Min. 32%	Min. 32%	<b>39%</b>
Rauchgasdichte Ds Smoke density Ds	Max. 300	Max. 150	<b>110</b>
Toxizität CIT Toxicity CIT	Max. 1.5	Max. 0.75	<b>0.16</b>

**Vorgaben der EN 45545-3 übertroffen!**

Ziel der **EN 45545-3** ist es, die Brandausbreitung durch Materialanforderungen zu begrenzen. Wenn Kabel durch Feuerschutzabschlüsse geführt werden, gelten diese Anforderungen auch für Kabelverschraubungen.

AGRO Progress® Kabelverschraubungen aus Metall übertreffen die Vorgaben der **EN 45545-3** bei weitem und erreichen die sehr hohe Feuerwiderstandsklasse **E30**. Die Dichteinsätze sind mindestens 30 Minuten lang dicht und verhindern einen Flammenübertrag auf die dem Feuer abgewandte Seite und es bilden sich keine Spalten. Sie können aus brandschutztechnischer Sicht bedenkenlos in allen Schienenfahrzeugen eingesetzt werden.

**Exceeding the demands of EN 45545-3!**

The aim of **EN 45545-3** is to limit fire spread by specifying the performance of materials and components. If cables are routed through fire barriers, the requirements apply also to the cable glands used.

AGRO Progress® metal cable glands easily exceed the requirements of **EN 45545-3** and satisfy the very high demands of fire resistance class **E30**. This means that the seal inserts remain impervious and prevent the spread of fire through the gland for at least 30 minutes. They do not crack or fissure. From a fire protection perspective, they can be used without hesitation in all railway vehicles.

	Einbaulage vertikal Vertical installation	Einbaulage horizontal Horizontal installation	Klassierung Classification
AGRO Resultat AGRO Result	44 min	41 min	<b>E30</b>

	Progress® Messing Progress® nickel-plated brass	Standard Standard	EMV Kabelverschraubungen EMC cable glands	Kombi-Schlauchverschraubungen Combination conduit glands	Winkel 90°+45° Elbow 90°+45°	Für mehrere Kabel For multiple cables	Mit Dichteinsatz With sealing insert	Für spezielle Kabel For special cables	Mit Knickschutzfeder With anti-kink spring	Mit Trompete und / oder Klemmbacken With trumpet and / or clamps
<b>Ausführung / Design</b>										
Kompressionstechnik Compression technology	•	•	•	•	•	•	•	•	•	•
<b>Gewinde / Thread</b>										
Anschlussgewinde metrisch Entry thread metric	•	•	•	•	•	•	•	•	•	•
Anschlussgewinde Pg Entry thread Pg	•	•	•	•	•	•	•	•	•	•
Kurzes Anschlussgewinde (Standard) Short entry thread (standard)	•	•	•	•	•	•	•	•	•	•
Langes Anschlussgewinde Long entry thread	•	•	•	•	•	•	•	•	•	•
Sondergewinde (extra lang, Innengewinde) Special thread (extra-long, internal thread)	•	-	-	-	-	-	-	-	-	-
<b>Dichteinsatz nach EN 45545 / Sealing insert according to EN 45545</b>										
Für Rundkabel For round cables	•	•	•	•	•	-	-	•	•	•
Für Flachkabel For flat cables	•	-	-	-	-	-	•	-	-	-
Für mehrere Kabel (Multi-Dichteinsatz) For several cables (Multi-sealing insert)	•	•	-	-	•	-	-	-	-	-
Vollgummi-Dichteinsatz Solid rubber sealing insert	•	•	-	-	-	•	-	-	-	-
Einteiliger Dichteinsatz One-piece sealing insert	•	•	-	-	•	•	•	•	-	-
Zweiteiliger Dichteinsatz Two-piece sealing insert	•	•	•	•	-	-	-	•	•	•
<b>Technische Besonderheiten / Technical features</b>										
Vibrationsschutz Vibration resistance	•	•	•	•	•	•	•	•	•	•
<b>Material / Material</b>										
Messing vernickelt Nickel-plated brass	•	•	•	•	•	•	•	•	•	•
Rostfreier Stahl A2 Stainless steel A2	•	-	-	-	•	•	•	-	-	-

# Kabelverschraubungen Progress® nach EN 45545-2/3 und NFPA 130

## Cable glands Progress® according to EN 45545-2/3 and NFPA 130

### Kurzes Anschlussgewinde metrisch | Short entry thread metric

Material:	Messing vernickelt	Material:	Nickel-plated brass
Dichtung:	Spezial AGRO TPE hellgrau	Seal:	Special AGRO TPE light grey
O-Ring:	NBR	O-ring:	NBR
Zugentlastung:	Ausführung A nach EN 62444	Strain relief:	Version A acc. to EN 62444
Schutzart:	IP 68 (bis 10 bar) / IP 69	Protection class:	IP 68 (up to 10 bar) / IP 69
Einsatztemperatur:	-50 °C / +105 °C	Operation temperature:	-50 °C / +105 °C

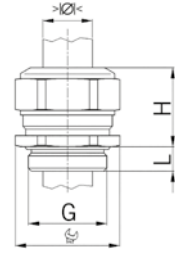

Einteiliger Dichteinsatz  
Durchgehend isolierend

One-piece sealing insert  
overall length insulated

G	$\varnothing_{\text{min}}$	$\varnothing_{\text{max}}$	$\varnothing_{\text{mm}}$	H mm	L mm	i info	Art.-No.	
M6x1.0	2.0	2.5	8	12	5	1	F1060.06.025	50
M6x1.0	2.5	3.0	8	12	5	1	F1060.06.030	50
M8x1.25	2.5	3.0	11	14	5	1	F1060.08.030	50
M8x1.25	3.0	4.0	11	14	5	1	F1060.08.040	50
M10x1.5	3.0	4.0	13	15	5	1	F1060.10.040	50
M10x1.5	4.0	6.0	13	15	5	1	F1060.10.060	50
M12x1.5	3.5	5.0	15	17	5	-	F1060.12.050	50
M12x1.5	5.0	6.5	15	17	5	-	F1060.12.065	50
M12x1.5	6.5	7.5	15	17	5	-	F1060.12.075	50
M16x1.5	4.5	6.0	18	20	5	-	F1060.17.060	50
M16x1.5	6.0	8.0	18	20	5	-	F1060.17.080	50
M16x1.5	8.0	10.5	18	22	5	-	F1060.17.105	50
M20x1.5	6.0	8.0	24	21	6	-	F1060.20.080	50
M20x1.5	8.0	11.0	24	21	6	-	F1060.20.110	50
M20x1.5	11.0	14.5	24	23	6	-	F1060.20.145	50
M25x1.5	9.5	12.5	30	25	7	-	F1060.25.125	25
M25x1.5	12.5	16.0	30	25	7	-	F1060.25.160	25
M25x1.5	16.0	19.0	30	28	7	-	F1060.25.190	25
M32x1.5	17.0	21.0	36	28	8	-	F1060.32.210	25
M32x1.5	21.0	25.5	36	28	8	-	F1060.32.255	25
M40x1.5	24.0	28.5	46	31	8	-	F1060.40.285	10
M40x1.5	28.5	33.0	46	31	8	-	F1060.40.330	10
M50x1.5	33.0	37.0	55	34	9	-	F1060.50.370	10
M50x1.5	37.0	42.0	55	34	9	-	F1060.50.420	10
M63x1.5	40.0	46.0	70	37	10	-	F1060.63.460	5
M63x1.5	46.0	52.0	70	37	10	-	F1060.63.520	5
M75x1.5	50.0	56.0	80	38	11	-	F1060.75.560	1
M75x1.5	56.0	63.0	80	80	11	-	F1060.75.630	1



1 = Metrisches Regelgewinde

1 = Metric coarse-pitch thread

Auf Anfrage lieferbar:

Available on request:

Anschlussgewinde Pg und NPT

Entry thread Pg and NPT

Zweiteiliger Dichteinsatz  
Durchgehend isolierend

Two-piece sealing insert  
overall length insulated

G	$\varnothing_{\text{min}}$	$\varnothing_{\text{max}}$	$\varnothing_{\text{min}}$	$\varnothing_{\text{max}}$	$\varnothing_{\text{mm}}$	H mm	L mm	Art.-No.	
M16x1.5	6.0	8.0	8.0	10.5	18	22	5	F1060.17	50
M20x1.5	8.0	11.0	11.0	14.5	24	23	6	F1060.20	50
M25x1.5	12.5	16.0	16.0	19.0	30	28	7	F1060.25	25
M32x1.5	17.0	21.0	21.0	25.5	36	28	8	F1060.32	25
M40x1.5	24.0	28.5	28.5	33.0	46	31	8	F1060.40	10
M50x1.5	33.0	37.0	37.0	42.0	55	34	9	F1060.50	10
M63x1.5	41.0	46.0	46.0	52.0	70	37	10	F1060.63	5
M75x1.5	50.0	56.0	56.0	63.0	80	38	11	F1060.75	1

Auf Anfrage lieferbar:

Available on request:

Anschlussgewinde Pg und NPT

Entry thread Pg and NPT

# Kabelverschraubungen Progress® nach EN 45545-2/3 und NFPA 130

## Cable glands Progress® according to EN 45545-2/3 and NFPA 130

### Kurzes Anschlussgewinde metrisch | Short entry thread metric

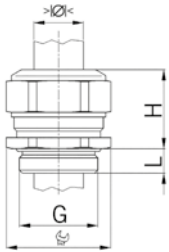

Material: Messing vernickelt  
 Dichtung: Spezial AGRO TPE hellgrau  
 O-Ring: NBR  
 Zugentlastung: Ausführung A nach EN 62444  
 Schutzart: IP 68 (bis 10 bar) / IP 69  
 Einsatztemperatur: -50 °C / +105 °C

Material: Nickel-plated brass  
 Seal: Special AGRO TPE light grey  
 O-ring: NBR  
 Strain relief: Version A acc. to EN 62444  
 Protection class: IP 68 (up to 10 bar) / IP 69  
 Operation temperature: -50 °C / +105 °C



Einteiliger Dichteinsatz  
 Nicht durchgehend isolierend

One-piece sealing insert  
 not overall length insulated

G	>math>D_1</math> min mm	>math>D_2</math> max mm	>math>S</math> mm	H mm	L mm	i info	Art.-No.	
M6x1.0	2.0	2.5	8	12	5	1	F1000.06.025	50
M6x1.0	2.0	2.5	8	12	5	1	F1000.06.030	50
M6x1.0	3.0	3.5	8	12	5	1	F1000.06.035	50
M8x1.25	2.5	3.5	11	14	5	1	F1000.08.035	50
M8x1.25	3.5	5.0	11	14	5	1	F1000.08.050	50
M10x1.5	3.0	4.0	13	15	5	1	F1000.10.040	50
M10x1.5	4.0	6.0	13	15	5	1	F1000.10.060	50
M12x1.5	3.5	5.0	15	17	5	-	F1000.12.050	50
M12x1.5	5.0	6.5	15	17	5	-	F1000.12.065	50
M12x1.5	6.5	8.0	15	17	5	-	F1000.12.080	50
M16x1.5	3.5	4.5	18	20	5	-	F1000.17.045	50
M16x1.5	4.5	6.0	18	20	5	-	F1000.17.060	50
M16x1.5	6.0	8.0	18	20	5	-	F1000.17.080	50
M16x1.5	8.0	10.5	18	22	5	-	F1000.17.105	50
M20x1.5	6.0	8.0	24	21	6	-	F1000.20.080	50
M20x1.5	8.0	11.0	24	21	6	-	F1000.20.110	50
M20x1.5	11.0	15.0	24	23	6	-	F1000.20.150	50
M25x1.5	9.5	12.5	30	25	7	-	F1000.25.125	25
M25x1.5	12.5	16.0	30	27	7	-	F1000.25.160	25
M25x1.5	16.0	20.5	30	28	7	-	F1000.25.205	25
M32x1.5	14.0	17.0	36	28	8	-	F1000.32.170	25
M32x1.5	17.0	21.0	36	28	8	-	F1000.32.210	25
M32x1.5	21.0	25.5	36	28	8	-	F1000.32.255	25
M40x1.5	20.0	24.0	46	31	8	-	F1000.40.240	10
M40x1.5	24.0	28.5	46	31	8	-	F1000.40.285	10
M40x1.5	28.5	33.0	46	31	8	-	F1000.40.330	10
M50x1.5	29.0	33.0	55	34	9	-	F1000.50.330	10
M50x1.5	33.0	37.0	55	34	9	-	F1000.50.370	10
M50x1.5	37.0	42.0	55	34	9	-	F1000.50.420	10
M63x1.5	35.0	40.0	70	37	10	-	F1000.63.400	5
M63x1.5	40.0	46.0	70	37	10	-	F1000.63.460	5
M63x1.5	46.0	52.0	70	37	10	-	F1000.63.520	5
M75x1.5	45.0	50.0	80	38	11	-	F1000.75.500	1
M75x1.5	50.0	56.0	80	38	11	-	F1000.75.560	1
M75x1.5	56.0	63.0	80	38	11	-	F1000.75.630	1

1 = Metrisches Regelgewinde

1 = Metric coarse-pitch thread

Auf Anfrage lieferbar:

Available on request:

Anschlussgewinde Pg und NPT

Entry thread Pg and NPT

# Kabelverschraubungen Progress® nach EN 45545-2/3 und NFPA 130

## Cable glands Progress® according to EN 45545-2/3 and NFPA 130

### Kurzes Anschlussgewinde metrisch | Short entry thread metric

Material:	Messing vernickelt	Material:	Nickel-plated brass
Dichtung:	Spezial AGRO TPE hellgrau	Seal:	Special AGRO TPE light grey
O-Ring:	NBR	O-ring:	NBR
Zugentlastung:	Ausführung A nach EN 62444	Strain relief:	Version A acc. to EN 62444
Schutzart:	IP 68 (bis 10 bar) / IP 69	Protection class:	IP 68 (up to 10 bar) / IP 69
Einsatztemperatur:	-50 °C / +105 °C	Operation temperature:	-50 °C / +105 °C

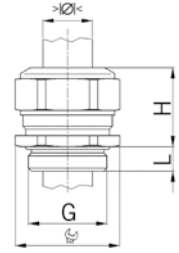

Zweiteiliger Dichteinsatz  
Nicht durchgehend isolierend

Two-piece sealing insert  
not overall length insulated

G	$\varnothing_{\text{min}}$	$\varnothing_{\text{max}}$	$\varnothing_{\text{min}}$	$\varnothing_{\text{max}}$	$\varnothing_{\text{min}}$	$\varnothing_{\text{max}}$	H mm	L mm	Art.-No.	
M16x1.5	6.0	8.0	8.0	10.5	18	22	5	F1000.17	50	
M20x1.5	8.0	11.0	11.0	15.0	24	23	6	F1000.20	50	
M25x1.5	12.5	16.0	16.0	20.5	30	28	7	F1000.25	25	
M32x1.5	17.0	21.0	21.0	25.5	36	28	8	F1000.32	25	
M40x1.5	24.0	28.0	28.0	33.0	46	31	8	F1000.40	10	
M50x1.5	33.0	37.0	37.0	42.0	55	34	9	F1000.50	10	
M63x1.5	40.0	46.0	46.0	52.0	70	37	10	F1000.63	5	
M75x1.5	50.0	56.0	56.0	63.0	80	38	11	F1000.75	1	

Auf Anfrage lieferbar:

Available on request:

Anschlussgewinde Pg und NPT

Entry thread Pg and NPT



# Kabelverschraubungen Progress® nach EN 45545-2/3 und NFPA 130

## Cable glands Progress® according to EN 45545-2/3 and NFPA 130

### Langes Anschlussgewinde metrisch | Long entry thread metric

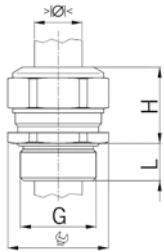

Material: Messing vernickelt  
 Dichtung: Spezial AGRO TPE hellgrau  
 O-Ring: NBR  
 Zugentlastung: Ausführung A nach EN 62444  
 Schutzart: IP 68 (bis 10 bar) / IP 69  
 Einsatztemperatur: -50 °C / +105 °C

Material: Nickel-plated brass  
 Seal: Special AGRO TPE light grey  
 O-ring: NBR  
 Strain relief: Version A acc. to EN 62444  
 Protection class: IP 68 (up to 10 bar) / IP 69  
 Operation temperature: -50 °C / +105 °C



Einteiliger Dichteinsatz  
 Durchgehend isolierend

One-piece sealing insert  
 overall length insulated

G	$\begin{matrix} > < \\ \text{min mm} \end{matrix}$	$\begin{matrix} > < \\ \text{max mm} \end{matrix}$	$\begin{matrix} \text{mm} \\ \text{mm} \end{matrix}$	H mm	L mm	i info	Art.-No.	
M6x1.0	2.0	2.5	8	12	8	1	F1160.06.025	50
M6x1.0	2.5	3.0	8	12	8	1	F1160.06.030	50
M8x1.25	2.5	3.0	11	14	10	1	F1160.08.030	50
M8x1.25	3.0	4.0	11	14	10	1	F1160.08.040	50
M10x1.5	3.0	4.0	13	15	10	1	F1160.10.040	50
M10x1.5	4.0	6.0	13	15	10	1	F1160.10.060	50
M12x1.5	3.5	5.0	15	17	10	-	F1160.12.050	50
M12x1.5	5.0	6.5	15	17	10	-	F1160.12.065	50
M12x1.5	6.5	7.5	15	17	10	-	F1160.12.075	50
M16x1.5	8.0	10.5	18	22	10	-	F1160.17.105	50
M20x1.5	11.0	14.5	24	23	10	-	F1160.20.145	50
M25x1.5	16.0	19.0	30	28	11	-	F1160.25.190	25
M32x1.5	21.0	25.5	36	28	13	-	F1160.32.255	25
M40x1.5	28.5	33.0	46	34	13	-	F1160.40.330	10
M50x1.5	37.0	42.0	55	34	14	-	F1160.50.420	10
M63x1.5	46.0	52.0	70	37	14	-	F1160.63.520	5
M75x1.5	56.0	63.0	80	38	15	-	F1160.75.630	1

1 = Metrisches Regelgewinde

1 = Metric coarse-pitch thread

Auf Anfrage lieferbar:

Available on request:

Anschlussgewinde Pg und NPT

Entry thread Pg and NPT

Zweiteiliger Dichteinsatz  
 Durchgehend isolierend

Two-piece sealing insert  
 overall length insulated

G	$\begin{matrix} > < \\ \text{min mm} \end{matrix}$	$\begin{matrix} > < \\ \text{max mm} \end{matrix}$	$\begin{matrix} > < \\ \text{min mm} \end{matrix}$	$\begin{matrix} > < \\ \text{max mm} \end{matrix}$	$\begin{matrix} \text{mm} \\ \text{mm} \end{matrix}$	H mm	L mm	Art.-No.	
M16x1.5	6.0	8.0	8.0	10.5	18	22	10	F1160.17	50
M20x1.5	8.0	11.0	11.0	14.5	24	23	10	F1160.20	50
M25x1.5	12.5	16.0	16.0	19.0	30	28	11	F1160.25	25
M32x1.5	17.0	21.0	21.0	25.5	36	28	13	F1160.32	25
M40x1.5	24.0	28.5	28.5	33.0	46	31	13	F1160.40	10
M50x1.5	33.0	37.0	37.0	42.0	55	34	14	F1160.50	10
M63x1.5	41.0	46.0	46.0	52.0	70	37	14	F1160.63	5
M75x1.5	50.0	56.0	56.0	63.0	80	38	15	F1160.75	1

Auf Anfrage lieferbar:

Available on request:

Anschlussgewinde Pg und NPT

Entry thread Pg and NPT

# Kabelverschraubungen Progress® nach EN 45545-2/3 und NFPA 130

## Cable glands Progress® according to EN 45545-2/3 and NFPA 130

### Langes Anschlussgewinde metrisch | Long entry thread metric

Material:	Messing vernickelt	Material:	Nickel-plated brass
Dichtung:	Spezial AGRO TPE hellgrau	Seal:	Special AGRO TPE light grey
O-Ring:	NBR	O-ring:	NBR
Zugentlastung:	Ausführung A nach EN 62444	Strain relief:	Version A acc. to EN 62444
Schutzart:	IP 68 (bis 10 bar) / IP 69	Protection class:	IP 68 (up to 10 bar) / IP 69
Einsatztemperatur:	-50 °C / +105 °C	Operation temperature:	-50 °C / +105 °C

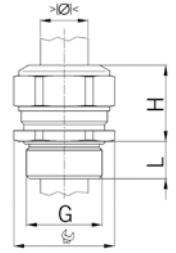

Einteiliger Dichteinsatz  
Nicht durchgehend isolierend

One-piece sealing insert  
not overall length insulated

G	>math>D_1</math> min mm	>math>D_1</math> max mm	 mm	H mm	L mm	i info	Art.-No.	
M6x1.0	2.0	2.5	8	12	8	1	F1100.06.025	50
M6x1.0	2.5	3.0	8	12	8	1	F1100.06.030	50
M6x1.0	3.0	3.5	8	12	8	1	F1100.06.035	50
M8x1.25	2.5	3.5	11	14	10	1	F1100.08.035	50
M8x1.25	3.5	5.0	11	14	10	1	F1100.08.050	50
M10x1.5	3.0	4.0	13	15	10	1	F1100.10.040	50
M10x1.5	4.0	6.0	13	15	10	1	F1100.10.060	50
M12x1.5	3.5	5.0	15	17	10	-	F1100.12.050	50
M12x1.5	5.0	6.5	15	17	10	-	F1100.12.065	50
M12x1.5	6.5	8.0	15	17	10	-	F1100.12.080	50
M16x1.5	3.5	4.5	18	20	10	-	F1100.17.045	50
M16x1.5	4.5	6.0	18	20	10	-	F1100.17.060	50
M16x1.5	6.0	8.0	18	20	10	-	F1100.17.080	50
M16x1.5	8.0	10.5	18	22	10	-	F1100.17.105	50
M20x1.5	6.0	8.0	24	21	10	-	F1100.20.080	50
M20x1.5	8.0	11.0	24	21	10	-	F1100.20.110	50
M20x1.5	11.0	15.0	24	23	10	-	F1100.20.150	50
M25x1.5	9.5	12.5	30	25	11	-	F1100.25.125	25
M25x1.5	12.5	16.0	30	27	11	-	F1100.25.160	25
M25x1.5	16.0	20.5	30	28	11	-	F1100.25.205	25
M32x1.5	14.0	17.0	36	28	13	-	F1100.32.170	25
M32x1.5	17.0	21.0	36	28	13	-	F1100.32.210	25
M32x1.5	21.0	25.5	36	28	13	-	F1100.32.255	25
M40x1.5	20.0	24.0	46	31	13	-	F1100.40.240	10
M40x1.5	24.0	28.5	46	31	13	-	F1100.40.285	10
M40x1.5	28.5	33.0	46	31	13	-	F1100.40.330	10
M50x1.5	29.0	33.0	55	34	14	-	F1100.50.330	10
M50x1.5	33.0	37.0	55	34	14	-	F1100.50.370	10
M50x1.5	37.0	42.0	55	34	14	-	F1100.50.420	10
M63x1.5	35.0	40.0	70	37	14	-	F1100.63.400	5
M63x1.5	40.0	46.0	70	37	14	-	F1100.63.460	5
M63x1.5	46.0	52.0	70	37	14	-	F1100.63.520	5
M75x1.5	45.0	50.0	80	38	15	-	F1100.75.500	1
M75x1.5	50.0	56.0	80	38	15	-	F1100.75.560	1
M75x1.5	56.0	63.0	80	38	15	-	F1100.75.630	1



1 = Metrisches Regelgewinde

1 = Metric coarse-pitch thread

Auf Anfrage lieferbar:

Available on request:

Anschlussgewinde Pg und NPT

Entry thread Pg and NPT

# Kabelverschraubungen Progress® nach EN 45545-2/3 und NFPA 130

## Cable glands Progress® according to EN 45545-2/3 and NFPA 130

### Langes Anschlussgewinde metrisch | Long entry thread metric

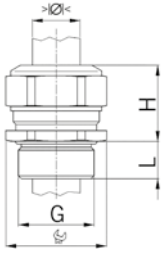

Material: Messing vernickelt  
 Dichtung: Spezial AGRO TPE hellgrau  
 O-Ring: NBR  
 Zugentlastung: Ausführung A nach EN 62444  
 Schutzart: IP 68 (bis 10 bar) / IP 69  
 Einsatztemperatur: -50 °C / +105 °C

Material: Nickel-plated brass  
 Seal: Special AGRO TPE light grey  
 O-ring: NBR  
 Strain relief: Version A acc. to EN 62444  
 Protection class: IP 68 (up to 10 bar) / IP 69  
 Operation temperature: -50 °C / +105 °C



Zweiteiliger Dichteinsatz  
 Nicht durchgehend isolierend

Two-piece sealing insert  
 not overall length insulated

G	> Ø < min mm	> Ø < max mm	> Ø < min mm	> Ø < max mm	mm	H mm	L mm	Art.-No.	
<b>M16x1.5</b>	6.0	8.0	8.0	10.5	18	22	10	<b>F1100.17</b>	50
<b>M20x1.5</b>	8.0	11.0	11.0	15.0	24	23	10	<b>F1100.20</b>	50
<b>M25x1.5</b>	12.5	16.0	16.0	20.5	30	28	11	<b>F1100.25</b>	25
<b>M32x1.5</b>	17.0	21.0	21.0	25.5	36	28	13	<b>F1100.32</b>	25
<b>M40x1.5</b>	24.0	28.5	28.5	33.0	46	31	13	<b>F1100.40</b>	10
<b>M50x1.5</b>	33.0	37.0	37.0	42.0	55	34	14	<b>F1100.50</b>	10
<b>M63x1.5</b>	40.0	46.0	46.0	52.0	70	37	14	<b>F1100.63</b>	5
<b>M75x1.5</b>	50.0	56.0	56.0	63.0	80	38	15	<b>F1100.75</b>	1

Auf Anfrage lieferbar:  
 Anschlussgewinde Pg und NPT  
 Rostfreier Stahl A2 oder A4

Available on request:  
 Entry thread Pg and NPT  
 Stainless steel A2 or A4

EN 45545-2  
 HL 3

EN 45545-3  
 E30



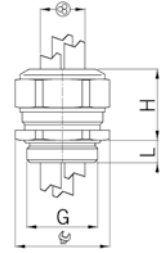

**Kurzes Anschlussgewinde metrisch | Short entry thread metric**

Material:	Messing vernickelt	Material:	Nickel-plated brass
Dichtung:	Spezial AGRO TPE hellgrau	Seal:	Special AGRO TPE light grey
O-Ring:	NBR	O-ring:	NBR
Zugentlastung:	Ausführung A nach EN 62444	Strain relief:	Version A acc. to EN 62444
Schutzart:	IP 68	Protection class:	IP 68
Einsatztemperatur:	-50 °C / +105 °C	Operation temperature:	-50 °C / +105 °C



Einteiliger Dichteinsatz  
Nicht durchgehend isolierend

One-piece sealing insert  
not overall length insulated

G	$\begin{matrix} > \ominus < \\ \text{min mm} \end{matrix}$	$\begin{matrix} > \ominus < \\ \text{max mm} \end{matrix}$			H mm	L mm	Art.-No.	
M16x1.5	2.0	3.0	2	18	22	5	F1310.17.2.030	50
M16x1.5	2.5	4.0	2	18	22	5	F1310.17.2.040	50
M16x1.5	3.5	5.0	2	18	22	5	F1310.17.2.050	50
M20x1.5	3.5	5.0	2	24	23	6	F1310.20.2.050	50
M20x1.5	4.5	6.0	2	24	23	6	F1310.20.2.060	50
M20x1.5	5.5	7.5	2	24	23	6	F1310.20.2.075	50
M20x1.5	3.5	5.0	3	24	23	6	F1310.20.3.050	50
M20x1.5	4.5	6.0	3	24	23	6	F1310.20.3.060	50
M20x1.5	5.2	6.5	3	24	23	6	F1310.20.3.065	50
M20x1.5	3.5	5.0	4	24	23	6	F1310.20.4.050	50
M20x1.5	4.5	6.0	4	24	23	6	F1310.20.4.060	50
M25x1.5	5.0	7.0	2	30	28	7	F1310.25.2.070	25
M25x1.5	6.7	9.0	2	30	28	7	F1310.25.2.090	25
M25x1.5	7.7	10.0	2	30	28	7	F1310.25.2.100	25
M25x1.5	5.5	7.0	3	30	28	7	F1310.25.3.070	25
M25x1.5	6.8	9.0	3	30	28	7	F1310.25.3.090	25
M25x1.5	5.5	7.0	4	30	28	7	F1310.25.4.070	25
M25x1.5	4.8	6.0	6	30	28	7	F1310.25.6.060	25
M32x1.5	9.0	11.5	2	36	28	8	F1310.32.2.115	25
M32x1.5	7.0	9.0	3	36	28	8	F1310.32.3.090	25
M32x1.5	8.5	10.5	3	36	28	8	F1310.32.3.105	25
M32x1.5	7.0	9.0	4	36	28	8	F1310.32.4.090	25
M32x1.5	5.8	7.0	6	36	28	8	F1310.32.6.070	25



Weitere Ausführungen und Anschlussgewinde auf Anfrage

Further versions and entry threads are available upon request.

Langes Anschlussgewinde metrisch | Long entry thread metric

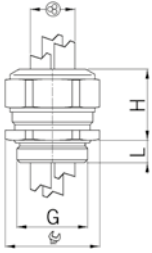

Material: Messing vernickelt  
 Dichtung: Spezial AGRO TPE hellgrau  
 O-Ring: NBR  
 Zugentlastung: Ausführung A nach EN 62444  
 Schutzart: IP 68  
 Einsatztemperatur: -50 °C / +105 °C

Material: Nickel-plated brass  
 Seal: Special AGRO TPE light grey  
 O-ring: NBR  
 Strain relief: Version A acc. to EN 62444  
 Protection class: IP 68  
 Operation temperature: -50 °C / +105 °C



Einteiliger Dichteinsatz  
 Nicht durchgehend isolierend

One-piece sealing insert  
 not overall length insulated

G	> Ø <	> Ø <	⊗	⊗	H	L	Art.-No.	
	min mm	max mm	mm	mm	mm	mm		
M16x1.5	2.0	3.0	2	18	22	10	F1311.17.2.030	50
M16x1.5	2.5	4.0	2	18	22	10	F1311.17.2.040	50
M16x1.5	3.5	5.0	2	18	22	10	F1311.17.2.050	50
M20x1.5	3.5	5.0	2	24	23	10	F1311.20.2.050	50
M20x1.5	4.5	6.0	2	24	23	10	F1311.20.2.060	50
M20x1.5	5.5	7.5	2	24	23	10	F1311.20.2.075	50
M20x1.5	3.5	5.0	3	24	23	10	F1311.20.3.050	50
M20x1.5	4.5	6.0	3	24	23	10	F1311.20.3.060	50
M20x1.5	5.2	6.5	3	24	23	10	F1311.20.3.065	50
M20x1.5	3.5	5.0	4	24	23	10	F1311.20.4.050	50
M20x1.5	4.5	6.0	4	24	23	10	F1311.20.4.060	50
M25x1.5	5.0	7.0	2	30	28	11	F1311.25.2.070	25
M25x1.5	6.7	9.0	2	30	28	11	F1311.25.2.090	25
M25x1.5	7.7	10.0	2	30	28	11	F1311.25.2.100	25
M25x1.5	5.5	7.0	3	30	28	11	F1311.25.3.070	25
M25x1.5	6.8	9.0	3	30	28	11	F1311.25.3.090	25
M25x1.5	5.5	7.0	4	30	28	11	F1311.25.4.070	25
M25x1.5	4.8	6.0	6	30	28	11	F1311.25.6.060	25
M32x1.5	9.0	11.5	2	36	28	13	F1311.32.2.115	25
M32x1.5	7.0	9.0	3	36	28	13	F1311.32.3.090	25
M32x1.5	8.5	10.5	3	36	28	13	F1311.32.3.105	25
M32x1.5	7.0	9.0	4	36	28	13	F1311.32.4.090	25
M32x1.5	5.8	7.0	6	36	28	13	F1311.32.6.070	25

Weitere Ausführungen und Anschlussgewinde auf Anfrage

Further versions and entry threads are available upon request.

### Kurzes Anschlussgewinde metrisch | Short entry thread metric

Material:	Messing vernickelt	Material:	Nickel-plated brass
Knickschutzfeder:	Rostfreier Stahl A2	Antikink spring:	Stainless steel A2
Dichtung:	Spezial AGRO TPE hellgrau	Seal:	Special AGRO TPE light grey
O-Ring:	NBR	O-ring:	NBR
Zugentlastung:	Ausführung A nach EN 62444	Strain relief:	Version A acc. to EN 62444
Schutzart:	IP 68 (bis 10 bar) / IP 69	Protection class:	IP 68 (up to 10 bar) / IP 69
Einsatztemperatur:	-50 °C / +105 °C	Operation temperature:	-50 °C / +105 °C

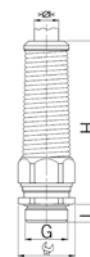

Einteiliger Dichteinsatz  
Durchgehend isolierend

One-piece sealing insert  
overall length insulated

G	> Ø <	> Ø <		H	L	i	Art.-No.	
	min mm	max mm	mm	mm	mm	info		
M8x1.25	2.5	3.0	11	49	5	1	F1060.08.52.030	10
M8x1.25	3.5	4.0	11	49	5	1	F1060.08.52.040	10
M10x1.5	3.0	4.0	13	52	5	1	F1060.10.52.040	10
M10x1.5	4.0	6.0	13	52	5	1	F1060.10.52.060	10
M12x1.5	3.5	5.0	15	57	5	-	F1060.12.52.050	10
M12x1.5	5.0	6.5	15	57	5	-	F1060.12.52.065	10
M12x1.5	6.5	7.5	15	57	5	-	F1060.12.52.075	10
M16x1.5	4.5	6.0	18	66	5	-	F1060.17.52.060	10
M16x1.5	6.0	8.0	18	66	5	-	F1060.17.52.080	10
M16x1.5	8.0	10.5	18	66	5	-	F1060.17.52.105	10
M20x1.5	6.0	8.0	24	86	6	-	F1060.20.52.080	10
M20x1.5	8.0	11.0	24	86	6	-	F1060.20.52.110	10
M20x1.5	11.0	14.5	24	86	6	-	F1060.20.52.145	10
M25x1.5	9.5	12.5	30	99	7	-	F1060.25.52.125	10
M25x1.5	12.5	16.0	30	99	7	-	F1060.25.52.160	10
M25x1.5	16.0	19.0	30	99	7	-	F1060.25.52.190	10
M32x1.5	17.0	21.0	36	109	8	-	F1060.32.52.210	5
M32x1.5	21.0	24.5	36	109	8	-	F1060.32.52.245	5



1 = Metrisches Regelgewinde (mit VDE Testreport)

1 = Metric coarse-pitch thread (with VDE test report)

Auf Anfrage lieferbar:

Available on request:

Kurzes Anschlussgewinde mit kurzem ein- oder zweiteiligem Dichteinsatz.

- Short entry thread with short one-piece or two-piece sealing insert.

Langes Anschlussgewinde mit kurzem oder durchgehend isolierendem ein- oder zweiteiligem Dichteinsatz.

- Long entry thread with short or full-length insulating one-piece or two-piece sealing insert.

### Kurzes Anschlussgewinde metrisch | Short entry thread metric

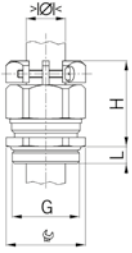

Material: Messing vernickelt  
 Klemmschrauben: Rostfreier Stahl A2  
 Dichtung: Spezial AGRO TPE hellgrau  
 O-Ring: NBR  
 Zugentlastung: Ausführung B nach EN 62444  
 Schutzart: IP 68 (bis 10 bar) / IP 69  
 Einsatztemperatur: -50 °C / +105 °C

Material: Nickel-plated brass  
 Screws: Stainless steel A2  
 Seal: Special AGRO TPE light grey  
 O-ring: NBR  
 Strain relief: Version B acc. to EN 62444  
 Protection class: IP 68 (up to 10 bar) / IP 69  
 Operation temperature: -50 °C / +105 °C



Einteiliger Dichteinsatz  
 Nicht durchgehend isolierend

One-piece sealing insert  
 not overall length insulated

G	>Ø1< min mm	>Ø1< max mm	Ø mm	H mm	L mm	i info	Art.-No.	
M10x1.5	3.0	4.0	13/16	24	5	1	F1800.10.03.040	50
M10x1.5	4.0	6.0	13/16	24	5	1	F1800.10.03.060	50
M12x1.5	5.0	6.5	15/16	26	5	-	F1800.12.03.065	50
M12x1.5	6.5	8.0	15/16	26	5	-	F1800.12.03.080	50

1 = Metrisches Regelgewinde (mit VDE Testreport)

1 = Metric coarse-pitch thread (with VDE test report)

EN 45545-2  
 HL 3

EN 45545-3  
 E30



Zweiteiliger Dichteinsatz  
 Nicht durchgehend isolierend

Two-piece sealing insert  
 not overall length insulated

G	>Ø1< min mm	>Ø1< max mm	>Ø1< min mm	>Ø1< max mm	Ø mm	H mm	L mm	Art.-No.	
M16x1.5	6.0	8.0	8.0	10.5	18/19	30	5	F1800.17.03.105	50
M20x1.5	8.0	11.0	11.0	15.0	24	31	6	F1800.20.03.150	50
M25x1.5	12.5	16.0	16.0	20.5	30	35	7	F1800.25.03.205	25
M32x1.5	17.0	21.0	21.0	25.5	36	40	8	F1800.32.03.255	25
M40x1.5	24.0	28.5	28.5	33	46	44	8	F1800.40.03.330	10
M50x1.5	33.0	37.0	37.0	42.0	55	49	9	F1800.50.03.410	10
M63x1.5	40.0	46.0	46.0	52.0	70	55	10	F1800.63.03.520	5
M75x1.5	50.0	56.0	56.0	63.0	80	56	11	F1800.75.03.630	1

**Kurzes Anschlussgewinde metrisch | Short entry thread metric**

Material:	Messing vernickelt	Material:	Nickel-plated brass
Kontaktfeder:	Federstahl 1.4310	Contact spring:	Spring steel 1.4310
Dichtung:	Spezial AGRO TPE hellgrau	Seal:	Special AGRO TPE light grey
O-Ring:	NBR	O-ring:	NBR
Zugentlastung:	Ausführung A nach EN 62444	Strain relief:	Version A acc. to EN 62444
Schutzart:	IP 68 (bis 10 bar) / IP 69	Protection class:	IP 68 (up to 10 bar) / IP 69
Eigenschaften:	Für zeitsparende und sichere Montage von partiell abisolierten sowie durchgehend geschirmten Kabeln	Properties:	For a quick and safe installation of partially dismantled cables as well as thoroughly shielded cables
Einsatztemperatur:	-50 °C / +105 °C	Operation temperature:	-50 °C / +105 °C



Zweiteiliger Dichteinsatz  
Nicht durchgehend isolierend

Two-piece sealing insert  
not overall length insulated

G	> Ø <	> Ø <	> Ø <	> Ø <	⊕	H	L	i	Art.-No.	
	min mm	max mm	min mm	max mm	mm	mm	mm	info		
M12x1.5	-	-	3.5	5.0	15	22	5	1	F1083.12.050	50
M12x1.5	-	-	5.0	6.5	15	22	5	1	F1083.12.065	50
M16x1.5	6.0	8.0	8.0	10.5	18	25	5	-	F1083.17	50
M20x1.5	8.0	11.0	11.0	15.0	24	27	6	-	F1083.20	50
M25x1.5	12.5	16.0	16.0	20.5	30	33	7	-	F1083.25	25
M32x1.5	17.0	21.0	21.0	25.5	36	33	8	-	F1083.32	25
M40x1.5	24.0	28.5	28.5	33.0	46	38	8	-	F1083.40	10
M50x1.5	33.0	37.0	37.0	42.0	55	42	9	-	F1083.50	10
M63x1.5	40.0	46.0	46.0	52.0	70	42	10	-	F1083.63	5



1 = Einteiliger Dichteinsatz

1 = One-piece sealing insert

Auf Anfrage lieferbar:

Available on request:

Anschlussgewinde Pg und NPT

Entry thread Pg and NPT

Ausführungen in Stahl A2 und A4

Executions in steel A2 and A4

**Langes Anschlussgewinde metrisch | Long entry thread metric**

Zweiteiliger Dichteinsatz  
Nicht durchgehend isolierend

Two-piece sealing insert  
not overall length insulated

G	> Ø <	> Ø <	> Ø <	> Ø <	⊕	H	L	i	Art.-No.	
	min mm	max mm	min mm	max mm	mm	mm	mm	info		
M12x1.5	-	-	3.5	5.0	15	22	10	1	F1183.12.050	50
M12x1.5	-	-	5.0	6.5	15	22	10	1	F1183.12.065	50
M16x1.5	6.0	8.0	8.0	10.5	18	25	10	-	F1183.17	50
M20x1.5	8.0	11.0	11.0	15.0	24	27	10	-	F1183.20	50
M25x1.5	12.5	16.0	16.0	20.5	30	33	11	-	F1183.25	25
M32x1.5	17.0	21.0	21.0	25.5	36	33	13	-	F1183.32	25
M40x1.5	24.0	28.5	28.5	33.0	46	38	13	-	F1183.40	10
M50x1.5	33.0	37.0	37.0	42.0	55	42	14	-	F1183.50	10
M63x1.5	40.0	46.0	46.0	52.0	70	42	14	-	F1183.63	5



1 = Einteiliger Dichteinsatz

1 = One-piece sealing insert

Auf Anfrage lieferbar:

Available on request:

Anschlussgewinde Pg und NPT

Entry thread Pg and NPT

Ausführungen in Stahl A2 und A4

Executions in steel A2 and A4

**Kurzes Anschlussgewinde metrisch | Short entry thread metric**

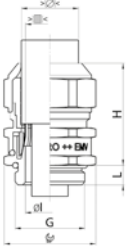

Material: Messing vernickelt  
 Dichtung: Spezial AGRO TPE hellgrau  
 O-Ring: NBR  
 Zugentlastung: Ausführung A nach EN 62444  
 Schutzart: IP 68 (bis 10 bar) / IP 69  
 Eigenschaften: Für hohe Ableitströme, konzentrische Schirmkontaktierung 360° mit tiefstem Übergangswiderstand und Transferimpedanz. Sehr geringe Bauhöhe.  
 Einsatztemperatur: -50 °C / +105 °C

Material: Nickel-plated brass  
 Seal: Special AGRO TPE light grey  
 O-ring: NBR  
 Strain relief: Version A acc. to EN 62444  
 Protection class: IP 68 (up to 10 bar) / IP 69  
 Properties: For high leakage currents, concentric 360° shield contact ensure extremely low transfer resistance and transfer impedance. Compact design  
 Operation temperature: -50 °C / +105 °C



Zweiteiliger Dichteinsatz  
 Nicht durchgehend isolierend

Two-piece sealing insert  
 not overall length insulated

G	> Ø < min mm	> Ø < max mm	> Ø < min mm	> Ø < max mm	> ■ < mm	Ø mm	⌀ mm	H mm	L mm	i info	Art.-No.	
M16x1.5	6.0	8.0	8.0	10.5	9.3	8.2	18	28	5	-	F1084.17	25
M20x1.5	8.0	11.0	11.0	15.0	13.4	11.9	24	32	6	-	F1084.20	25
M25x1.5	12.5	16.0	16.0	20.5	18.7	17.6	30	36.5	7	-	F1084.25	25
M32x1.5	17.0	21.0	21.0	25.5	23.8	22.1	36	38.5	8	-	F1084.32	25
M40x1.5	24.0	28.5	28.5	33.0	30.4	29.5	46	42	8	-	F1084.40	10
M50x1.5	33.0	37.0	37.0	42.0	38.7	37.7	55	44.5	9	-	F1084.50	10
M63x1.5	40.0	46.0	46.0	52.0	48.6	46.6	70	49	10	-	F1084.63	5
M75x1.5	50.0	56.0	56.0	63.0	59.7	57.9	80	51	11	-	F1084.75	1
M80x2.0	-	-	58.0	65.0	62.0	59.8	95	58	12	1	F1084.80.650	1
M85x2.0	-	-	63.0	70.0	67.0	64.7	95	58	12	1	F1084.85.700	1

1 = Einteiliger Dichteinsatz

1 = One-piece sealing insert

Auf Anfrage lieferbar:

Available on request:

Rostfreier Stahl A2 oder A4

Stainless steel A2 or A4

Anschlussgewinde Pg und NPT

Entry thread Pg and NPT

**Langes Anschlussgewinde metrisch | Long entry thread metric**



Zweiteiliger Dichteinsatz  
 Nicht durchgehend isolierend

Two-piece sealing insert  
 not overall length insulated

G	> Ø < min mm	> Ø < max mm	> Ø < min mm	> Ø < max mm	> ■ < mm	Ø mm	⌀ mm	H mm	L mm	i info	Art.-No.	
M16x1.5	6.0	8.0	8.0	10.5	9.3	8.2	18	28	10	-	F1184.17	25
M20x1.5	8.0	11.0	11.0	15.0	13.4	11.9	24	32	10	-	F1184.20	25
M25x1.5	12.5	16.0	16.0	20.5	18.7	17.6	30	36.5	11	-	F1184.25	25
M32x1.5	17.0	21.0	21.0	25.5	23.8	22.1	36	38.5	13	-	F1184.32	25
M40x1.5	24.0	28.5	28.5	33.0	30.4	29.5	46	42	13	-	F1184.40	10
M50x1.5	33.0	37.0	37.0	42.0	38.7	37.7	55	44.5	14	-	F1184.50	10
M63x1.5	40.0	46.0	46.0	52.0	48.6	46.6	70	49	14	-	F1184.63	5
M75x1.5	50.0	56.0	56.0	63.0	59.7	57.9	80	51	15	-	F1184.75	1
M80x2.0	-	-	58.0	65.0	62.0	59.8	95	58	18	1	F1184.80.650	1
M85x2.0	-	-	63.0	70.0	67.0	64.7	95	58	18	1	F1184.85.700	1

1 = Einteiliger Dichteinsatz

1 = One-piece sealing insert

Auf Anfrage lieferbar:

Available on request:

Rostfreier Stahl A2 oder A4

Stainless steel A2 or A4

Anschlussgewinde Pg und NPT

Entry thread Pg and NPT

Anschlussgewinde metrisch | Entry thread metric

Material:	Messing vernickelt	Material:	Nickel-plated brass
Dichtung:	Spezial AGRO TPE hellgrau	Seal:	Special AGRO TPE light grey
O-Ring:	NBR	O-ring:	NBR
Zugentlastung:	Ausführung A nach EN 62444	Strain relief:	Version A acc. to EN 62444
Schutzart:	IP 68 (bis 10 bar) / IP 69	Protection class:	IP 68 (up to 10 bar) / IP 69
Eigenschaften:	Für hohe Ableitströme, konzentrische Schirmkontaktierung mit tiefsten Übergangswiderständen und Transferimpedanzen	Properties:	For high leakage currents, concentric shield contact with minimal transfer resistances and transfer impedances
Einsatztemperatur:	-50 °C / +105 °C	Operation temperature:	-50 °C / +105 °C

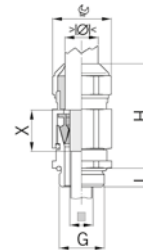

Zweiteiliger Dichteinsatz Nicht durchgehend isolierend						Two-piece sealing insert not overall length insulated						
G	>Ø< min mm	>Ø< max mm	>Ø< min mm	>Ø< max mm	>■< mm	H mm	L mm	X mm	Art.-No.			
M16x1.5	-	-	4.5	6.0	3.0-4.5	18	40	6	F1000.17.85.045	25		
M16x1.5	6.0	8.0	8.0	10.5	4.5-8.0	18	42	8	F1000.17.85.080	25		
M16x1.5	8.0	11.0	11.0	15.0	7.5-10.0	24	47	8	F1000.17.85.100	25		
M20x1.5	8.0	11.0	11.0	15.0	7.5-12.0	24	47	8	F1000.20.85.120	25		
M20x1.5	12.5	16.0	16.0	20.5	10.0-14.0	30	59	8	F1000.20.85.140	20		
M25x1.5	12.5	16.0	16.0	20.5	10.0-16.0	30	59	8	F1000.25.85.160	20		
M25x1.5	17.0	21.0	21.0	25.5	14.0-19.0	36	66	8	F1000.25.85.190	25		
M32x1.5	17.0	21.0	21.0	25.5	14.0-22.0	36	66	10	F1000.32.85.220	25		
M32x1.5	24.0	28.5	28.5	33.0	21.0-25.0	46	68	10	F1000.32.85.250	5		
M40x1.5	24.0	28.5	28.5	33.0	21.0-30.0	46	68	12	F1000.40.85.300	5		
M50x1.5	33.0	37.0	37.0	42.0	29.0-38.0	55	82	13	F1000.50.85.380	5		
M63x1.5	33.0	37.0	37.0	42.0	29.0-38.0	70/55	82	15	F1000.63.85.380	5		
M63x1.5	40.0	46.0	46.0	52.0	35.0-44.0	70	78	15	F1000.63.85.440	1		



Wichtig: Um den Kabelschirm und die Kabellitzen optimal zu schützen ist es erforderlich, das der Kabelverschraubung beiliegende Kupfer-EMV-Tape zu montieren.  
 Important: To provide the best possible protection for the cable shield and the cable, it is necessary to install a copper EMC tape.

Das Kupfer-Tape muss zwingend gemäss Illustration montiert werden! (Beispiel: Tape Scotch 3M Typ 1181)  
 The copper tape must be fixed according to the illustration! (example: Tape Scotch 3M Typ 1181)

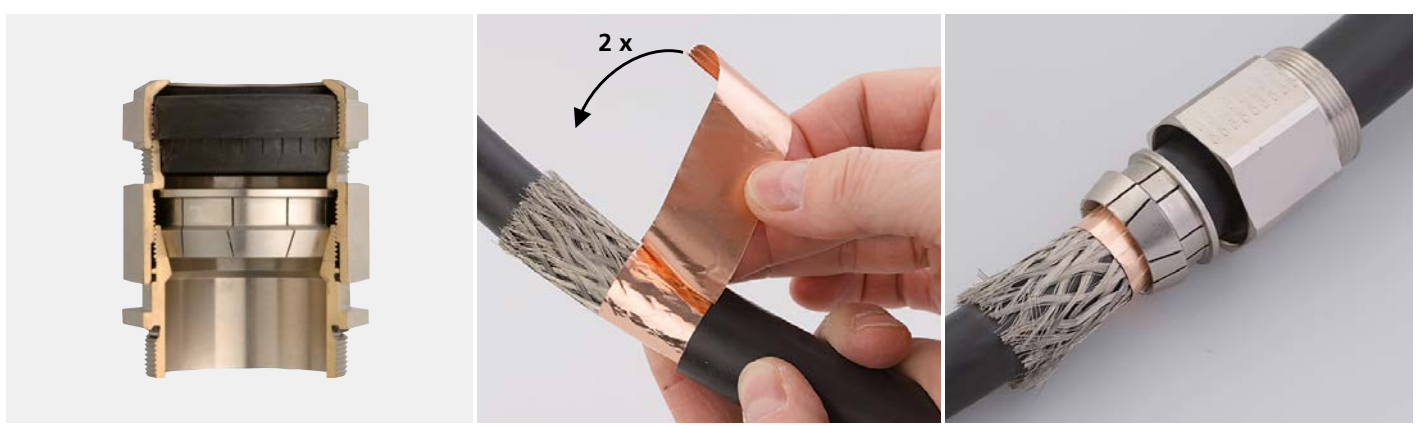

# Ex Kabelverschraubungen

## Ex cable glands

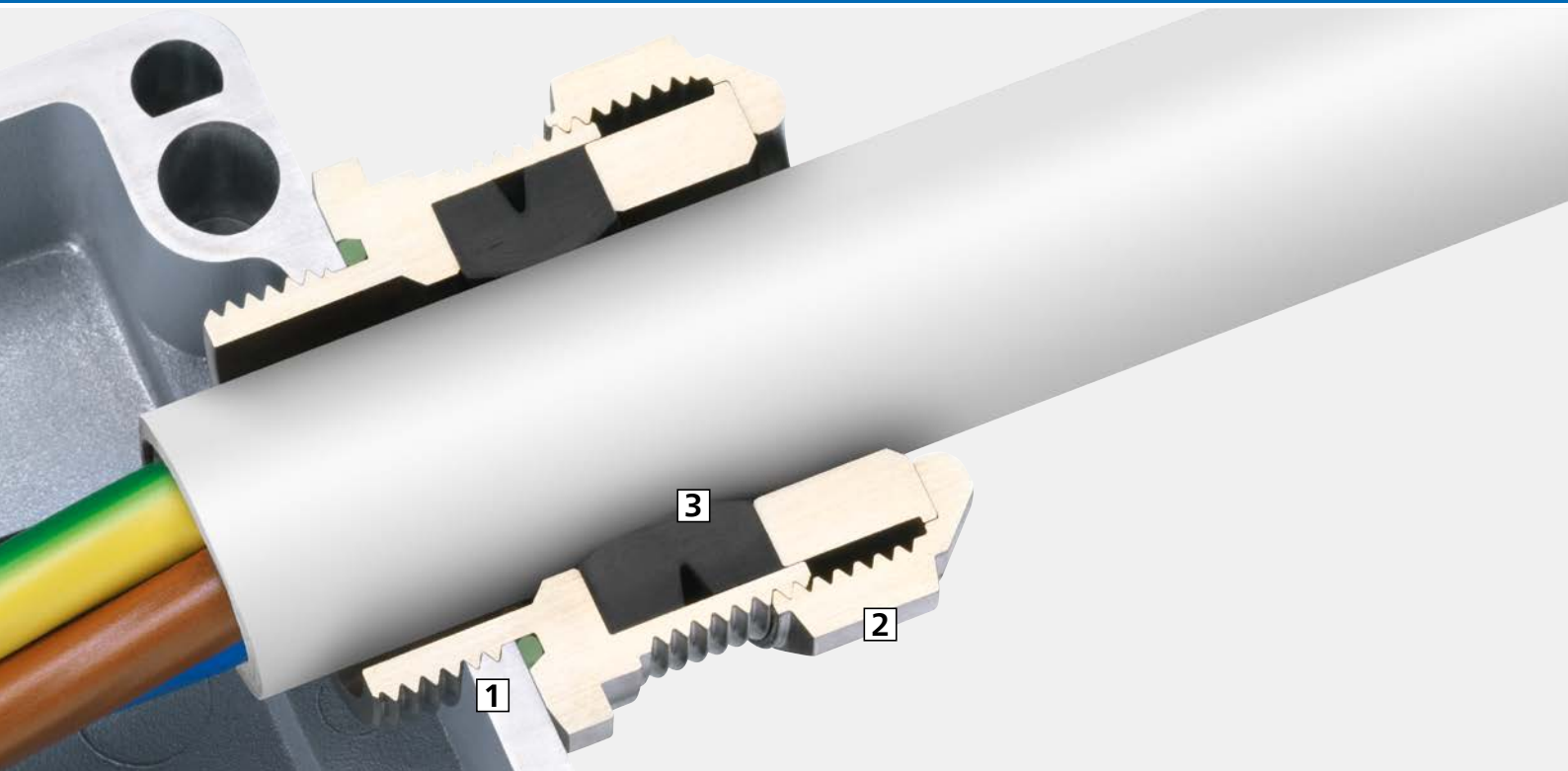

In vielen Bereichen wie zum Beispiel der Chemischen Industrie, Lackierereien, Offshore, Raffinerien, Tankstellen, Textil- und Papierindustrie, Nahrungsmittelindustrie, Glas- und/oder Keramikindustrie, Holzverarbeitung und in vielen weiteren Industrien, werden Geräte in explosionsgefährdeten Bereichen betrieben. Aufgrund der hohen Gefährdung von Personen sowie Sachwerten im Falle einer Explosion gelten speziell in explosionsgefährdeten Bereichen besonders strenge rechtliche und technische Anforderungen. AGRO Ex-Kabelverschraubungen aus Messing oder Kunststoff erfüllen die strengsten Anforderungen und sorgen in explosionsgefährdeten Bereichen für eine sichere Kabeleinführung. Alle Kabelverschraubungen sind zertifiziert und haben eine entsprechende EU-Baumusterprüfbescheinigung. Durch die IECEx-Zertifizierung ist ein weltweiter Einsatz möglich.

### 1 Kurze, lange oder Spezial-Anschlussgewinde

Ex Kabelverschraubungen Progress® mit kurzem oder langem Anschlussgewinde in metrischer, Pg-, Gasrohr- oder NPT-Ausführung können bei vorhandenem Gewinde oder Durchgangsbohrung mit Gegenmutter verwendet werden.

### 2 Stabile Schlüsselflächen

Grosse, stabile Schlüsselflächen an der Druckmutter vereinfachen das Anziehen mit dem Montagewerkzeug.

### 3 Garantierte Dichtigkeit

Auf den Dichteinsatz abgestimmte Innenkonturen sorgen für eine zielgerichtete Verformung des Dichteinsatzes und garantieren somit dessen perfekte Abdichtung. Die Schutzarten IP 68 bis 10 bar (druckfeste Kapselung 30 bar) sowie IP 69 ermöglichen eine breite Anwendung.

In many areas such as the chemical industry, paint shops, the offshore industry, refineries, petrol stations, the textile and paper industry, the food industry, the glass and/or ceramics industry, wood processing and many other industries, equipment is operated in explosive areas. Due to the high risk to persons and property in case of an explosion, very strict legal and technical requirements apply to explosive areas in particular. AGRO Ex cable glands made of brass or plastic comply with the strictest requirements and ensure safe cable entry in explosive areas. All cable glands are certified accordingly and come with an EC type-examination certificate. IECEx certification allows for worldwide use.

### 1 Short, long or special entry thread

Ex Cable glands Progress® with short or long entry thread designed as metric, Pg, gas-pipe or NPT can be used with existing opening threads or with a counter nut.







### 2 Stable spanner flats

Large, stable spanner flats on the nut simplify tightening using the assembly tool.

### 3 Reliable leak-tightness

Inner contours matched to the sealing insert ensure a targeted deformation of the insert and thus ensure its leak-tightness in compliance with protection class IP 68 up to 10 bar (flameproof enclosures up to 30 bar) and IP 69 for a wide range of applications.



AGRO Ex Kabelverschraubungen Messing druckfeste Kapselung Ex d IIC AGRO Ex cable glands nickel-plated brass for flameproof enclosure Ex d IIC		<b>157-158</b>	1
AGRO Kabelverschraubungen Ex Compact Messing druckfeste Kapselung Ex d IIC und erhöhte Sicherheit Ex e II AGRO cable glands Ex Compact nickel-plated brass flameproof enclosure Ex d IIC and increased safety Ex e II		<b>159</b>	2
AGRO Kabelverschraubungen Ex Compact Messing mit Klemmbacken Ex d IIC und Ex e II AGRO cable glands Ex Compact nickel-plated brass with clamps Ex d IIC and Ex e II		<b>160</b>	3
AGRO Kabelverschraubungen Ex Compact Messing druckfeste Kapselung Ex d IIC und erhöhte Sicherheit Ex e II AGRO cable glands Ex Compact nickel-plated brass flameproof enclosure Ex d IIC and increased safety Ex e II		<b>161</b>	3
Verschlusschrauben Messing druckfeste Kapselung Ex d IIC Locking plugs nickel-plated brass flameproof enclosure Ex d IIC		<b>162</b>	4
AGRO Kabelverschraubungen Progress® Messing erhöhte Sicherheit Ex e II AGRO cable glands Progress® nickel-plated brass increased safety Ex e II		<b>163 - 166</b>	5
AGRO Kabelverschraubungen Progress® Messing erhöhte Sicherheit Ex e II für mehrere Kabel AGRO cable glands Progress® nickel-plated brass increased safety Ex e II for installation of multiple cables		<b>167 - 168</b>	6
AGRO Kabelverschraubungen Progress® Messing mit Klemmbacken erhöhte Sicherheit Ex e II AGRO cable glands Progress® nickel-plated brass with clamps increased safety Ex e II		<b>169 - 170</b>	6
AGRO Kabelverschraubungen Progress® Messing mit Trompete und Klemmbacken erhöhte Sicherheit Ex e II AGRO cable glands Progress® nickel-plated brass with trumpet and clamps increased safety Ex e II		<b>171 - 172</b>	7
AGRO Kabelverschraubungen Progress® EMV Rapid Messing mit Kontaktscheibe erhöhte Sicherheit Ex e II AGRO cable glands Progress® EMC Rapid nickel-plated brass with contact disc increased safety EX e II		<b>173</b>	8
AGRO Kabelverschraubungen Progress® EMV Messing mit Kontakthülse erhöhte Sicherheit Ex e II AGRO EMC cable glands Progress® nickel-plated brass with contact sleeve increased safety Ex e II		<b>174 - 175</b>	9
AGRO Kabelverschraubungen Progress® EMV Messing mit Kontakthülse und Klemmbacken erhöhte Sicherheit Ex e II AGRO EMC cable glands Progress® nickel-plated brass with contact sleeve and clamps increased safety Ex e II		<b>176 - 177</b>	9
AGRO Kabelverschraubungen Progress® EMV easyCONNECT mit Klemmbacken erhöhte Sicherheit Ex e II AGRO cable glands Progress® EMC easyCONNECT with clamps increased safety Ex e II		<b>178</b>	10
AGRO Kombi-Schlauchverschraubungen Progress® Messing erhöhte Sicherheit Ex e II AGRO combination conduit glands Progress® nickel-plated brass increased safety Ex e II		<b>179</b>	11
Druckausgleichselement mit Membrane erhöhte Sicherheit Ex e II und Verschlussbolzen Messing vernickelt Pressure balance element with membrane increased safety Ex e II and locking pins nickel-plated brass		<b>180</b>	11
AGRO Kabelverschraubungen Progress® Kunststoff GFK erhöhte Sicherheit Ex e II AGRO synthetic cable glands Progress® GFK increased safety Ex e II		<b>181 - 184</b>	12
AGRO Kabelverschraubungen Progress® Kunststoff GFK erhöhte Sicherheit Ex e II für mehrere Kabel AGRO synthetic cable glands Progress® GFK for increased safety Ex e II with sealing insert for multiple cables		<b>185 - 187</b>	13
AGRO Kabelverschraubungen Progress® Kunststoff GFK erhöhte Sicherheit Ex e II und Eigensicherheit Ex i II AGRO synthetic cable glands Progress® GFK increased safety Ex e II and intrinsic safety Ex i II		<b>188 - 189</b>	14
Reduktionen, Erweiterungen und Verschlusschrauben erhöhte Sicherheit Ex e II Reduction fittings, enlarging fittings and locking plugs increased safety Ex e II		<b>190 - 195</b>	14

1  
2  
3  
4  
5  
6  
7  
8  
9  
10  
11  
12  
13  
14  
15

### Richtlinien & Vorschriften

#### Richtlinie 2014/34/EU

Die Richtlinie 2014/34/EU des Europäischen Parlamentes und des Rates vom 26. Februar 2014 zur Harmonisierung der Rechtsvorschriften dient als Basis, welche für Hersteller und Benutzer von Geräten oder Schutzsystemen für den Einsatz in explosionsgefährdeten Bereichen verbindlich ist.

Seit dem 20.04.2016 dürfen nur noch Produkte gemäss den neuen Richtlinien und entsprechender EU-Konformitätserklärung auf den Markt gebracht werden. Zertifikate nach Richtlinie 94/9/EG behalten ihre Gültigkeit. Eine Neuzertifizierung nach den aktuellen Richtlinien 2014/34/EU ist nicht erforderlich.

Die Richtlinie 2014/34/EU definiert im Anhang verschiedene Module für die Inverkehrbringung von Geräten für den Einsatz in explosionsgefährdeten Bereichen. Oft verwendet, so auch bei AGRO, werden die Module B (Anhang III) und D (Anhang IV), woraus folgende Zertifikate resultieren:

- Die EU-Baumusterprüfbescheinigung
- Die Anerkennung Qualitätssicherung Produktion

Beide Zertifikate werden von akkreditierten Prüfstellen nach erfolgreich absolvierten Prüfungen/Audits ausgestellt.

#### EU-Baumusterprüfbescheinigung

Modul B regelt die EU-Baumusterprüfung. Darauf basiert die EU-Baumusterprüfbescheinigung. Sie wird auf Grund der erfolgreichen technischen Produkteprüfungen ausgestellt.

#### Anerkennung Qualitätssicherung Produktion

Modul D fordert die geprüfte und überwachte Produktion. Sie stellt sicher, dass die in Verkehr gebrachten Produkte mit den Prüfmustern der EU-Baumusterprüfbescheinigung übereinstimmen. Ein vorhandenes QM-System wird nach EN/ISO/IEC 80079-34 geprüft und zertifiziert.

#### EU-Konformitätserklärung

Die EU-Konformitätserklärung basiert auf der EU-Baumusterprüfbescheinigung und der Mitteilung Qualitätssicherung Produktion. Damit erklärt der Hersteller die Einhaltung der geltenden Normen, Richtlinien und Vorschriften. Sichtbar wird dies durch die CE-Kennzeichnung.

### Installation

 **Für das Errichten und Betreiben sind die Vorschriften gemäss IEC / EN 60079-14, das Gerätesicherheitsgesetz, die allgemein anerkannten Regeln der Technik und die Betriebsanleitung massgebend. Damit der geforderte IP-Schutzgrad gemäss EN 60529:2014 erreicht wird, müssen die Verschraubungen sachgerecht im elektrischen Betriebsmittel eingebaut werden.**

Bei Montage von Erweiterungen oder Reduktionen ist darauf zu achten, dass maximal 1 Stk. eingebaut wird. Das Ineinanderschrauben mehrerer Reduktionen / Erweiterungen ist nach Norm nicht zulässig!

Bitte beachten Sie unbedingt unsere Montage-, Betriebs- und Wartungsanleitungen!

Beim Einsatz in Kunststoffgehäuse müssen die Kabelverschraubungen in den Potentialausgleich einbezogen werden. Die auf der Tabelle für die jeweiligen Grössen angegebenen Anzugsdrehmomente für die Druckmutter und die Klemmbackenschrauben sowie die ergänzenden Hinweise sind zu beachten.

### Instandhaltung

 **Die für Wartung, Instandhaltung und Prüfung geltenden Bestimmungen der IEC / EN 60079-14 sind einzuhalten. Im Rahmen der Wartung sind vor allem die für die Zündschutzart massgebenden Teile zu prüfen.**

### Directives & Regulations

#### Directive 2014/34/EU

Directive 2014/34/EU of the European Parliament and Council of 26 February 2014 on the harmonisation of the laws of the Member States serves as a mandatory basis for manufacturers and users of equipment and protective systems for use in potentially explosive atmospheres.

Since 20 April 2016 only products approved according to the new directive and with an EC declaration of conformity can be brought to the market. Old certificates according to the former Directive 94/9/EC remain valid. A recertification according to Directive 2014/34/EU is not necessary.

In the annex of Directive 2014/34/EU, various modules for the commercialisation of equipment intended for use in potentially explosive atmospheres are defined. Modules B (Annex III) and D (Annex IV) are often used, also by AGRO, and from them two certificates result:

- EU type-examination certificate
- Recognition of production quality assurance

Both certificates are issued by accredited testing facilities after tests/audits have been successfully completed.

#### EU type-examination certificate

The EU type-examination certificate is the document which is issued on the basis of successfully passed technical testing according to the requirements of Module B.

#### Recognition of production quality assurance

Module D demands tested and monitored production. It ensures that products placed on the market are identical with the test samples used for the EU type-examination certificate. The quality management system must be tested and certified acc. to EN/ISO/IEC 80079-34.

#### EU declaration of conformity

The EU declaration of conformity is based on the EU type-examination certificate and manufacturing approval. With it, a manufacturer declares that it has observed all applicable standards, instructions and regulations. This is visually indicated by the CE marking.

### Installation

 **The regulations according to IEC / EN 60079-14, the equipment safety law, the generally acknowledged rules of the industry and the operating instructions are applicable for installation and operation. In order to ensure the required IP protection category according to EN 60529:2014 is achieved, the cable glands must be properly installed in the electrical equipment.**

When installing enlarging or reduction fittings, make sure to install one piece only. Standards do not permit the screwing together of reduction / enlarging fittings!

Please note: Our installation, operation and maintenance guidelines must be observed!

When used in enclosures made of plastic, the cable glands must be included in the equipotential bonding system. The tightening torques stated in the table for the respective sizes of compression nuts and clamps and the additional information must be taken into account.

### Maintenance

 **The provisions of IEC / EN 60079-14 which are applicable for service, maintenance and testing must be complied with. During maintenance, in particular the parts critical for the ignition protection category must be examined.**

In Produktions- und Arbeitsstätten können sich Gefahrenbereiche für Explosionen ausbilden, wenn die ersten zwei Voraussetzungen für eine Explosion erfüllt sind. Typische Gefahrenbereiche entstehen in chemischen Fabriken, Raffinerien, Lackfabriken, Lackierereien, Reinigungsanlagen, Mühlen und Lagern für Mahlprodukte, Grossbäckereien und anderen brennbaren Stäuben, in Tank- und Verladeanlagen für brennbare Gase, Flüssigkeiten und Feststoffe.

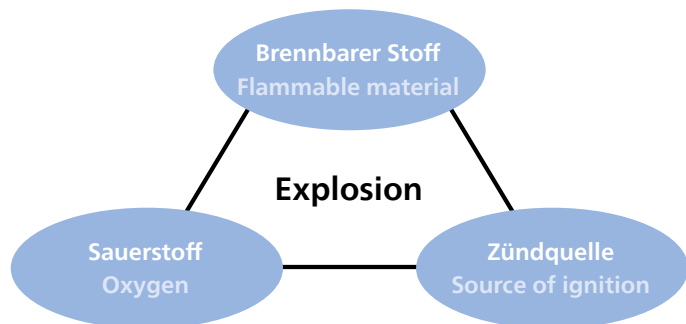

In production and work places, explosive areas may arise when the preconditions for an explosion, as shown in the illustration below, are met. Typical danger zones arise in chemical factories, refineries, paint and varnish factories, paint shops, cleaning plants, mills and storehouses for mill products, large bakeries and other flammable dusts, in tank and loading facilities for inflammable gases, liquids and solid matter.

### Beispiele für Zoneneinteilungen im Ex-Bereich

#### Examples for zone classifications in hazardous (Ex) areas

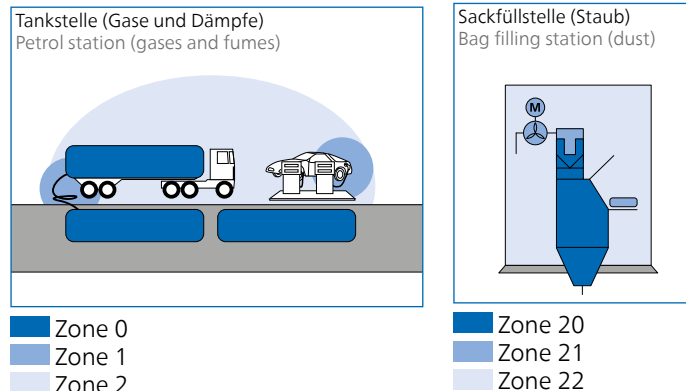

Weiterhin spielt für das Entstehen einer Explosion die Konstellation dieser Faktoren eine Rolle. So kann z.B. eine übersättigte Atmosphäre nicht zünden (Gemisch zu fett) ebenso eine Atmosphäre mit zu hohem Sauerstoffanteil (Gemisch zu mager).

Furthermore, for an explosion to occur, the combination of these factors is important. If the atmosphere is oversaturated (rich mixture) it cannot ignite, nor can it if the oxygen content is too high (lean mixture).

Die Gerätekennzeichnung – unterschieden durch Buchstaben – sagt etwas über die explosionsfähigen Stoffe aus:

The marking of devices, using letters, gives information about the flammable material:

- M** vorangestellt steht für untertägige Bergwerke
- G** nachgestellt steht für brennbare Gase, Nebel oder Dämpfe und
- D** nachgestellt für Stäube

- M** mining
- G** flammable gas, vapour, fumes
- D** dust

Die Ziffern drücken den Grad aus.

Numbers are used to indicate the degree of safety.

- 1** steht für ein sehr hohes Mass an Sicherheit
- 2** steht für ein hohes Mass an Sicherheit
- 3** steht für ein normales Mass an Sicherheit

- 1** very high degree of safety
- 2** high degree of safety
- 3** normal degree of safety

Damit ergibt sich die Zuordnung der Gerätekategorien zu den Zonen.

The outcome of this is the assignment of the device categories to the zones.

Die Definition der Ex-Zonen und der Zusammenhang der explosionsgefährdeten Bereiche mit der Häufigkeit der Zündquellen im Übertagebetrieb.

The definition of the hazardous area and the combination between explosive areas and frequency by sources of ignition (no mining)

Zoneneinteilung / Zoning						
	Gas / Gas			Staub / Dust		
	Zone 0	Zone 1	Zone 2	Zone 20	Zone 21	Zone 22
Häufigkeit der Explosionsgefahr	ständig oder langfristig	gelegentlich	selten und kurzfristig	wie Zone 0 Staubablagerungen allein bilden keine Zone 20	wie Zone 1	wie Zone 2 oder wenn Staubanhäufungen vorhanden sind
Frequency of explosion risk	constant or long-term	occasional	rare and for a short time	Like zone 0 Dust deposits alone are not sufficient for Zone 20 to apply	like Zone 1	like Zone 2 or if dust deposits are present
Häufigkeit der Zündquellen von elektrischen Betriebsmitteln	niemals (auch nicht bei seltenen Betriebsstörungen)	sehr selten (auch nicht bei häufiger zu erwartenden Betriebsstörungen)	gelegentlich (z.B. bei Betriebsstörung)	wie Zone 0	wie Zone 1	wie Zone 2
Frequency of sources of ignition from electrical equipment	never (also not on rare malfunctions)	very rare (also not in the case of more frequently expected malfunctions)	occasional (e.g. during malfunctions)	like Zone 0	like Zone 1	like Zone 2

1  
2  
3  
4  
5  
6  
7  
8  
9  
10  
11  
12  
13  
14  
15

# Generelle Informationen Explosionsschutz

## Information about explosion protection

Gerätezuordnung nach Zonen Device assignment by zones			
Gruppe Group	Stufe Explosionsgefahr Level of explosion risk	Erforderliche Kennzeichnung der einsetzbaren Betriebsmittel Required marking of applicable equipment	
		Gerätegruppe* Device group*	Kategorie Category
Gruppe II Group II	Zone 0	II	1 G
Gruppe II Group II	Zone 1	II	2 G oder / or 1 G
Gruppe II Group II	Zone 2	II	3 G oder / or 2 G
Gruppe III Group III	Zone 20	III	1 D
Gruppe III Group III	Zone 21	III	2 D oder / or 1 D
Gruppe III Group III	Zone 22	III	3 D oder / or 2 D

\* Die Geräte werden in zwei Gruppen unterteilt. Gruppe 1 gilt für schlagwettergefährdete Geräte zur Verwendung im Bergbau und wird hier nicht weiter beschrieben.  
\* The equipment is divided into two groups. Group 1 is applicable to equipment at risk from firedamp and intended for use in mining and will not be described further here.



Für elektrische Betriebsmittel der Gruppe II wird weiter eine Unterteilung in Explosionsgruppen und Temperaturklassen vorgenommen.

For electrical equipment of Group II, further classifications in terms of temperature class and explosion group have been undertaken.

Einteilung in Temperaturklassen Classification by temperature class		
Zündtemperatur in °C Ignition temperature in °C	Temperaturklasse Temperature class	max. Oberflächentemperatur in °C des Betriebsmittels max. surface temperature of the equipment in °C
≥ 450	T1	450
300-450	T2	300
200-300	T3	200
135-200	T4	135
100-135	T5	100
85-100	T6	85



### Einteilung von Explosionsgruppen bei Gas-Ex-Schutz

Brennbare Gase/Dämpfe/Nebel unterscheiden sich in ihrem Zünddurchschlagsvermögen. Daher unterteilt man sie in Explosionsgruppen. Durch Versuchsreihen wurde hierbei die Grenzspaltweite MESG (Maximum Experimental Safe Gap) und der Mindestzündstrom MIC (Minimum Ignition Current) ermittelt. Die Gefährlichkeit der Gase nimmt hierbei von IIA nach IIC zu.



### Classification of explosion groups for gas protection

Flammable gases, fumes and vapours differ in their ignitability. Therefore they are classified in explosion groups. Testing established the MESG (Maximum Experimental Safe Gap) and the MIC (Minimum Ignition Current). The risk increases from IIA to IIC.

Explosionsgruppe Explosion Group	Grenzspaltwerte MESG Maximum experimental safe gap	Mindestzündstromverhältnis bezogen auf Methan Minimum ignition current relating to methane
II A	> 0.9 mm	> 0.8
II B	0.5 mm - 0.9 mm	0.45 - 0.8
II C	< 0.5 mm	< 0.45

Schematische Darstellung der Funktionsprinzipien von einzelnen Zündschutzarten für die AGRO Kabelverschraubungen anbietet.

Schematic representation of functional principle of some ignition protection types for which AGRO offers cable glands.

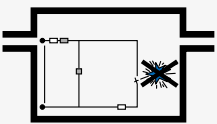
Zündschutzart nach IEC bzw. EN Type of ignition protection according to IEC / EN standards	Grundprinzip Basic principle	Schematische Darstellung Schematic representation
IEC / EN 60079-1	<p>Ex d druckfeste Kapselung</p> <p>Kommt es im Innern eines druckfest gekapselten Gehäuses zu einer Explosion wird eine Übertragung der Explosion nach aussen ausgeschlossen</p> <p>Ex d flameproof enclosures</p> <p>If an explosion occurs within a flameproof enclosure, the explosion will be contained within the enclosure</p>	
IEC / EN 60079-7	<p>Ex e erhöhte Sicherheit</p> <p>Die Entstehung von Funken und hohen Temperaturen wird mit einem erhöhten Grad an Sicherheit ausgeschlossen</p> <p>Ex e increased safety</p> <p>The appearance of sparks and high temperatures is prevented by an increased level of safety.</p>	
IEC / EN 60079-11	<p>Ex i Eigensicherheit</p> <p>Die Energie im Stromkreis wird so gering gehalten, dass zündfähige Funken, Lichtbögen oder hohe Temperaturen nicht entstehen können</p> <p>Ex i intrinsic safety</p> <p>The circuit energy is kept so low that ignitable sparks, electric arcs and high temperatures cannot arise</p>	



### Anwendungen

Die AGRO Kabelverschraubungen für explosionsgeschützte Geräte sind somit für die meisten Anwendungen an explosionsgeschützten Motoren, Schalt- und Steuergeräten, Gehäusen usw. geeignet, die in der Industrie, in der chemischen und petrochemischen Industrie eingesetzt werden.



### Applications

AGRO cable glands for explosion-protected equipment are therefore suitable for most applications in explosion-protected motors, switching and control devices, housings etc. used in industrial fields such as in the machinery and automation industry and in the chemical and petrochemical industry.

	Kabelverschraubung Messing Cable glands nickel-plated brass	Druckfeste Kapselung (Serie 18) Flameproof enclosure (Series 18)	Druckfeste Kapselung (Ex Compact) Progress® Messing (Ex Compact) Standard	Druckfeste Kapselung (Ex Compact) Progress® Messing (Ex Compact) Standard	Für mehrere Kabel For multiple cables	Mit Klemmbacken With clamps	Mit Trompete With trumpet shape and clamps	EMV EMC	Progress® Kunststoff (GFK) Standard	Progress® Kunststoff (GFK / GRP) Standard	Für mehrere Kabel For multiple cables	Zubehör Accessories	Reduktionen Reducers	Erweiterungen Expanders	Adaptern Adapters	Verschraubungen Locking screws
<b>Ausführung / Design</b>																
Kompressionstechnik Compression technology		•	•		•	•	•	•		•	•		-	-	-	-
Zündschutzart Type of protection		d	d/e		e	e	e	e		e/i	e/i		e	e	e	d/e
<b>EMV Technik / EMC technology</b>																
Kontakthülse / Scheibe Contact sleeve / disc		-	-		-	-	-	•		-	-		-	-	-	-
Kontaktfeder Contact spring		-	-		-	-	-	•		-	-		-	-	-	-
<b>Gewinde / Thread</b>																
Anschlussgewinde metrisch Entry thread metric		•	•		•	•	•	•		•	•		-	-	-	•
Anschlussgewinde Pg Entry thread Pg		•	-		•	•	•	•		•	•		-	-	-	•
Anschlussgewinde NPT Entry thread NPT		•	•		-	-	-	-		-	-		-	-	-	-
Anschlussgewinde Gasrohr Entry thread gas-pipe		•	-		-	-	-	-		-	-		-	-	-	-
Aussengewinde metrisch - Innengewinde metrisch External thread metric - internal thread metric		-	-		-	-	-	-		-	-		•	•	-	-
Aussengewinde Pg - Innengewinde metrisch External thread Pg - internal thread metric		-	-		-	-	-	-		-	-		-	-	•	-
Kurzes Anschlussgewinde Short entry thread		-	-		•	•	•	•		•	•		•	•	•	•
Langes Anschlussgewinde Long entry thread		•	•		•	-	-	•		-	-		-	-	-	-
<b>Dichteinsatz / Sealing insert</b>																
Einteiliger Dichteinsatz One-piece sealing insert		•	•		•	•	-	•		•	•		-	-	-	-
Zweiteiliger Dichteinsatz Two-piece sealing insert		-	-		-	-	•	•		-	-		-	-	-	-
Für mehrere Kabel For multiple cables		-	-		-	•	-	-		-	•		-	-	-	-
Standard-Dichteinsatz (TPE / NBR) Standard sealing insert (TPE / NBR)		•	•		•	•	•	•		•	•		-	-	-	-
<b>Technische Besonderheiten / Technical features</b>																
Zugentlastung Strain relief		•	•		•	•	•	•		•	•		-	-	-	-
Mechanische Zugentlastung Mechanical strain relief		•	•		-	-	•	-		-	-		-	-	-	-
Mit Biegeschutz und mechanischer Zugentlastung With bending protection and mechanical strain relief		•	-		-	-	-	•		-	-		-	-	-	-

# AGRO Ex Kabelverschraubungen Messing druckfeste Kapselung Ex d IIC

## AGRO Ex cable glands nickel-plated brass for flameproof enclosure Ex d IIC

### Anschlussgewinde metrisch | Entry thread metric

Material: Messing vernickelt  
 Schrauben: Rostfreier Stahl A2  
 Dichtung: NBR  
 O-Ring: FPM  
 Schutzart: IP 68 (30 bar)  
 Prüfnorm: IEC EN 60079-0 / IEC EN 60079-1 / IEC EN 60079-31  
 Gas: II 2 G Ex db eb IIC Gb  
 Staub: II 2 D Ex ta IIIC Da  
 Zone: Gas 1 und 2 / Staub 21 und 22  
 Zertifikat: PTB 00 ATEX 1059  
 IECEx Zertifikat: IECEx PTB 12.0056  
 Einsatztemperatur: -40 °C / +100 °C

Material: Nickel-plated brass  
 Screws: Stainless steel A2  
 Seal: NBR  
 O-ring: FPM  
 Protection class: IP 68 (30 bar)  
 Test standard: IEC EN 60079-0 / IEC EN 60079-1 / IEC EN 60079-31  
 Gas: II 2 G Ex db eb IIC Gb  
 Dust: II 2 D Ex ta IIIC Da  
 Zone: Gas 1 and 2 / dust 21 and 22  
 Certificate: PTB 00 ATEX 1059  
 IECEx Certificate: IECEx PTB 12.0056  
 Operation temperature: -40 °C / +100 °C

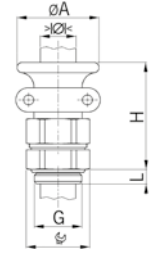

Einteiliger Dichteinsatz Nicht durchgehend isolierend		One-piece sealing insert not overall length insulated					
G	> Ø < min mm	> Ø < max mm	ØA mm	H mm	L mm	Art.-No.	
M16x1.5	7.0	9.0	20	27	57	1817.09.26	20
M20x1.5	9.0	11.0	24	30	57	1820.11.26	20
M20x1.5	11.0	13.0	26	32	57	1820.16.26	20
M25x1.5	13.0	16.5	32	40	67	1825.21.26	10
M25x1.5	16.5	20.0	36	44	67	1825.21.27	10
M32x1.5	20.0	24.0	46	48	78	1832.29.26	5
M40x1.5	24.0	28.0	46	52	78	1840.29.27	5
M50x1.5	28.0	32.0	55	60	85	1850.36.26	5
M50x1.5	32.0	36.0	55	64	85	1850.36.27	5
M63x1.5	36.0	40.0	70	75	88	1863.48.26	1
M63x1.5	40.0	44.0	70	80	88	1863.48.27	1



Serie 18



### Anschlussgewinde Pg | Entry thread Pg

Einteiliger Dichteinsatz Nicht durchgehend isolierend		One-piece sealing insert not overall length insulated					
G	> Ø < min mm	> Ø < max mm	ØA mm	H mm	L mm	Art.-No.	
Pg 9	7.0	9.0	20	27	57	1809.26	20
Pg 11	9.0	11.0	24	30	57	1811.26	20
Pg 13	11.0	13.0	26	32	57	1813.26	20
Pg 16	11.0	13.0	26	32	57	1816.26	20
Pg 21	13.0	16.5	32	40	67	1821.26	10
Pg 21	16.5	20.0	36	44	67	1821.27	10
Pg 29	20.0	24.0	45	48	78	1829.26	5
Pg 29	24.0	28.0	45	52	78	1829.27	5
Pg 36	28.0	32.0	55	60	85	1836.26	5
Pg 36	32.0	36.0	55	64	85	1836.27	5
Pg 48	36.0	40.0	64	75	88	1848.48.26	1
Pg 48	40.0	44.0	64	80	88	1848.48.27	1



Serie 18



# AGRO Ex Kabelverschraubungen Messing druckfeste Kapselung Ex d IIC

## AGRO Ex cable glands nickel-plated brass for flameproof enclosure Ex d IIC

### Anschlussgewinde NPT | Entry thread NPT

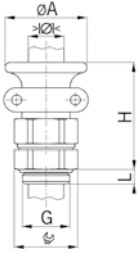

Material: Messing vernickelt  
 Schrauben: Rostfreier Stahl A2  
 Dichtung: NBR  
 Schutzart: IP 68 (30 bar)  
 Prüfnorm: IEC EN 60079-0 / IEC EN 60079-1 / IEC EN 60079-31  
 Gas: II 2 G Ex db eb IIC Gb  
 Staub: II 2 D Ex ta IIIC Da  
 Zone: Gas 1 und 2 / Staub 21 und 22  
 Zertifikat: PTB 00 ATEX 1059  
 IECEx Zertifikat: IECEx PTB 12.0056  
 Einsatztemperatur: -40 °C / +100 °C

Material: Nickel-plated brass  
 Screws: Stainless steel A2  
 Seal: NBR  
 Protection class: IP 68 (30 bar)  
 Test standard: IEC EN 60079-0 / IEC EN 60079-1 / IEC EN 60079-31  
 Gas: II 2 G Ex db eb IIC Gb  
 Dust: II 2 D Ex ta IIIC Da  
 Zone: Gas 1 and 2 / dust 21 and 22  
 Certificate: PTB 00 ATEX 1059  
 IECEx Certificate: IECEx PTB 12.0056  
 Operation temperature: -40 °C / +100 °C



Serie 18



Einteiliger Dichteinsatz  
 Nicht durchgehend isolierend

One-piece sealing insert  
 not overall length insulated

G	> < < min mm	> < < max mm	mm	$\varnothing A$ mm	H mm	L mm	Art.-No.	
NPT 3/8"	7.0	9.0	20	27	57	15.5	183/8NPT.09.26	20
NPT 1/2"	9.0	11.0	24	30	57	20	181/2NPT.11.26	20
NPT 1/2"	11.0	13.0	26	32	57	20	181/2NPT.16.26	20
NPT 3/4"	9.0	11.0	27	30	57	20	183/4NPT.11.26	20
NPT 3/4"	11.0	13.0	26	32	57	20	183/4NPT.16.26	20
NPT 3/4"	13.0	16.5	32	40	67	20	183/4NPT.21.26	10
NPT 1"	13.0	16.5	32/34	40	67	25	181NPT.21.26	10
NPT 1"	16.5	20.0	36	44	67	25	181NPT.21.27	10
NPT 1 1/4"	20.0	24.0	45	48	78	26	1811/4NPT.29.26	5
NPT 1 1/4"	24.0	28.0	45	52	78	26	1811/4NPT.29.27	5
NPT 1 1/2"	28.0	32.0	55	60	85	26	1811/2NPT.36.26	5
NPT 1 1/2"	32.0	36.0	55	64	85	26	1811/2NPT.36.27	5

IP 68, wenn Anschlussgewinde abgedichtet

IP 68, if the entry thread is sealed

### Anschlussgewinde Gasrohr | Gas-pipe entry thread



Serie 18



Einteiliger Dichteinsatz  
 Nicht durchgehend isolierend

One-piece sealing insert  
 not overall length insulated

G	> < < min mm	> < < max mm	mm	$\varnothing A$ mm	H mm	L mm	Art.-No.	
G 3/8"	7.0	9.0	20	27	57	12	183/8G.09.26	20
G 1/2"	9.0	11.0	24	30	57	14	181/2G.11.26	20
G 1/2"	11.0	13.0	26	32	57	14	181/2G.16.26	20
G 3/4"	13.0	16.5	32	40	67	16	183/4G.21.26	10
G 3/4"	16.5	20.0	36	44	67	16	183/4G.21.27	10
G 1"	20.0	24.0	45	48	78	17	181G.29.26	5
G 1 1/4"	24.0	28.0	45	52	78	17	1811/4G.29.27	5
G 1 1/2"	28.0	32.0	55	60	85	17	1811/2G.36.26	5
G 2"	36.0	40.0	64	75	88	20	1848.26	1
G 2"	40.0	44.0	64	80	88	20	1848.27	1

Anschlussgewinde metrisch | Entry thread metric

Material:	Messing vernickelt	Material:	Nickel-plated brass
Dichtung:	NBR	Seal:	NBR
O-Ring:	FPM	O-ring:	FPM
Schutzart:	IP 66 / IP 68 (30 bar)	Protection class:	IP 66 / IP 68 (30 bar)
Prüfnorm:	IEC EN 60079-0 / IEC EN 60079-1 / IEC EN 60079-7 / IEC EN 60079-31	Test standard:	IEC EN 60079-0 / IEC EN 60079-1 / IEC EN 60079-7 / IEC EN 60079-31
Gas:	II 2G Ex db eb IIC Gb	Gas:	II 2G Ex db eb IIC Gb
Staub:	II 2D Ex ta IIIC Da	Dust:	II 2D Ex ta IIIC Da
Zone:	Gas 1 und 2 / Staub 21 und 22	Zone:	Gas 1 and 2 / dust 21 and 22
Zertifikat:	PTB 10 ATEX 1034X	Certificate:	PTB 10 ATEX 1034X
IECEX Zertifikat:	IECEX PTB 12.0055X	IECEX Certificate:	IECEX PTB 12.0055X
Einsatztemperatur:	-60 °C / +105 °C	Operation temperature:	-60 °C / +105 °C

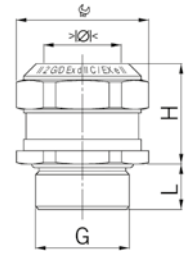

Einteiliger Dichteinsatz Nicht durchgehend isolierend		One-piece sealing insert not overall length insulated				
G	>math>\varnothing</math> min mm	>math>\varnothing</math> max mm	H mm	L mm	Art.-No.	
M16x1.5	3.0	7.0	21	26	EX1126.17.070	25
M16x1.5	5.0	10.0	24	26	EX1126.17.100	25
M20x1.5	5.0	11.0	24	26	EX1126.20.110	25
M20x1.5	9.0	14.0	30	26	EX1126.20.140	25
M25x1.5	7.5	15.0	32	28	EX1126.25.150	20
M25x1.5	12.5	18.0	32	28	EX1126.25.180	20
M32x1.5	17.0	23.0	41	33	EX1126.32.230	10
M32x1.5	21.0	26.0	41	33	EX1126.32.260	10
M40x1.5	21.0	26.0	41	33	EX1126.40.260	10
M40x1.5	24.0	32.0	50	34	EX1126.40.320	10
M50x1.5	28.0	36.0	55	34	EX1126.50.360	5
M50x1.5	35.0	42.0	60	35	EX1126.50.420	5
M63x1.5	36.0	44.0	65	35	EX1126.63.440	1
M63x1.5	43.0	50.0	70	35	EX1126.63.500	1



EX Compact MS



Auf Anfrage lieferbar:  
Rostfreier Stahl A2 oder A4

Available on request:  
Stainless steel A2 or A4

# AGRO Kabelverschraubungen Ex Compact Messing mit Klemmbucken Ex d IIC und Ex e II

## AGRO cable glands Ex Compact nickel-plated brass with clamps Ex d IIC and Ex e II

### Anschlussgewinde metrisch | Entry thread metric

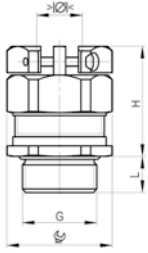

Material: Messing vernickelt  
 Dichtung: NBR  
 O-Ring: FPM  
 Schutzart: IP 66 / IP 68 (30 bar)  
 Prüfnorm: IEC EN 60079-0 / IEC EN 60079-1 / IEC EN 60079-7 / IEC EN 60079-31  
 Gas: II 2G Ex db eb IIC Gb  
 Staub: II 2D Ex tb IIIC Db  
 Zone: Gas 1 und 2 / Staub 21 und 22  
 Zertifikat: SEV 17 ATEX 0153  
 IECEX Zertifikat: IECEX SEV 17.0017  
 Einsatztemperatur: -60 °C / +105 °C

Material: Nickel-plated brass  
 Seal: NBR  
 O-ring: FPM  
 Protection class: IP 66 / IP 68 (30 bar)  
 Test standard: IEC EN 60079-0 / IEC EN 60079-1 / IEC EN 60079-7 / IEC EN 60079-31  
 Gas: II 2G Ex db eb IIC Gb  
 Dust: II 2D Ex tb IIIC Db  
 Zone: Gas 1 and 2 / dust 21 and 22  
 Certificate: SEV 17 ATEX 0153  
 IECEX Certificate: IECEX SEV 17.0017  
 Operation temperature: -60 °C / +105 °C



EX Compact MS KB



Einteiliger Dichteinsatz  
 Nicht durchgehend isolierend

One-piece sealing insert  
 not overall length insulated

G	>math>D</math> min mm	>math>D</math> max mm	H mm	L mm	Art.-No.	
M16x1.5	3.0	7.0	21	34	EX1826.17.070	25
M16x1.5	5.0	10.0	24	35	EX1826.17.100	25
M20x1.5	5.0	11.0	24	35	EX1826.20.110	25
M20x1.5	9.0	14.0	30	35	EX1826.20.140	25
M25x1.5	7.5	15.0	32	37	EX1826.25.150	20
M25x1.5	12.5	18.0	32	37	EX1826.25.180	20
M32x1.5	17.0	23.0	41	42	EX1826.32.230	10
M32x1.5	21.0	26.0	41	42	EX1826.32.260	10
M40x1.5	21.0	26.0	41	42	EX1826.40.260	10
M40x1.5	24.0	32.0	50	47	EX1826.40.320	10
M50x1.5	28.0	36.0	55	48	EX1826.50.360	5
M50x1.5	35.0	42.0	60	50	EX1826.50.420	5
M63x1.5	36.0	44.0	65	51	EX1826.63.440	1
M63x1.5	43.0	50.0	70	51	EX1826.63.500	1

Auf Anfrage lieferbar:  
 Anschlussgewinde Pg und NPT  
 Rostfreier Stahl A2 oder A4

Available on request:  
 Entry thread Pg and NPT  
 Stainless steel A2 or A4

**Anschlussgewinde NPT | Entry thread NPT**

Material: Messing vernickelt  
 Dichtung: NBR  
 Schutzart: IP 66 / IP 68 (30 bar)  
 Prüfnorm: IEC EN 60079-0 / IEC EN 60079-1 / IEC EN 60079-7 / IEC EN 60079-31  
 Gas: II 2G Ex db eb IIC Gb  
 Staub: II 2D Ex ta IIIC Da  
 Zone: Gas 1 und 2 / Staub 21 und 22  
 Zertifikat: PTB 10 ATEX 1034X  
 IECEx Zertifikat: IECEx PTB 12.0055X  
 Einsatztemperatur: -60 °C / +105 °C

Material: Nickel-plated brass  
 Seal: NBR  
 Protection class: IP 66 / IP 68 (30 bar)  
 Test standard: IEC EN 60079-0 / IEC EN 60079-1 / IEC EN 60079-7 / IEC EN 60079-31  
 Gas: II 2G Ex db eb IIC Gb  
 Dust: II 2D Ex ta IIIC Da  
 Zone: Gas 1 and 2 / dust 21 and 22  
 Certificate: PTB 10 ATEX 1034X  
 IECEx Certificate: IECEx PTB 12.0055X  
 Operation temperature: -60 °C / +105 °C

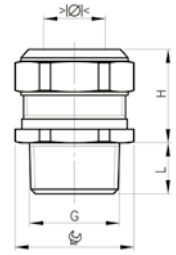

Einteiliger Dichteinsatz  
 Nicht durchgehend isolierend

One-piece sealing insert  
 not overall length insulated

G	>math>\varnothing</math> min mm	>math>\varnothing</math> max mm	H mm	L mm	Art.-No.	
NPT 3/8"	3.0	7.0	21	26	EX1126.3/8NPT.070	25
NPT 3/8"	5.0	10.0	24	26	EX1126.3/8NPT.100	25
NPT 1/2"	5.0	11.0	24	26	EX1126.1/2NPT.110	25
NPT 1/2"	9.0	14.0	30	26	EX1126.1/2NPT.140	25
NPT 3/4"	7.5	15.0	32	28	EX1126.3/4NPT.150	20
NPT 3/4"	12.5	18.0	32	28	EX1126.3/4NPT.180	20
NPT 1"	17.0	23.0	41	33	EX1126.1NPT.230	10
NPT 1"	21.0	26.0	41	33	EX1126.1NPT.260	10
NPT 1 1/4"	24.0	32.0	50	34	EX1126.11/4NPT.320	10
NPT 1 1/2"	28.0	36.0	55	34	EX1126.11/2NPT.360	5
NPT 2"	36.0	44.0	65	35	EX1126.2NPT.440	5

Auf Anfrage lieferbar:  
 Rostfreier Stahl A2 oder A4

Available on request:  
 Stainless steel A2 or A4



EX Compact MS



# Verschlusschrauben Messing druckfeste Kapselung Ex d IIC

## Locking plugs nickel-plated brass flameproof enclosure Ex d IIC

### Anschlussgewinde metrisch | Entry thread metric

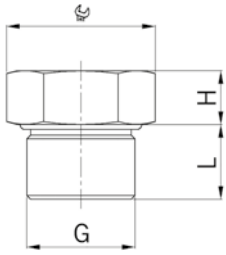

Material: Messing vernickelt  
 O-Ring: FPM  
 Schutzart: IP 68 (30 bar)  
 Prüfnorm: IEC EN 60079-0 / IEC EN 60079-1 / IEC EN 60079-31  
 Gas: II 2 G Ex db eb IIC Gb  
 Staub: II 2 D Ex ta IIIC Da  
 Zone: Gas 1 und 2 / Staub 21 und 22  
 Zertifikat: PTB 00 ATEX 1059  
 IECEx Zertifikat: IECEx PTB 12.0056  
 Einsatztemperatur: -40 °C / +100 °C

Material: Nickel-plated brass  
 O-ring: FPM  
 Protection class: IP 68 (30 bar)  
 Test standard: IEC EN 60079-0 / IEC EN 60079-1 / IEC EN 60079-31  
 Gas: II 2 G Ex db eb IIC Gb  
 Dust: II 2 D Ex ta IIIC Da  
 Zone: Gas 1 and 2 / dust 21 and 22  
 Certificate: PTB 00 ATEX 1059  
 IECEx Certificate: IECEx PTB 12.0056  
 Operation temperature: -40 °C / +100 °C



Mit O-Ring

with O-ring

G	 mm	H mm	L mm	Art.-No.	
M12x1.5	15	5	15	8710.12	10
M16x1.5	18	6	15	8710.17	10
M20x1.5	24	8	15	8710.20	10
M25x1.5	30	10	15	8710.25	10
M32x1.5	36	12	15	8710.32	10
M40x1.5	46	12	15	8710.40	10
M50x1.5	55	12	15	8710.50	10
M63x1.5	70	12	15	8710.63	10

### Anschlussgewinde Pg | Entry thread Pg



Mit O-Ring

with O-ring

G	 mm	H mm	L mm	Art.-No.	
Pg 7	16	6.4	10.5	8710.07	10
Pg 9	18	7.5	12	8710.09	10
Pg 11	21	8.8	12	8710.11	10
Pg 13	24	10.0	14	8710.13	10
Pg 16	27	11.5	14	8710.16	10
Pg 21	32	14.0	16	8710.21	10
Pg 29	41	17.0	17	8710.29	10
Pg 36	55	22.5	17	8710.36	10

# AGRO Kabelverschraubungen Progress® Messing erhöhte Sicherheit Ex e II

## AGRO cable glands Progress® nickel-plated brass increased safety Ex e II

### Kurzes Anschlussgewinde metrisch | Short entry thread metric

Material: Messing vernickelt  
 Dichtung: TPE  
 O-Ring: FPM  
 Schutzart: IP 66 / IP 68 (bis 10 bar)  
 Prüfnorm: IEC EN 60079-0 / IEC EN 60079-7 / IEC EN 60079-31  
 Gas: II 2G Ex eb IIC Gb  
 Staub: II 2D Ex tb IIIC Db  
 Zone: Gas 1 und 2 / Staub 21 und 22  
 Zertifikat: SEV 15 ATEX 0152X  
 IECEx Zertifikat: IECEx SEV 15.0019X  
 CCC Zertifikat: CCC 2022322313004811  
 Einsatztemperatur: -60 °C / +100 °C

Material: Nickel-plated brass  
 Seal: TPE  
 O-ring: FPM  
 Protection class: IP 66 / IP 68 (up to 10 bar)  
 Test standard: IEC EN 60079-0 / IEC EN 60079-7 / IEC EN 60079-31  
 Gas: II 2G Ex eb IIC Gb  
 Dust: II 2D Ex tb IIIC Db  
 Zone: Gas 1 and 2 / dust 21 and 22  
 Certificate: SEV 15 ATEX 0152X  
 IECEx Certificate: IECEx SEV 15.0019X  
 CCC Certificate: CCC 2022322313004811  
 Operation temperature: -60 °C / +100 °C

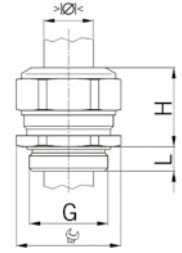

Einteiliger Dichteinsatz  
 Nicht durchgehend isolierend

One-piece sealing insert  
 not overall length insulated

G	$\varnothing$			H	L	i	Art.-No.	
	min mm	max mm						
M8x1.25	3.0	3.5	11	14	5	1	EX1000.08.035	50
M8x1.25	4.0	5.0	11	14	5	1	EX1000.08.050	50
M10x1.5	3.0	4.0	13	15	5	1	EX1000.10.040	50
M10x1.5	4.5	6.0	13	15	5	1	EX1000.10.060	50
M12x1.5	5.0	6.5	15	17	5	-	EX1000.12.065	50
M12x1.5	6.5	8.0	15	17	5	-	EX1000.12.080	50
M16x1.5	4.5	6.0	18	20	5	-	EX1000.17.060	50
M16x1.5	6.0	8.0	18	20	5	-	EX1000.17.080	50
M20x1.5	6.0	8.0	24	21	6	-	EX1000.20.080	50
M20x1.5	8.0	11.0	24	21	6	-	EX1000.20.110	50
M25x1.5	9.5	12.5	30	25	7	-	EX1000.25.125	25
M25x1.5	12.5	16.0	30	27	7	-	EX1000.25.160	25
M32x1.5	14.0	17.0	36	28	8	-	EX1000.32.170	25
M32x1.5	17.0	21.0	36	28	8	-	EX1000.32.210	25
M40x1.5	20.0	24.0	46	31	8	-	EX1000.40.240	10
M40x1.5	24.0	28.5	46	31	8	-	EX1000.40.285	10



Progress MS EX



1 = Metrisches Regelgewinde (mit VDE Testreport)

1 = Metric coarse-pitch thread (with VDE test report)

Auf Anfrage lieferbar:

Available on request:

Ausführungen in Stahl A2 und A4,  
 Anschlussgewinde NPT

Executions in steel A2 and A4, entry thread NPT

# AGRO Kabelverschraubungen Progress® Messing erhöhte Sicherheit Ex e II

## AGRO cable glands Progress® nickel-plated brass increased safety Ex e II

### Langes Anschlussgewinde metrisch | Long entry thread metric

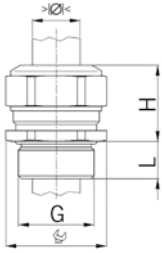

Material: Messing vernickelt  
 Dichtung: TPE  
 O-Ring: FPM  
 Schutzart: IP 66 / IP 68 (bis 10 bar)  
 Prüfnorm: IEC EN 60079-0 / IEC EN 60079-7 / IEC EN 60079-31  
 Gas: II 2G Ex eb IIC Gb  
 Staub: II 2D Ex tb IIIC Db  
 Zone: Gas 1 und 2 / Staub 21 und 22  
 Zertifikat: SEV 15 ATEX 0152X  
 IECEx Zertifikat: IECEx SEV 15.0019X  
 CCC Zertifikat: CCC 2022322313004811  
 Einsatztemperatur: -60 °C / +100 °C

Material: Nickel-plated brass  
 Seal: TPE  
 O-ring: FPM  
 Protection class: IP 66 / IP 68 (up to 10 bar)  
 Test standard: IEC EN 60079-0 / IEC EN 60079-7 / IEC EN 60079-31  
 Gas: II 2G Ex eb IIC Gb  
 Dust: II 2D Ex tb IIIC Db  
 Zone: Gas 1 and 2 / dust 21 and 22  
 Certificate: SEV 15 ATEX 0152X  
 IECEx Certificate: IECEx SEV 15.0019X  
 CCC Certificate: CCC 2022322313004811  
 Operation temperature: -60 °C / +100 °C



Progress MS EX



Einteiliger Dichteinsatz  
 Nicht durchgehend isolierend

One-piece sealing insert  
 not overall length insulated

G	>math>I</math> min mm	>math>I</math> max mm	mm	H mm	L mm	i info	Art.-No.	
M8x1.25	3.0	3.5	11	14	10	1	EX1100.08.035	50
M8x1.25	4.0	5.0	11	14	10	1	EX1100.08.050	50
M10x1.5	3.0	4.0	13	15	10	1	EX1100.10.040	50
M10x1.5	4.5	6.0	13	15	10	1	EX1100.10.060	50
M12x1.5	5.0	6.5	15	17	10	-	EX1100.12.065	50
M12x1.5	6.5	8.0	15	17	10	-	EX1100.12.080	50
M16x1.5	4.5	6.0	18	20	10	-	EX1100.17.060	50
M16x1.5	6.0	8.0	18	20	10	-	EX1100.17.080	50
M20x1.5	6.0	8.0	24	21	10	-	EX1100.20.080	50
M20x1.5	8.0	11.0	24	21	10	-	EX1100.20.110	50
M25x1.5	9.5	12.5	30	25	11	-	EX1100.25.125	25
M25x1.5	12.5	16.0	30	27	11	-	EX1100.25.160	25
M32x1.5	14.0	17.0	36	28	13	-	EX1100.32.170	25
M32x1.5	17.0	21.0	36	28	13	-	EX1100.32.210	25
M40x1.5	20.0	24.0	46	31	13	-	EX1100.40.240	10
M40x1.5	24.0	28.5	46	31	13	-	EX1100.40.285	10

1 = Metrisches Regelgewinde (mit VDE Testreport)

1 = Metric coarse-pitch thread (with VDE test report)

Auf Anfrage lieferbar:

Available on request:

Ausführungen in Stahl A2 und A4,  
 Anschlussgewinde NPT

Executions in steel A2 and A4, entry thread NPT

# AGRO Kabelverschraubungen Progress® Messing erhöhte Sicherheit Ex e II

## AGRO cable glands Progress® nickel-plated brass increased safety Ex e II

### Kurzes Anschlussgewinde Pg | Short entry thread Pg

Material: Messing vernickelt  
 Dichtung: TPE  
 O-Ring: FPM  
 Schutzart: IP 66 / IP 68 (bis 10 bar)  
 Prüfnorm: IEC EN 60079-0 / IEC EN 60079-7 / IEC EN 60079-31  
 Gas: II 2G Ex eb IIC Gb  
 Staub: II 2D Ex tb IIIC Db  
 Zone: Gas 1 und 2 / Staub 21 und 22  
 Zertifikat: SEV 15 ATEX 0152X  
 IECEx Zertifikat: IECEx SEV 15.0019X  
 CCC Zertifikat: CCC 2022322313004811  
 Einsatztemperatur: -60 °C / +100 °C

Material: Nickel-plated brass  
 Seal: TPE  
 O-ring: FPM  
 Protection class: IP 66 / IP 68 (up to 10 bar)  
 Test standard: IEC EN 60079-0 / IEC EN 60079-7 / IEC EN 60079-31  
 Gas: II 2G Ex eb IIC Gb  
 Dust: II 2D Ex tb IIIC Db  
 Zone: Gas 1 and 2 / dust 21 and 22  
 Certificate: SEV 15 ATEX 0152X  
 IECEx Certificate: IECEx SEV 15.0019X  
 CCC Certificate: CCC 2022322313004811  
 Operation temperature: -60 °C / +100 °C

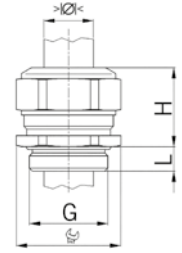

Einteiliger Dichteinsatz  
 Nicht durchgehend isolierend

One-piece sealing insert  
 not overall length insulated

G	$\varnothing$		H mm	L mm	Art.-No.	📦
	min mm	max mm				
Pg 7	5.0	6.5	15	17	EX1000.07.065	50
Pg 7	6.5	8.0	15	17	EX1000.07.080	50
Pg 9	4.5	6.0	18	20	EX1000.09.060	50
Pg 9	6.0	8.0	18	20	EX1000.09.080	50
Pg 11	4.0	5.5	21	21	EX1000.11.055	50
Pg 11	5.5	8.5	21	21	EX1000.11.085	50
Pg 13	6.0	8.0	24	21	EX1000.13.080	50
Pg 13	8.0	11.0	24	21	EX1000.13.110	50
Pg 16	6.0	8.0	24	21	EX1000.16.080	50
Pg 16	8.0	11.0	24	21	EX1000.16.110	50
Pg 21	9.5	12.5	30	25	EX1000.21.125	25
Pg 21	12.5	16.0	30	25	EX1000.21.160	25
Pg 29	16.0	19.0	38	28	EX1000.29.190	25
Pg 29	19.0	23.0	38	28	EX1000.29.230	25
Pg 36	21.5	26.0	50	32	EX1000.36.260	10
Pg 36	26.0	30.5	50	32	EX1000.36.305	10

Auf Anfrage lieferbar:  
 Ausführungen in Stahl A2 und A4,  
 Anschlussgewinde NPT

Available on request:  
 Executions in steel A2 and A4, entry thread NPT



Progress MS EX



# AGRO Kabelverschraubungen Progress® Messing erhöhte Sicherheit Ex e II

## AGRO cable glands Progress® nickel-plated brass increased safety Ex e II

### Langes Anschlussgewinde Pg | Long entry thread Pg

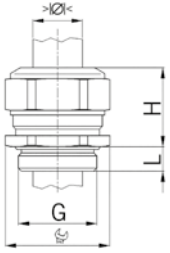

Material: Messing vernickelt  
 Dichtung: TPE  
 O-Ring: FPM  
 Schutzart: IP 66 / IP 68 (bis 10 bar)  
 Prüfnorm: IEC EN 60079-0 / IEC EN 60079-7 / IEC EN 60079-31  
 Gas: II 2G Ex eb IIC Gb  
 Staub: II 2D Ex tb IIIC Db  
 Zone: Gas 1 und 2 / Staub 21 und 22  
 Zertifikat: SEV 15 ATEX 0152X  
 IECEx Zertifikat: IECEx SEV 15.0019X  
 CCC Zertifikat: CCC 2022322313004811  
 Einsatztemperatur: -60 °C / +100 °C

Material: Nickel-plated brass  
 Seal: TPE  
 O-ring: FPM  
 Protection class: IP 66 / IP 68 (up to 10 bar)  
 Test standard: IEC EN 60079-0 / IEC EN 60079-7 / IEC EN 60079-31  
 Gas: II 2G Ex eb IIC Gb  
 Dust: II 2D Ex tb IIIC Db  
 Zone: Gas 1 and 2 / dust 21 and 22  
 Certificate: SEV 15 ATEX 0152X  
 IECEx Certificate: IECEx SEV 15.0019X  
 CCC Certificate: CCC 2022322313004811  
 Operation temperature: -60 °C / +100 °C



Progress MS EX



Einteiliger Dichteinsatz  
 Nicht durchgehend isolierend

One-piece sealing insert  
 not overall length insulated

G	>math>\varnothing</math> min mm	>math>\varnothing</math> max mm	 mm	H mm	L mm	Art.-No.	
Pg 7	5.0	6.5	15	17	10	EX1100.07.065	50
Pg 7	6.5	8.0	15	17	10	EX1100.07.080	50
Pg 9	4.5	6.0	18	20	10	EX1100.09.060	50
Pg 9	6.0	8.0	18	20	10	EX1100.09.080	50
Pg 11	4.0	5.5	21	21	10	EX1100.11.055	50
Pg 11	5.5	8.5	21	21	10	EX1100.11.085	50
Pg 13	6.0	8.0	24	21	10	EX1100.13.080	50
Pg 13	8.0	11.0	24	21	10	EX1100.13.110	50
Pg 16	6.0	8.0	24	21	10	EX1100.16.080	50
Pg 16	8.0	11.0	24	21	10	EX1100.16.110	50
Pg 21	9.5	12.5	30	25	12	EX1100.21.125	25
Pg 21	12.5	16.0	30	25	12	EX1100.21.160	25
Pg 29	16.0	19.0	38	28	12	EX1100.29.190	25
Pg 29	19.0	23.0	38	28	12	EX1100.29.230	25
Pg 36	21.5	26.0	50	32	15	EX1100.36.260	10
Pg 36	26.0	30.5	50	32	15	EX1100.36.305	10

Auf Anfrage lieferbar:  
 Ausführungen in Stahl A2 und A4,  
 Anschlussgewinde NPT

Available on request:  
 Executions in steel A2 and A4, entry thread NPT

Kurzes Anschlussgewinde metrisch | Short entry thread metric

Material: Messing vernickelt  
 Dichtung: TPE / NBR  
 O-Ring: FPM  
 Schutzart: IP 66 / IP 68  
 Prüfnorm: IEC EN 60079-0 / IEC EN 60079-7 / IEC EN 60079-31  
 Gas: II 2G Ex eb IIC Gb  
 Staub: II 2D Ex tb IIIC Db  
 Zone: Gas 1 und 2 / Staub 21 und 22  
 Zertifikat: SEV 15 ATEX 0152X  
 IECEx Zertifikat: IECEx SEV 15.0019X  
 CCC Zertifikat: CCC 2022322313004811  
 Einsatztemperatur: -60 °C / +100 °C

Material: Nickel-plated brass  
 Seal: TPE / NBR  
 O-ring: FPM  
 Protection class: IP 66 / IP 68  
 Test standard: IEC EN 60079-0 / IEC EN 60079-7 / IEC EN 60079-31  
 Gas: II 2G Ex eb IIC Gb  
 Dust: II 2D Ex tb IIIC Db  
 Zone: Gas 1 and 2 / dust 21 and 22  
 Certificate: SEV 15 ATEX 0152X  
 IECEx Certificate: IECEx SEV 15.0019X  
 CCC Certificate: CCC 2022322313004811  
 Operation temperature: -60 °C / +100 °C

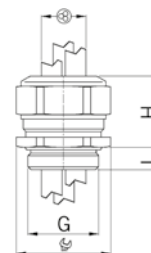

Einteiliger Dichteinsatz  
 Nicht durchgehend isolierend

One-piece sealing insert  
 not overall length insulated

G					H	L	i	Art.-No.	
	min mm	max mm	mm	mm	mm	mm	info		
M12x1.5	0.6	1.0	3	15	17	5	3	EX1310.12.3.010	50
M16x1.5	1.0	1.5	4	18	20	5	3	EX1310.17.4.015	50
M16x1.5	2.0	3.0	2	18	20	5	-	EX1310.17.2.030	50
M20x1.5	2.5	3.0	6	24	21	6	-	EX1310.20.6.030	50
M20x1.5	3.5	5.0	2	24	21	6	-	EX1310.20.2.050	50
M20x1.5	3.5	5.0	4	24	21	6	-	EX1310.20.4.050	50
M20x1.5	4.5	6.0	3	24	21	6	-	EX1310.20.3.060	50
M20x1.5	5.5	7.5	2	24	21	6	-	EX1310.20.2.075	50
M25x1.5	5.0	6.0	6	30	25	7	-	EX1310.25.6.060	25
M25x1.5	6.0	7.0	3	30	25	7	-	EX1310.25.3.070	25
M25x1.5	5.5	7.0	4	30	25	7	-	EX1310.25.4.070	25
M25x1.5	7.5	9.0	3	30	25	7	-	EX1310.25.3.090	25
M25x1.5	8.0	10.0	2	30	25	7	-	EX1310.25.2.100	25
M32x1.5	6.0	7.0	6	36	28	8	-	EX1310.32.6.070	25
M32x1.5	7.5	9.0	4	36	28	8	-	EX1310.32.4.090	25
M40x1.5	8.0	9.0	7	46	31	8	3	EX1310.40.7.090	10
M40x1.5	14.0	15.0	2	46	31	8	3	EX1310.40.2.150	10
M50x1.5	9.0	10.0	4	55	34	9	3	EX1310.50.4.100	10
M63x1.5	11.0	12.0	6	70	37	10	3	EX1310.63.6.120	5
M63x1.5	17.0	18.0	3	70	37	10	3	EX1310.63.3.180	5

3 = Material Dichteinsatz NBR

3 = Material sealing insert NBR

Passende Verschlussbolzen siehe Zubehör

Suitable locking pins see accessories

Auf Anfrage lieferbar:

Available on request:

Ausführungen in Stahl A2 und A4, Anschlussgewinde NPT

Executions in steel A2 and A4, entry thread NPT



Progress MS Multi EX



**Kurzes Anschlussgewinde Pg | Short entry thread Pg**

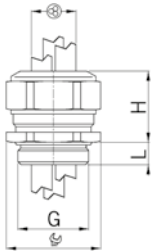

Material: Messing vernickelt  
 Dichtung: TPE / NBR  
 O-Ring: FPM  
 Schutzart: IP 66 / IP 68  
 Prüfnorm: IEC EN 60079-0 / IEC EN 60079-7 / IEC EN 60079-31  
 Gas: II 2G Ex eb IIC Gb  
 Staub: II 2D Ex tb IIIC Db  
 Zone: Gas 1 und 2 / Staub 21 und 22  
 Zertifikat: SEV 15 ATEX 0152X  
 IECEx Zertifikat: IECEx SEV 15.0019X  
 CCC Zertifikat: CCC 2022322313004811  
 Einsatztemperatur: -60 °C / +100 °C

Material: Nickel-plated brass  
 Seal: TPE / NBR  
 O-ring: FPM  
 Protection class: IP 66 / IP 68  
 Test standard: IEC EN 60079-0 / IEC EN 60079-7 / IEC EN 60079-31  
 Gas: II 2G Ex eb IIC Gb  
 Dust: II 2D Ex tb IIIC Db  
 Zone: Gas 1 and 2 / dust 21 and 22  
 Certificate: SEV 15 ATEX 0152X  
 IECEx Certificate: IECEx SEV 15.0019X  
 CCC Certificate: CCC 2022322313004811  
 Operation temperature: -60 °C / +100 °C



Progress MS Multi EX



Einteiliger Dichteinsatz  
 Nicht durchgehend isolierend

One-piece sealing insert  
 not overall length insulated

G	> Ø <	> Ø <	⊗	⊗	H	L	i	Art.-No.	
	min mm	max mm	mm	mm	mm	mm	info		
<b>Pg 9</b>	1.0	1.5	4	18	20	6	3	<b>EX1310.09.4.015</b>	50
<b>Pg 9</b>	2.0	3.0	2	18	20	6	-	<b>EX1310.09.2.030</b>	50
<b>Pg 11</b>	2.0	3.0	3	21	21	6	3	<b>EX1310.11.3.030</b>	50
<b>Pg 11</b>	3.0	4.0	2	21	21	6	3	<b>EX1310.11.2.040</b>	50
<b>Pg 11</b>	3.5	5.0	2	21	21	6	-	<b>EX1310.11.2.050</b>	50
<b>Pg 13</b>	2.5	4.0	3	24	23	6	3	<b>EX1310.13.3.040</b>	50
<b>Pg 13</b>	3.5	5.0	2	24	23	6	-	<b>EX1310.13.2.050</b>	50
<b>Pg 16</b>	2.5	3.0	6	24	23	6	-	<b>EX1310.16.6.030</b>	50
<b>Pg 16</b>	3.0	4.0	6	24	23	6	3	<b>EX1310.16.6.040</b>	50
<b>Pg 16</b>	4.5	6.0	2	24	23	6	-	<b>EX1310.16.2.060</b>	50
<b>Pg 16</b>	4.5	6.0	3	24	23	6	-	<b>EX1310.16.3.060</b>	50
<b>Pg 21</b>	5.5	7.0	4	30	28	7	-	<b>EX1310.21.4.070</b>	25
<b>Pg 21</b>	7.5	9.0	3	30	28	7	-	<b>EX1310.21.3.090</b>	25
<b>Pg 29</b>	5.5	6.5	6	38	28	8	3	<b>EX1310.29.6.065</b>	25
<b>Pg 29</b>	8.0	9.0	3	38	28	8	-	<b>EX1310.29.3.090</b>	25
<b>Pg 36</b>	9.0	10.0	4	50	32	8	3	<b>EX1310.36.4.100</b>	10
<b>Pg 36</b>	14.0	15.0	2	50	32	8	3	<b>EX1310.36.2.150</b>	10
<b>Pg 48</b>	11.0	12.0	6	65	37	11	3	<b>EX1310.48.6.120</b>	10
<b>Pg 48</b>	17.0	18.0	3	65	37	11	3	<b>EX1310.48.3.180</b>	10

3 = Material Dichteinsatz NBR  
 Passende Verschlussbolzen siehe Zubehör  
 Auf Anfrage lieferbar:  
 Ausführungen in Stahl A2 und A4,  
 Anschlussgewinde NPT

3 = Material sealing insert NBR  
 Suitable locking pins see accessories  
 Available on request:  
 Executions in steel A2 and A4, entry thread NPT

Kurzes Anschlussgewinde metrisch | Short entry thread metric

Material:	Messing vernickelt	Material:	Nickel-plated brass
Schrauben:	Rostfreier Stahl A2	Screws:	Stainless steel A2
Dichtung:	TPE	Seal:	TPE
O-Ring:	FPM	O-ring:	FPM
Schutzart:	IP 66 / IP 68 (bis 10 bar)	Protection class:	IP 66 / IP 68 (up to 10 bar)
Prüfnorm:	IEC EN 60079-0 / IEC EN 60079-7 / IEC EN 60079-31	Test standard:	IEC EN 60079-0 / IEC EN 60079-7 / IEC EN 60079-31
Gas:	II 2G Ex eb IIC Gb	Gas:	II 2G Ex eb IIC Gb
Staub:	II 2D Ex tb IIIC Db	Dust:	II 2D Ex tb IIIC Db
Zone:	Gas 1 und 2 / Staub 21 und 22	Zone:	Gas 1 and 2 / dust 21 and 22
Zertifikat:	SEV 15 ATEX 0151	Certificate:	SEV 15 ATEX 0151
IECEX Zertifikat:	IECEX SEV 15.0018	IECEX Certificate:	IECEX SEV 15.0018
CCC Zertifikat:	CCC 2022322313004717	CCC Certificate:	CCC 2022322313004717
Einsatztemperatur:	-60 °C / +100 °C	Operation temperature:	-60 °C / +100 °C

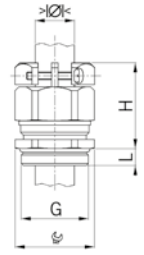

Zweiteiliger Dichteinsatz  
Nicht durchgehend isolierend

Two-piece sealing insert  
not overall length insulated

G	$\varnothing$		$\varnothing$		$\varnothing$	H	L	i	$\varnothing$		Art.-No.	
	min mm	max mm	min mm	max mm					min mm	max mm		
M12x1.5	-	-	5.0	6.5	15/16	26	5	1/2	-	-	EX1803.12.03.065	50
M12x1.5	-	-	6.5	8.0	15/16	26	5	1/2	-	-	EX1803.12.03.080	50
M16x1.5	6.0	8.0	-	-	18/19	30	5	-	8.0	10.5	EX1803.17	50
M20x1.5	8.0	11.0	-	-	24	31	6	-	11.0	15.0	EX1803.20	50
M25x1.5	12.5	16.0	-	-	30	35	7	-	16.0	20.5	EX1803.25	25
M32x1.5	17.0	21.0	-	-	36	40	8	-	21.0	25.5	EX1803.32	25
M40x1.5	24.0	28.5	-	-	46	44	8	-	28.5	33.0	EX1803.40	10
M50x1.5	33.0	37.0	-	-	55	49	9	-	37.0	42.0	EX1803.50	10
M63x1.5	40.0	46.0	-	-	70	55	10	-	46.0	52.0	EX1803.63	5



Progress MS KB EX



1 = Einteiliger Dichteinsatz

1 = One-piece sealing insert

2 = Zertifikat SEV 15 ATEX 0152X / IECEx SEV 15.0019X

2 = Certificate SEV 15 ATEX 0152X / IECEx SEV 15.0019X

Auf Anfrage lieferbar:

Available on request:

Langes Anschlussgewinde

Long entry thread

Ausführungen in Stahl A2 und A4

Executions in steel A2 and A4

Kurzes Anschlussgewinde Pg | Short entry thread Pg

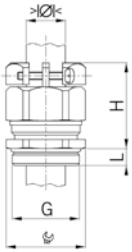

Material:	Messing vernickelt	Material:	Nickel-plated brass
Schrauben:	Rostfreier Stahl A2	Screws:	Stainless steel A2
Dichtung:	TPE	Seal:	TPE
O-Ring:	FPM	O-ring:	FPM
Schutzart:	IP 66 / IP 68 (bis 10 bar)	Protection class:	IP 66 / IP 68 (up to 10 bar)
Prüfnorm:	IEC EN 60079-0 / IEC EN 60079-7 / IEC EN 60079-31	Test standard:	IEC EN 60079-0 / IEC EN 60079-7 / IEC EN 60079-31
Gas:	II 2G Ex eb IIC Gb	Gas:	II 2G Ex eb IIC Gb
Staub:	II 2D Ex tb IIIC Db	Dust:	II 2D Ex tb IIIC Db
Zone:	Gas 1 und 2 / Staub 21 und 22	Zone:	Gas 1 and 2 / dust 21 and 22
Zertifikat:	SEV 15 ATEX 0151	Certificate:	SEV 15 ATEX 0151
IECEX Zertifikat:	IECEX SEV 15.0018	IECEX Certificate:	IECEX SEV 15.0018
CCC Zertifikat:	CCC 2022322313004717	CCC Certificate:	CCC 2022322313004717
Einsatztemperatur:	-60 °C / +100 °C	Operation temperature:	-60 °C / +100 °C



Progress MS KB EX



Zweiteiliger Dichteinsatz  
Nicht durchgehend isolierend

Two-piece sealing insert  
not overall length insulated

G	Ø		Ø		mm	H	L	i	Ø		Art.-No.	img alt="box icon" data-bbox="890 385 915 400"/>
	min mm	max mm	min mm	max mm					min mm	max mm		
Pg 7	-	-	5.0	6.5	15/16	26	6	1/2	-	-	EX1803.07.03.065	50
Pg 7	-	-	6.5	8.0	15/16	26	6	1/2	-	-	EX1803.07.03.080	50
Pg 9	6.0	8.0	-	-	18/19	30	6	-	8.0	10.5	EX1803.09	50
Pg 11	5.5	8.5	-	-	21	31	6	-	8.5	12.0	EX1803.11	50
Pg 13	8.0	11.0	-	-	24	31	6	-	11.0	15.0	EX1803.13	50
Pg 16	8.0	11.0	-	-	24	31	6	-	11.0	15.0	EX1803.16	50
Pg 21	12.5	16.0	-	-	30	35	7.5	-	16.0	20.5	EX1803.21	25
Pg 29	19.0	23.0	-	-	38	40	8	-	23.0	27.5	EX1803.29	25
Pg 36	26.0	30.5	-	-	50	47	8	-	30.5	35.0	EX1803.36	10
Pg 42	33.0	37.0	-	-	55	49	10	-	37.0	42.0	EX1803.42	10
Pg 48	37.0	43.0	-	-	65	51	11	-	43.0	49.0	EX1803.48	5

1 = Einteiliger Dichteinsatz

1 = One-piece sealing insert

2 = Zertifikat SEV 15 ATEX 0152X / IECEx SEV 15.0019X

2 = Certificate SEV 15 ATEX 0152X / IECEx SEV 15.0019X

Auf Anfrage lieferbar:

Available on request:

Langes Anschlussgewinde

Long entry thread

Ausführungen in Stahl A2 und A4

Executions in steel A2 and A4

**Kurzes Anschlussgewinde metrisch | Short entry thread metric**

Material:	Messing vernickelt	Material:	Nickel-plated brass
Schrauben:	Rostfreier Stahl A2	Screws:	Stainless steel A2
Dichtung:	TPE	Seal:	TPE
O-Ring:	FPM	O-ring:	FPM
Schutzart:	IP 66 / IP 68 (bis 10 bar)	Protection class:	IP 66 / IP 68 (up to 10 bar)
Prüfnorm:	IEC EN 60079-0 / IEC EN 60079-7 / IEC EN 60079-31	Test standard:	IEC EN 60079-0 / IEC EN 60079-7 / IEC EN 60079-31
Gas:	II 2G Ex eb IIC Gb	Gas:	II 2G Ex eb IIC Gb
Staub:	II 2D Ex tb IIIC Db	Dust:	II 2D Ex tb IIIC Db
Zone:	Gas 1 und 2 / Staub 21 und 22	Zone:	Gas 1 and 2 / dust 21 and 22
Zertifikat:	SEV 15 ATEX 0151	Certificate:	SEV 15 ATEX 0151
IECEX Zertifikat:	IECEX SEV 15.0018	IECEX Certificate:	IECEX SEV 15.0018
CCC Zertifikat:	CCC 2022322313004717	CCC Certificate:	CCC 2022322313004717
Einsatztemperatur:	-60 °C / +100 °C	Operation temperature:	-60 °C / +100 °C

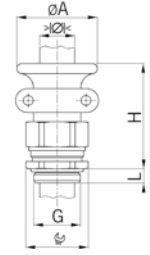

Zweiteiliger Dichteinsatz  
Nicht durchgehend isolierend

Two-piece sealing insert  
not overall length insulated

G	$\begin{matrix} > \ominus < \\ \text{min mm} \end{matrix}$	$\begin{matrix} > \ominus < \\ \text{max mm} \end{matrix}$	$\begin{matrix} > \ominus < \\ \text{min mm} \end{matrix}$	$\begin{matrix} > \ominus < \\ \text{max mm} \end{matrix}$	$\begin{matrix} \text{mm} \\ \text{mm} \end{matrix}$	ØA	H	L	Art.-No.	
M16x1.5	6.0	8.0	8.0	10.5	18	28	43	5	EX1801.17	50
M20x1.5	8.0	11.0	11.0	15.0	24	34	46	6	EX1801.20	50
M25x1.5	12.5	16.0	16.0	20.5	30	44	52	7	EX1801.25	25
M32x1.5	17.0	21.0	21.0	25.5	36	50	59	8	EX1801.32	10
M40x1.5	24.0	28.5	28.5	33.0	46	57	59	8	EX1801.40	5



Progress MS T+KB EX



**Langes Anschlussgewinde metrisch | Long entry thread metric**

Zweiteiliger Dichteinsatz  
Nicht durchgehend isolierend

Two-piece sealing insert  
not overall length insulated

G	$\begin{matrix} > \ominus < \\ \text{min mm} \end{matrix}$	$\begin{matrix} > \ominus < \\ \text{max mm} \end{matrix}$	$\begin{matrix} > \ominus < \\ \text{min mm} \end{matrix}$	$\begin{matrix} > \ominus < \\ \text{max mm} \end{matrix}$	$\begin{matrix} \text{mm} \\ \text{mm} \end{matrix}$	ØA	H	L	Art.-No.	
M16x1.5	6.0	8.0	8.0	10.5	18	28	43	10	EX1811.17	50
M20x1.5	8.0	11.0	11.0	15.0	24	34	46	10	EX1811.20	50
M25x1.5	12.5	16.0	16.0	20.5	30	44	52	11	EX1811.25	25
M32x1.5	17.0	21.5	21.5	25.5	36	50	59	13	EX1811.32	10
M40x1.5	24.0	28.5	28.5	33.0	46	57	59	13	EX1811.40	5



Progress MS T+KB EX



**Kurzes Anschlussgewinde Pg | Short entry thread Pg**

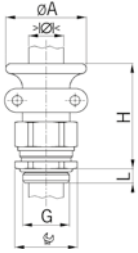

Material:	Messing vernickelt	Material:	Nickel-plated brass
Schrauben:	Rostfreier Stahl A2	Screws:	Stainless steel A2
Dichtung:	TPE	Seal:	TPE
O-Ring:	FPM	O-ring:	FPM
Schutzart:	IP 66 / IP 68 (bis 10 bar)	Protection class:	IP 66 / IP 68 (up to 10 bar)
Prüfnorm:	IEC EN 60079-0 / IEC EN 60079-7 / IEC EN 60079-31	Test standard:	IEC EN 60079-0 / IEC EN 60079-7 / IEC EN 60079-31
Gas:	II 2G Ex eb IIC Gb	Gas:	II 2G Ex eb IIC Gb
Staub:	II 2D Ex tb IIIC Db	Dust:	II 2D Ex tb IIIC Db
Zone:	Gas 1 und 2 / Staub 21 und 22	Zone:	Gas 1 and 2 / dust 21 and 22
Zertifikat:	SEV 15 ATEX 0151	Certificate:	SEV 15 ATEX 0151
IECEx Zertifikat:	IECEx SEV 15.0018	IECEx Certificate:	IECEx SEV 15.0018
CCC Zertifikat:	CCC 2022322313004717	CCC Certificate:	CCC 2022322313004717
Einsatztemperatur:	-60 °C / +100 °C	Operation temperature:	-60 °C / +100 °C



Progress MS T+KB EX



Zweiteiliger Dichteinsatz  
Nicht durchgehend isolierend

Two-piece sealing insert  
not overall length insulated

G	> Ø < min mm	> Ø < max mm	> Ø < min mm	> Ø < max mm	mm	ØA mm	H mm	L mm	Art.-No.	
Pg 9	6.0	8.0	8.0	10.5	18	28	43	6	EX1801.09	50
Pg 11	5.5	8.5	8.5	12.0	21	30	43	6	EX1801.11	50
Pg 13	8.0	11.0	11.0	15.0	24	34	46	6	EX1801.13	50
Pg 16	8.0	11.0	11.0	15.0	24	34	46	6	EX1801.16	50
Pg 21	12.5	16.0	16.0	20.5	30	44	52	7.5	EX1801.21	25
Pg 29	19.0	23.0	23.0	27.5	38	50	59	8	EX1801.29	10

**Langes Anschlussgewinde Pg | Long entry thread Pg**



Progress MS T+KB EX



Zweiteiliger Dichteinsatz  
Nicht durchgehend isolierend

Two-piece sealing insert  
not overall length insulated

G	> Ø < min mm	> Ø < max mm	> Ø < min mm	> Ø < max mm	mm	ØA mm	H mm	L mm	Art.-No.	
Pg 9	6.0	8.0	8.0	10.5	18	28	43	10	EX1811.09	50
Pg 11	5.5	8.5	8.5	12.0	21	30	43	10	EX1811.11	50
Pg 13	8.0	11.0	11.0	15.0	24	34	46	10	EX1811.13	50
Pg 16	8.0	11.0	11.0	15.0	24	34	46	10	EX1811.16	50
Pg 21	12.5	16.0	16.0	20.5	30	44	52	12	EX1811.21	25
Pg 29	19.0	23.0	23.0	27.5	38	50	59	12	EX1811.29	10

**Kurzes Anschlussgewinde metrisch | Short entry thread metric**

Material:	Messing vernickelt	Material:	Nickel-plated brass
Dichtung:	TPE	Seal:	TPE
O-Ring:	FPM	O-ring:	FPM
Schutzart:	IP 66 / IP 68 (bis 10 bar)	Protection class:	IP 66 / IP 68 (up to 10 bar)
Prüfnorm:	IEC EN 60079-0 / IEC EN 60079-7 / IEC EN 60079-31	Test standard:	IEC EN 60079-0 / IEC EN 60079-7 / IEC EN 60079-31
Gas:	II 2G Ex eb IIC Gb	Gas:	II 2G Ex eb IIC Gb
Staub:	II 2D Ex tb IIIC Db	Dust:	II 2D Ex tb IIIC Db
Zone:	Gas 1 und 2 / Staub 21 und 22	Zone:	Gas 1 and 2 / dust 21 and 22
Zertifikat:	SEV 15 ATEX 0152X	Certificate:	SEV 15 ATEX 0152X
IECEX Zertifikat:	IECEX SEV 15.0019X	IECEX Certificate:	IECEX SEV 15.0019X
CCC Zertifikat:	CCC 2022322313004811	CCC Certificate:	CCC 2022322313004811
Eigenschaften:	Für zeitsparende Montage von partiell abisolierten sowie durchgehend geschirmten Kabeln	Properties:	For a quick installation of partially dismantled cables as well as thoroughly shielded cables
Einsatztemperatur:	-60 °C / +100 °C	Operation temperature:	-60 °C / +100 °C

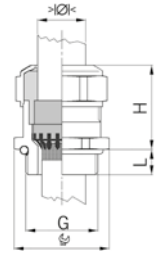

Einteiliger Dichteinsatz Nicht durchgehend isolierend		One-piece sealing insert not overall length insulated					
<b>G</b>	$\begin{matrix} > \varnothing < \\ \text{min mm} \end{matrix}$	$\begin{matrix} > \varnothing < \\ \text{max mm} \end{matrix}$	$\begin{matrix} \varnothing \\ \text{mm} \end{matrix}$				
	<b>H</b>	<b>L</b>	<b>Art.-No.</b>				
	mm	mm					
<b>M12x1.5</b>	4.5	6.0	15	20	5	<b>EX1081.12.060</b>	50
<b>M12x1.5</b>	6.0	7.5	15	20	5	<b>EX1081.12.075</b>	50
<b>M16x1.5</b>	6.0	8.0	18	23	5	<b>EX1081.17.080</b>	50
<b>M16x1.5</b>	8.0	10.0	18	25	5	<b>EX1081.17.100</b>	50
<b>M20x1.5</b>	8.0	11.0	24	25	6	<b>EX1081.20.110</b>	50
<b>M20x1.5</b>	11.0	14.0	24	27	6	<b>EX1081.20.140</b>	50
<b>M25x1.5</b>	13.0	16.0	30	30	7	<b>EX1081.25.160</b>	25
<b>M25x1.5</b>	17.0	19.0	30	33	7	<b>EX1081.25.190</b>	25
<b>M32x1.5</b>	18.0	21.0	36	32	8	<b>EX1081.32.210</b>	25
Langes Anschlussgewinde auf Anfrage				Long entry thread available on request			



Progress MS EMC Rapid EX



**Kurzes Anschlussgewinde Pg | Short entry thread Pg**

Einteiliger Dichteinsatz Nicht durchgehend isolierend		One-piece sealing insert not overall length insulated					
<b>G</b>	$\begin{matrix} > \varnothing < \\ \text{min mm} \end{matrix}$	$\begin{matrix} > \varnothing < \\ \text{max mm} \end{matrix}$	$\begin{matrix} \varnothing \\ \text{mm} \end{matrix}$				
	<b>H</b>	<b>L</b>	<b>Art.-No.</b>				
	mm	mm					
<b>Pg 7</b>	4.5	6.0	15	20	6	<b>EX1081.07.060</b>	50
<b>Pg 7</b>	6.0	7.5	15	20	6	<b>EX1081.07.075</b>	50
<b>Pg 9</b>	6.0	8.0	18	23	6	<b>EX1081.09.080</b>	50
<b>Pg 9</b>	8.0	10.0	18	25	6	<b>EX1081.09.100</b>	50
<b>Pg 11</b>	5.5	8.5	21	25	6	<b>EX1081.11.085</b>	50
<b>Pg 11</b>	8.5	12.0	21	25	6	<b>EX1081.11.120</b>	50
<b>Pg 13</b>	8.0	11.0	24	25	6	<b>EX1081.13.110</b>	50
<b>Pg 13</b>	12.5	14.0	24	27	6	<b>EX1081.13.140</b>	50
<b>Pg 16</b>	8.0	11.0	24	24	6	<b>EX1081.16.110</b>	50
<b>Pg 16</b>	12.5	14.0	24	27	6	<b>EX1081.16.140</b>	50
<b>Pg 21</b>	13.0	16.0	30	30	7	<b>EX1081.21.160</b>	25
<b>Pg 21</b>	17.0	19.0	30	33	7	<b>EX1081.21.190</b>	25
<b>Pg 29</b>	19.0	23.0	38	33	8	<b>EX1081.29.230</b>	25
<b>Pg 29</b>	23.0	25.5	38	32	8	<b>EX1081.29.255</b>	25
Langes Anschlussgewinde auf Anfrage				Long entry thread available on request			



Progress MS EMC Rapid EX



Kurzes Anschlussgewinde metrisch | Short entry thread metric

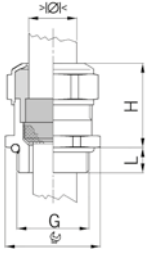

Material: Messing vernickelt  
 Dichtung: TPE  
 O-Ring: FPM  
 Schutzart: IP 66 / IP 68 (bis 10 bar)  
 Prüfnorm: IEC EN 60079-0 / IEC EN 60079-7 / IEC EN 60079-31  
 Gas: II 2G Ex eb IIC Gb  
 Staub: II 2D Ex tb IIIC Db  
 Zone: Gas 1 und 2 / Staub 21 und 22  
 Zertifikat: SEV 15 ATEX 0152X  
 IECEx Zertifikat: IECEx SEV 15.0019X  
 CCC Zertifikat: CCC 2022322313004811  
 Eigenschaften: Sehr guter Schirmkontakt über die Kontakthülse bei in der Kabelverschraubung endendem Schirmgeflecht

Material: Nickel-plated brass  
 Seal: TPE  
 O-ring: FPM  
 Protection class: IP 66 / IP 68 (up to 10 bar)  
 Test standard: IEC EN 60079-0 / IEC EN 60079-7 / IEC EN 60079-31  
 Gas: II 2G Ex eb IIC Gb  
 Dust: II 2D Ex tb IIIC Db  
 Zone: Gas 1 and 2 / dust 21 and 22  
 Certificate: SEV 15 ATEX 0152X  
 IECEx Certificate: IECEx SEV 15.0019X  
 CCC Certificate: CCC 2022322313004811  
 Properties: Excellent shield contact through the contact sleeve with the braided shield terminating in the screwed cable gland

Einsatztemperatur: -60 °C / +100 °C

Operation temperature: -60 °C / +100 °C



Progress MS EMC EX



Einteiliger Dichteinsatz  
 Nicht durchgehend isolierend

One-piece sealing insert  
 not overall length insulated

G	>Ø1< min mm	>Ø2< max mm	mm	H mm	L mm	i info	Art.-No.	
M8x1.25	2.5	3.5	11	15	5	1	EX1080.08.035	50
M8x1.25	3.0	4.0	11	15	5	1	EX1080.08.040	50
M10x1.5	3.0	4.0	13	16	5	1	EX1080.10.040	50
M10x1.5	4.0	6.0	13	16	5	1	EX1080.10.060	50
M12x1.5	4.5	6.0	15	20	5	-	EX1080.12.060	50
M12x1.5	6.0	7.5	15	20	5	-	EX1080.12.075	50
M16x1.5	6.0	8.0	18	23	5	-	EX1080.17.080	50
M16x1.5	8.0	10.0	18	25	5	-	EX1080.17.100	50
M20x1.5	8.0	11.0	24	25	6	-	EX1080.20.110	50
M20x1.5	12.5	14.0	24	27	6	-	EX1080.20.140	50
M25x1.5	13.0	16.0	30	30	7	-	EX1080.25.160	25
M25x1.5	17.0	19.0	30	33	7	-	EX1080.25.190	25
M32x1.5	17.0	21.0	36	32	8	-	EX1080.32.210	25
M40x1.5	24.0	28.5	46	34	8	-	EX1080.40.285	10

1 = Metrisches Regelgewinde (mit VDE Testreport)

1 = Metric coarse-pitch thread (with VDE test report)

Langes Anschlussgewinde auf Anfrage

Long entry thread available on request

**Kurzes Anschlussgewinde Pg | Short entry thread Pg**

Material:	Messing vernickelt	Material:	Nickel-plated brass
Dichtung:	TPE	Seal:	TPE
O-Ring:	FPM	O-ring:	FPM
Schutzart:	IP 66 / IP 68 (bis 10 bar)	Protection class:	IP 66 / IP 68 (up to 10 bar)
Prüfnorm:	IEC EN 60079-0 / IEC EN 60079-7 / IEC EN 60079-31	Test standard:	IEC EN 60079-0 / IEC EN 60079-7 / IEC EN 60079-31
Gas:	II 2G Ex eb IIC Gb	Gas:	II 2G Ex eb IIC Gb
Staub:	II 2D Ex tb IIIC Db	Dust:	II 2D Ex tb IIIC Db
Zone:	Gas 1 und 2 / Staub 21 und 22	Zone:	Gas 1 and 2 / dust 21 and 22
Zertifikat:	SEV 15 ATEX 0152X	Certificate:	SEV 15 ATEX 0152X
IECEX Zertifikat:	IECEX SEV 15.0019X	IECEX Certificate:	IECEX SEV 15.0019X
CCC Zertifikat:	CCC 2022322313004811	CCC Certificate:	CCC 2022322313004811
Eigenschaften:	Sehr guter Schirmkontakt über die Kontakthülse bei in der Kabelverschraubung endendem Schirmgeflecht	Properties:	Excellent shield contact through the contact sleeve with the braided shield terminating in the screwed cable gland
Einsatztemperatur:	-60 °C / +100 °C	Operation temperature:	-60 °C / +100 °C

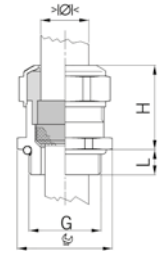

Einteiliger Dichteinsatz Nicht durchgehend isolierend						One-piece sealing insert not overall length insulated	
G	>10<	>10<	H	L	Art.-No.		
	min mm	max mm	mm	mm			
<b>Pg 7</b>	4.5	6.0	15	20	<b>EX1080.07.060</b>	50	
<b>Pg 7</b>	6.0	7.5	15	20	<b>EX1080.07.075</b>	50	
<b>Pg 9</b>	6.0	8.0	18	23	<b>EX1080.09.080</b>	50	
<b>Pg 9</b>	8.0	10.0	18	25	<b>EX1080.09.100</b>	50	
<b>Pg 11</b>	5.5	8.5	21	23	<b>EX1080.11.085</b>	50	
<b>Pg 11</b>	9.5	12.0	21	23	<b>EX1080.11.120</b>	50	
<b>Pg 13</b>	8.0	11.0	24	25	<b>EX1080.13.110</b>	50	
<b>Pg 13</b>	12.5	14.0	24	27	<b>EX1080.13.140</b>	50	
<b>Pg 16</b>	8.0	11.0	24	24	<b>EX1080.16.110</b>	50	
<b>Pg 16</b>	12.5	14.0	24	27	<b>EX1080.16.140</b>	50	
<b>Pg 21</b>	13.0	16.0	30	30	<b>EX1080.21.160</b>	25	
<b>Pg 21</b>	17.0	19.0	30	33	<b>EX1080.21.190</b>	25	
<b>Pg 29</b>	19.0	23.0	38	33	<b>EX1080.29.230</b>	25	
<b>Pg 29</b>	24.0	25.5	38	32	<b>EX1080.29.255</b>	25	
<b>Pg 36</b>	25.0	30.5	50	36	<b>EX1080.36.305</b>	10	
Langes Anschlussgewinde auf Anfrage						Long entry thread available on request	



**Progress MS EMC EX**



**Kurzes Anschlussgewinde metrisch | Short entry thread metric**

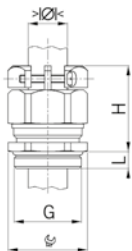

Material: Messing vernickelt  
 Schrauben: Rostfreier Stahl A2  
 Dichtung: TPE  
 O-Ring: FPM  
 Schutzart: IP 66 / IP 68 (bis 10 bar)  
 Prüfnorm: IEC EN 60079-0 / IEC EN 60079-7 / IEC EN 60079-31  
 Gas: II 2G Ex eb IIC Gb  
 Staub: II 2D Ex tb IIIC Db  
 Zone: Gas 1 und 2 / Staub 21 und 22  
 Zertifikat: SEV 15 ATEX 0151  
 IECEx Zertifikat: IECEx SEV 15.0018  
 CCC Zertifikat: CCC 2022322313004717  
 Einsatztemperatur: -60 °C / +100 °C

Material: Nickel-plated brass  
 Screws: Stainless steel A2  
 Seal: TPE  
 O-ring: FPM  
 Protection class: IP 66 / IP 68 (up to 10 bar)  
 Test standard: IEC EN 60079-0 / IEC EN 60079-7 / IEC EN 60079-31  
 Gas: II 2G Ex eb IIC Gb  
 Dust: II 2D Ex tb IIIC Db  
 Zone: Gas 1 and 2 / dust 21 and 22  
 Certificate: SEV 15 ATEX 0151  
 IECEx Certificate: IECEx SEV 15.0018  
 CCC Certificate: CCC 2022322313004717  
 Operation temperature: -60 °C / +100 °C



**Progress MS  
EMC KB EX**



Einteiliger Dichteinsatz  
Nicht durchgehend isolierend

One-piece sealing insert  
not overall length insulated

G	> Ø <	> Ø <	mm	H	L	i	Art.-No.	
	min mm	max mm		mm	mm	info		
M12x1.5	4.5	6.0	15/16	26	5	1	EX1803.80.12.060	50
M12x1.5	6.0	7.5	15/16	26	5	1	EX1803.80.12.075	50
M16x1.5	6.0	8.0	18/19	30	5	-	EX1803.80.17.080	50
M16x1.5	8.0	10.0	18/19	30	5	-	EX1803.80.17.100	50
M20x1.5	8.0	11.0	24	31	6	-	EX1803.80.20.110	50
M20x1.5	11.0	14.0	24	31	6	-	EX1803.80.20.140	50
M25x1.5	13.0	16.0	30	35	7	-	EX1803.80.25.160	25
M25x1.5	16.0	19.0	30	35	7	-	EX1803.80.25.190	25
M32x1.5	18.0	21.0	36	40	8	-	EX1803.80.32.210	25
M32x1.5	21.0	25.0	36	40	8	-	EX1803.80.32.250	25
M40x1.5	24.0	28.5	46	44	8	-	EX1803.80.40.285	10
M40x1.5	28.5	32.0	46	44	8	-	EX1803.80.40.320	10
M50x1.5	33.0	37.0	55	49	9	-	EX1803.80.50.370	10
M50x1.5	37.0	41.0	55	49	9	-	EX1803.80.50.410	10
M63x1.5	40.0	46.0	70	55	10	-	EX1803.80.63.460	5
M63x1.5	46.0	50.0	70	55	10	-	EX1803.80.63.500	5

1 = Zertifikat SEV 15 ATEX 0152X / IECEx SEV 15.0019X

1 = Certificate SEV 15 ATEX 0152X / IECEx SEV 15.0019X

Langes Anschlussgewinde auf Anfrage

Long entry thread available on request

**Kurzes Anschlussgewinde Pg | Short entry thread Pg**

Material:	Messing vernickelt	Material:	Nickel-plated brass
Schrauben:	Rostfreier Stahl A2	Screws:	Stainless steel A2
Dichtung:	TPE	Seal:	TPE
O-Ring:	FPM	O-ring:	FPM
Schutzart:	IP 66 / IP 68 (bis 10 bar)	Protection class:	IP 66 / IP 68 (up to 10 bar)
Prüfnorm:	IEC EN 60079-0 / IEC EN 60079-7 / IEC EN 60079-31	Test standard:	IEC EN 60079-0 / IEC EN 60079-7 / IEC EN 60079-31
Gas:	II 2G Ex eb IIC Gb	Gas:	II 2G Ex eb IIC Gb
Staub:	II 2D Ex tb IIIC Db	Dust:	II 2D Ex tb IIIC Db
Zone:	Gas 1 und 2 / Staub 21 und 22	Zone:	Gas 1 and 2 / dust 21 and 22
Zertifikat:	SEV 15 ATEX 0151	Certificate:	SEV 15 ATEX 0151
IECEX Zertifikat:	IECEX SEV 15.0018	IECEX Certificate:	IECEX SEV 15.0018
CCC Zertifikat:	CCC 2022322313004717	CCC Certificate:	CCC 2022322313004717
Einsatztemperatur:	-60 °C / +100 °C	Operation temperature:	-60 °C / +100 °C

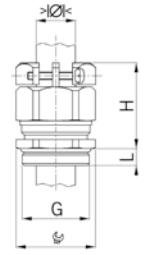

Einteiliger Dichteinsatz  
Nicht durchgehend isolierend

One-piece sealing insert  
not overall length insulated

G	>10<	>10<		H	L	i	Art.-No.	
	min mm	max mm	mm	mm	mm	info		
Pg 7	4.5	6.0	15/16	26	6	1	EX1803.80.07.060	50
Pg 7	6.0	7.5	15/16	26	6	1	EX1803.80.07.075	50
Pg 9	6.0	8.0	18/19	30	6	-	EX1803.80.09.080	50
Pg 9	8.0	10.0	18/19	30	6	-	EX1803.80.09.100	50
Pg 11	5.5	8.5	21	31	6	-	EX1803.80.11.085	50
Pg 11	8.5	12.0	21	31	6	-	EX1803.80.11.120	50
Pg 13	8.0	11.0	24	31	6	-	EX1803.80.13.110	50
Pg 13	11.0	14.0	24	31	6	-	EX1803.80.13.140	50
Pg 16	8.0	11.0	24	31	6	-	EX1803.80.16.110	50
Pg 16	11.0	14.0	24	31	6	-	EX1803.80.16.140	50
Pg 21	13.0	16.0	30	35	7.5	-	EX1803.80.21.160	25
Pg 21	16.0	19.0	30	35	7.5	-	EX1803.80.21.190	25
Pg 29	19.0	23.0	38	40	8	-	EX1803.80.29.230	25
Pg 29	23.0	25.5	38	40	8	-	EX1803.80.29.255	25
Pg 36	25.0	30.5	50	47	8	-	EX1803.80.36.305	10
Pg 36	30.5	35.0	50	47	8	-	EX1803.80.36.350	10
Pg 42	33.0	37.0	55	49	10	-	EX1803.80.42.370	10
Pg 42	37.0	41.0	55	49	10	-	EX1803.80.42.410	10
Pg 48	39.0	43.0	65	51	11	-	EX1803.80.48.430	5
Pg 48	43.0	46.5	65	51	11	-	EX1803.80.48.465	5

1 = Zertifikat SEV 15 ATEX 0152X /  
IECEX SEV 15.0019X

1 = Certificate SEV 15 ATEX 0152X /  
IECEX SEV 15.0019X

Langes Anschlussgewinde auf Anfrage

Long entry thread available on request



Progress MS  
EMC KB EX



**Kurzes Anschlussgewinde metrisch | Short entry thread metric**

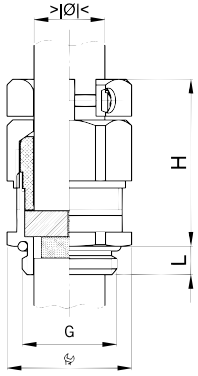

Material: Messing vernickelt  
 Schrauben: Rostfreier Stahl A2  
 Dichtung: TPE  
 O-Ring: FPM  
 Schutzart: IP 66 / IP 68  
 Prüfnorm: IEC EN 60079-0 / IEC EN 60079-7 / IEC EN 60079-31  
 Gas: II 2G Ex eb IIC Gb  
 Staub: II 2D Ex tb IIIC Db  
 Zone: Gas 1 und 2 / Staub 21 und 22  
 Zertifikat: SEV 15 ATEX 0151  
 IECEx Zertifikat: IECEx SEV 15.0018  
 CCC Zertifikat: CCC 2022322313004717  
 Einsatztemperatur: -60 °C / +100 °C

Material: Nickel-plated brass  
 Screws: Stainless steel A2  
 Seal: TPE  
 O-ring: FPM  
 Protection class: IP 66 / IP 68  
 Test standard: IEC EN 60079-0 / IEC EN 60079-7 / IEC EN 60079-31  
 Gas: II 2G Ex eb IIC Gb  
 Dust: II 2D Ex tb IIIC Db  
 Zone: Gas 1 and 2 / dust 21 and 22  
 Certificate: SEV 15 ATEX 0151  
 IECEx Certificate: IECEx SEV 15.0018  
 CCC Certificate: CCC 2022322313004717  
 Operation temperature: -60 °C / +100 °C



Progress MS EMV easyCONNECT KB EX



Zweiteiliger Dichteinsatz  
 Nicht durchgehend isolierend

Two-piece sealing insert  
 not overall length insulated

G	>Ø1< min mm	>Ø1< max mm	>Ø1< min mm	>Ø1< max mm	mm	H mm	L mm	i info	>Ø1< min mm	>Ø1< max mm	Art.-No.	
M12x1.5	-	-	5.0	6.5	15/16	31	5	1/2	-	-	EX1803.83.12.065	50
M16x1.5	6.0	8.0	-	-	18/19	33	5	-	8.0	10.5	EX1803.83.17	50
M20x1.5	8.0	11.0	-	-	24	35	6	-	11.0	15.0	EX1803.83.20	50
M25x1.5	12.5	16.0	-	-	30	40	7	-	16.0	20.5	EX1803.83.25	25
M32x1.5	17.0	21.0	-	-	36	45	8	-	21.0	25.5	EX1803.83.32	25
M40x1.5	24.0	28.5	-	-	46	51	8	-	28.5	33.0	EX1803.83.40	10
M50x1.5	33.0	37.0	-	-	55	57	9	-	37.0	42.0	EX1803.83.50	10
M63x1.5	40.0	46.0	-	-	70	60	10	-	46.0	52.0	EX1803.83.63	5

1 = Einteiliger Dichteinsatz

1 = One-piece sealing insert

2 = Zertifikat SEV 15 ATEX 0152X / IECEx SEV 15.0019X

2 = Certificate SEV 15 ATEX 0152X / IECEx SEV 15.0019X

Auf Anfrage lieferbar:

Available on request:

Anschlussgewinde Pg und NPT

Entry thread Pg and NPT

Ausführungen in Stahl A2 und A4

Executions in steel A2 and A4

**Langes Anschlussgewinde metrisch | Long entry thread metric**



Progress MS EMV easyCONNECT KB EX



Zweiteiliger Dichteinsatz  
 Nicht durchgehend isolierend

Two-piece sealing insert  
 not overall length insulated

G	>Ø1< min mm	>Ø1< max mm	>Ø1< min mm	>Ø1< max mm	mm	H mm	L mm	i info	>Ø1< min mm	>Ø1< max mm	Art.-No.	
M12x1.5	-	-	5.0	6.5	15/16	31	10	1/2	-	-	EX1813.83.12.065	50
M16x1.5	6.0	8.0	-	-	18/19	33	10	-	8.0	10.5	EX1813.83.17	50
M20x1.5	8.0	11.0	-	-	24	35	10	-	11.0	15.0	EX1813.83.20	50
M25x1.5	12.5	16.0	-	-	30	40	11	-	16.0	20.5	EX1813.83.25	25
M32x1.5	17.0	21.0	-	-	36	45	13	-	21.0	25.5	EX1813.83.32	25
M40x1.5	24.0	28.5	-	-	46	51	13	-	28.5	33.0	EX1813.83.40	10
M50x1.5	33.0	37.0	-	-	55	57	14	-	37.0	42.0	EX1813.83.50	10
M63x1.5	40.0	46.0	-	-	70	60	14	-	46.0	52.0	EX1813.83.63	5

1 = Einteiliger Dichteinsatz

1 = One-piece sealing insert

2 = Zertifikat SEV 15 ATEX 0152X / IECEx SEV 15.0019X

2 = Certificate SEV 15 ATEX 0152X / IECEx SEV 15.0019X

Auf Anfrage lieferbar:

Available on request:

Anschlussgewinde Pg und NPT

Entry thread Pg and NPT

Ausführungen in Stahl A2 und A4

Executions in steel A2 and A4

# AGRO Kombi-Schlauchverschraubungen Progress® Messing erhöhte Sicherheit Ex e II

## AGRO combination conduit glands Progress® nickel-plated brass increased safety Ex e II

### Kurzes Anschlussgewinde metrisch | Short entry thread metric

Material: Messing vernickelt  
 Dichtung: TPE  
 O-Ring: FPM  
 Schutzart: IP 66 / IP 68  
 Prüfnorm: IEC EN 60079-0 / IEC EN 60079-7 / IEC EN 60079-31  
 Gas: II 2G Ex eb IIC Gb  
 Staub: II 2D Ex tb IIIC Db  
 Zone: Gas 1 und 2 / Staub 21 und 22  
 Zertifikat: SEV 15 ATEX 0152X  
 IECEx Zertifikat: IECEx SEV 15.0019X  
 CCC Zertifikat: CCC 2022322313004811  
 Einsatztemperatur: -60 °C / +100 °C

Material: Nickel-plated brass  
 Seal: TPE  
 O-ring: FPM  
 Protection class: IP 66 / IP 68  
 Test standard: IEC EN 60079-0 / IEC EN 60079-7 / IEC EN 60079-31  
 Gas: II 2G Ex eb IIC Gb  
 Dust: II 2D Ex tb IIIC Db  
 Zone: Gas 1 and 2 / dust 21 and 22  
 Certificate: SEV 15 ATEX 0152X  
 IECEx Certificate: IECEx SEV 15.0019X  
 CCC Certificate: CCC 2022322313004811  
 Operation temperature: -60 °C / +100 °C

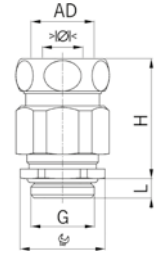

Einteiliger Dichteinsatz  
 Nicht durchgehend isolierend

One-piece sealing insert  
 not overall length insulated

G	AD mm	>Ø< min mm	>Ø< max mm	mm	H mm	L mm	Art.-No.	
M12x1.5	10	4.0	6.5	15/17	33	5	EX1700.12.10.065	50
M16x1.5	14	4.5	6.0	18/21	38	5	EX1700.17.14.060	50
M16x1.5	14	6.0	8.0	18/21	38	5	EX1700.17.14.080	50
M16x1.5	14	8.5	10.5	18/21	38	5	EX1700.17.14.105	50
M20x1.5	17	6.5	8.0	24/25	38	6	EX1700.20.17.080	25
M20x1.5	17	9.5	11.0	24/25	38	6	EX1700.20.17.110	25
M20x1.5	19	6.5	8.0	24/27	39	6	EX1700.20.19.080	25
M20x1.5	19	9.5	11.0	24/27	39	6	EX1700.20.19.110	25
M20x1.5	19	12.0	15.0	24/27	39	6	EX1700.20.19.150	25
M20x1.5	21	6.5	8.0	24/29	39	6	EX1700.20.21.080	25
M20x1.5	21	9.5	11.0	24/29	39	6	EX1700.20.21.110	25
M20x1.5	21	12.0	15.0	24/29	39	6	EX1700.20.21.150	25
M25x1.5	21	10.5	12.5	30/29	43	7	EX1700.25.21.125	25
M25x1.5	21	13.0	16.0	30/29	43	7	EX1700.25.21.160	25
M25x1.5	27	10.5	12.5	30/36	50	7	EX1700.25.27.125	25
M25x1.5	27	13.0	16.0	30/36	50	7	EX1700.25.27.160	25
M25x1.5	27	17.0	20.5	30/36	50	7	EX1700.25.27.205	25
M32x1.5	27	19.0	21.0	36/36	52	8	EX1700.32.27.210	25
M40x1.5	36	25.0	28.5	45/45	56	8	EX1700.40.36.285	10
M50x1.5	45	35.0	37.0	55/54	60	9	EX1700.50.45.370	10
M63x1.5	56	44.0	46.0	70/66	67	10	EX1700.63.56.460	5



Progress MS Kombi EX



Langes Anschlussgewinde auf Anfrage

Long entry thread available on request

Je nach Schlauchtyp muss die passende Stabilisierungshülse separat bestellt werden.

Depending on the type of conduit, the stabilising bush must be ordered separately.

Achtung: Es dürfen nur metallische oder metallisch umflochtene Schutzschläuche verwendet werden !

Warning: Only metallic conduits or conduits with metallic braiding may be applied !

# Druckausgleichselement mit Membrane erhöhte Sicherheit Ex e II

## Pressure balance element with membrane increased safety Ex e II

### Anschlussgewinde metrisch | Entry thread metric

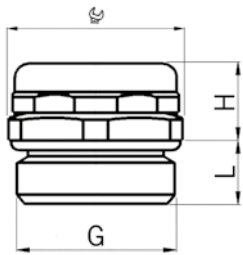

Material: Messing vernickelt  
 Membrane: PTFE (Polyterafuorethylen) frei von PFOA und PFOS  
 O-Ring: FPM  
 Schutzart: IP 66 / IP 68 / IP 69  
 Prüfnorm: IEC EN 60079-0 / IEC EN 60079-7 / IEC EN 60079-31  
 Gas: II 2G Ex eb IIC Gb  
 Staub: II 2D Ex tb IIIC Db  
 Zone: Gas 1 und 2 / Staub 21 und 22  
 Zertifikat: SEV 16 ATEX 0143  
 IECEx Zertifikat: IECEx SEV 16.0010  
 Einsatztemperatur: -60 °C / +100 °C

Material: Nickel-plated brass  
 Membrane: PTFE (polyterafuorethylene) free from PFOA and PFOS  
 O-ring: FPM  
 Protection class: IP 66 / IP 68 / IP 69  
 Test standard: IEC EN 60079-0 / IEC EN 60079-7 / IEC EN 60079-31  
 Gas: II 2G Ex eb IIC Gb  
 Dust: II 2D Ex tb IIIC Db  
 Zone: Gas 1 and 2 / dust 21 and 22  
 Certificate: SEV 16 ATEX 0143  
 IECEx Certificate: IECEx SEV 16.0010  
 Operation temperature: -60 °C / +100 °C



EX DAE



Mit Membrane  
Mit O-Ring

with membrane  
with O-ring

G	$\frac{H}{L}$ mm	H mm	L mm	Art.-No.	
M12x1.5	18	9.5	8	EX2450.12.34	25
M16x1.5	18	9.5	8	EX2450.17.34	20
M20x1.5	22	10.0	8	EX2450.20.34	20

Auf Anfrage lieferbar:

Available on request:

Rostfreier Stahl A2 oder A4

Stainless steel A2 or A4

### Verschlussbolzen für Multi-Kabelverschraubungen | Locking pin for multi cable glands

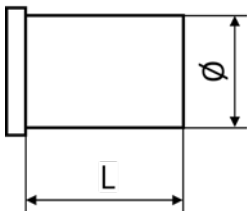

Material: Messing vernickelt  
 Einsatzbereich: Zum Verschliessen nicht belegter Bohrungen in Mehrfach-Kabelverschraubungen  
 Einsatztemperatur: -60 °C / +100 °C

Material: Nickel-plated brass  
 Application: Usable as inserts to close unused holes in sealings of multi-duct cable glands  
 Operation temperature: -60 °C / +100 °C



Verschlussbolzen zu Kabelverschraubungen

Locking pins for cable glands

$>\frac{\text{Ø}}{L}$ mm mm	Art.-No.	
1.5 6	EX1310.015.07	25
3 7	EX1310.030.07	25
4 7	EX1310.040.07	25
5 7	EX1310.050.07	25
6 7	EX1310.060.07	25
7 7	EX1310.070.07	25
9 9	EX1310.090.07	25
10 9	EX1310.100.07	25
12 11	EX1310.120.07	25
15 11	EX1310.150.07	25
18 12	EX1310.180.07	25

Einsetzbar auch für Ex Multi-Kabelverschraubungen

Can also be used for Ex multi cable glands

# AGRO Kabelverschraubungen Progress® Kunststoff GFK erhöhte Sicherheit Ex e II

## AGRO synthetic cable glands Progress® GFK increased safety Ex e II

### Anschlussgewinde metrisch | Entry thread metric

Material:	Polyamid glasfaserverstärkt	Material:	Polyamide glass fiber reinforced
Eigenschaften:	halogenfrei	Properties:	halogen-free
Dichtung:	TPE / NBR	Seal:	TPE / NBR
Schutzart:	IP 66 / IP 68	Protection class:	IP 66 / IP 68
Prüfnorm:	IEC EN 60079-0 / IEC EN 60079-7 / IEC EN 60079-31	Test standard:	IEC EN 60079-0 / IEC EN 60079-7 / IEC EN 60079-31
Gas:	II 2G Ex eb IIC Gb	Gas:	II 2G Ex eb IIC Gb
Staub:	II 2D Ex tb IIIC Db	Dust:	II 2D Ex tb IIIC Db
Zone:	Gas 1 und 2 / Staub 21 und 22	Zone:	Gas 1 and 2 / dust 21 and 22
Zertifikat:	SEV 15 ATEX 0152X	Certificate:	SEV 15 ATEX 0152X
IECEX Zertifikat:	IECEX SEV 15.0019X	IECEX Certificate:	IECEX SEV 15.0019X
CCC Zertifikat:	CCC 2022322313004811	CCC Certificate:	CCC 2022322313004811
Einsatztemperatur:	-20 °C / +85 °C	Operation temperature:	-20 °C / +85 °C

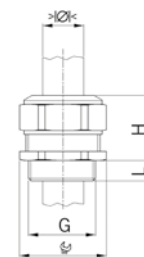

Hellgrau RAL 7035  
Einteiliger Dichteinsatz

Light grey RAL 7035  
One-piece sealing insert

G	>math>D_k</math> min mm	>math>D_k</math> max mm	H mm	L mm	i info	Art.-No.	Box	
M16x1.5	4.5	6.0	21	26	12	-	EX1571.17.060	50
M16x1.5	6.0	8.0	21	26	12	-	EX1571.17.080	50
M20x1.5	6.0	8.0	27	28	13	-	EX1571.20.080	50
M20x1.5	8.0	11.0	27	28	13	-	EX1571.20.110	50
M25x1.5	9.5	12.5	34	33	13	-	EX1571.25.125	25
M25x1.5	12.5	16.0	34	33	13	-	EX1571.25.160	25
M25x1.5	16.0	19.0	34	33	13	-	EX1571.25.190	25
M25x1.5	19.0	20.5	34	33	13	-	EX1571.25.205	25
M32x1.5	20.0	21.0	41	35	15	-	EX1571.32.210	25
M32x1.5	21.0	22.0	41	35	15	3	EX1571.32.220	25
M32x1.5	22.0	23.0	41	35	15	3	EX1571.32.230	25
M32x1.5	23.0	25.5	41	35	15	-	EX1571.32.255	25
M40x1.5	25.5	27.0	50	40	15	3	EX1571.40.270	10
M40x1.5	27.0	28.5	50	40	15	-	EX1571.40.285	10
M40x1.5	28.5	30.0	50	40	15	3	EX1571.40.300	10
M40x1.5	30.0	33.0	50	40	15	-	EX1571.40.330	10
M50x1.5	33.0	35.0	60	42	16	3	EX1571.50.350	10
M50x1.5	35.0	37.0	60	42	16	-	EX1571.50.370	10
M50x1.5	37.0	39.0	60	42	16	3	EX1571.50.390	10
M50x1.5	39.0	42.0	60	42	16	-	EX1571.50.420	10
M63x1.5	42.0	44.0	75	48	16	3	EX1571.63.440	5
M63x1.5	44.0	46.0	75	48	16	-	EX1571.63.460	5
M63x1.5	46.0	48.0	75	48	16	3	EX1571.63.480	5
M63x1.5	48.0	52.0	75	48	16	-	EX1571.63.520	5

3 = Material Dichteinsatz NBR

3 = Material sealing insert NBR



Progress GFK EX



# AGRO Kabelverschraubungen Progress® Kunststoff GFK erhöhte Sicherheit Ex e II

## AGRO synthetic cable glands Progress® GFK increased safety Ex e II

### Anschlussgewinde metrisch | Entry thread metric

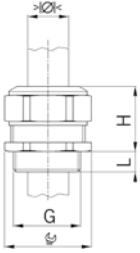

Material: Polyamid  
glasfaserverstärkt

Eigenschaften: halogenfrei

Dichtung: TPE / NBR

Schutzart: IP 66 / IP 68

Prüfnorm: IEC EN 60079-0 /  
IEC EN 60079-7 /  
IEC EN 60079-31

Gas: II 2G Ex eb IIC Gb

Staub: II 2D Ex tb IIIC Db

Zone: Gas 1 und 2 /  
Staub 21 und 22

Zertifikat: SEV 15 ATEX 0152X

IECEX Zertifikat: IECEX SEV 15.0019X

CCC Zertifikat: CCC 2022322313004811

Einsatztemperatur: -20 °C / +85 °C

Material: Polyamide  
glass fiber reinforced

Properties: halogen-free

Seal: TPE / NBR

Protection class: IP 66 / IP 68

Test standard: IEC EN 60079-0 /  
IEC EN 60079-7 /  
IEC EN 60079-31

Gas: II 2G Ex eb IIC Gb

Dust: II 2D Ex tb IIIC Db

Zone: Gas 1 and 2 /  
dust 21 and 22

Certificate: SEV 15 ATEX 0152X

IECEX Certificate: IECEX SEV 15.0019X

CCC Certificate: CCC 2022322313004811

Operation temperature: -20 °C / +85 °C



Progress GFK EX



Schwarz RAL 9005  
Einteiliger Dichteinsatz

Black RAL 9005  
One-piece sealing insert

G	> Ø <	> Ø <	Ø	H	L	i	Art.-No.	
	min mm	max mm	mm	mm	mm	info		
M16x1.5	4.5	6.0	21	26	12	-	EX1540.17.060	50
M16x1.5	6.0	8.0	21	26	12	-	EX1540.17.080	50
M20x1.5	6.0	8.0	27	28	13	-	EX1540.20.080	50
M20x1.5	8.0	11.0	27	28	13	-	EX1540.20.110	50
M25x1.5	9.5	12.5	34	33	13	-	EX1540.25.125	25
M25x1.5	12.5	16.0	34	33	13	-	EX1540.25.160	25
M25x1.5	16.0	19.0	34	33	13	-	EX1540.25.190	25
M25x1.5	19.0	20.5	34	33	13	-	EX1540.25.205	25
M32x1.5	20.0	21.0	41	35	15	-	EX1540.32.210	25
M32x1.5	21.0	22.0	41	35	15	3	EX1540.32.220	25
M32x1.5	22.0	23.0	41	35	15	3	EX1540.32.230	25
M32x1.5	23.0	25.5	41	35	15	-	EX1540.32.255	25
M40x1.5	25.5	27.0	50	40	15	3	EX1540.40.270	10
M40x1.5	27.0	28.5	50	40	15	-	EX1540.40.285	10
M40x1.5	28.5	30.0	50	40	15	3	EX1540.40.300	10
M40x1.5	30.0	33.0	50	40	15	-	EX1540.40.330	10
M50x1.5	33.0	35.0	60	42	16	3	EX1540.50.350	10
M50x1.5	35.0	37.0	60	42	16	-	EX1540.50.370	10
M50x1.5	37.0	39.0	60	42	16	3	EX1540.50.390	10
M50x1.5	39.0	42.0	60	42	16	-	EX1540.50.420	10
M63x1.5	42.0	44.0	75	48	16	3	EX1540.63.440	5
M63x1.5	44.0	46.0	75	48	16	-	EX1540.63.460	5
M63x1.5	46.0	48.0	75	48	16	3	EX1540.63.480	5
M63x1.5	48.0	52.0	75	48	16	-	EX1540.63.520	5

3 = Material Dichteinsatz NBR

3 = Material sealing insert NBR

# AGRO Kabelverschraubungen Progress® Kunststoff GFK erhöhte Sicherheit Ex e II

## AGRO synthetic cable glands Progress® GFK increased safety Ex e II

### Anschlussgewinde Pg | Entry thread Pg

Material: Polyamid  
glasfaserverstärkt

Eigenschaften: halogenfrei

Dichtung: TPE / NBR

Schutzart: IP 66 / IP 68

Prüfnorm: IEC EN 60079-0 /  
IEC EN 60079-7 /  
IEC EN 60079-31

Gas: II 2G Ex eb IIC Gb

Staub: II 2D Ex tb IIIC Db

Zone: Gas 1 und 2 /  
Staub 21 und 22

Zertifikat: SEV 15 ATEX 0152X

IECEX Zertifikat: IECEX SEV 15.0019X

CCC Zertifikat: CCC 2022322313004811

Einsatztemperatur: -20 °C / +85 °C

Material: Polyamide  
glass fiber reinforced

Properties: halogen-free

Seal: TPE / NBR

Protection class: IP 66 / IP 68

Test standard: IEC EN 60079-0 /  
IEC EN 60079-7 /  
IEC EN 60079-31

Gas: II 2G Ex eb IIC Gb

Dust: II 2D Ex tb IIIC Db

Zone: Gas 1 and 2 /  
dust 21 and 22

Certificate: SEV 15 ATEX 0152X

IECEX Certificate: IECEX SEV 15.0019X

CCC Certificate: CCC 2022322313004811

Operation temperature: -20 °C / +85 °C

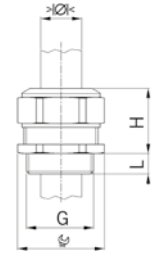

Hellgrau RAL 7035  
Einteiliger Dichteinsatz

Light grey RAL 7035  
One-piece sealing insert

G	>Ø<	>Ø<	Ø	H	L	i	Art.-No.	
	min mm	max mm	mm	mm	mm	info		
Pg 9	4.5	6.0	21	26	12	-	EX1571.09.060	50
Pg 9	6.0	8.0	21	26	12	-	EX1571.09.080	50
Pg 11	4.0	5.5	24	28	12	-	EX1571.11.055	50
Pg 11	5.5	8.5	24	28	12	-	EX1571.11.085	50
Pg 13	6.0	8.0	27	28	13	-	EX1571.13.080	50
Pg 13	8.0	11.0	27	28	13	-	EX1571.13.110	50
Pg 16	6.0	8.0	27	28	13	-	EX1571.16.080	50
Pg 16	8.0	11.0	27	28	13	-	EX1571.16.110	50
Pg 21	9.5	12.5	34	33	13	-	EX1571.21.125	25
Pg 21	12.5	16.0	34	33	13	-	EX1571.21.160	25
Pg 21	16.0	19.0	34	33	13	-	EX1571.21.190	25
Pg 21	19.0	20.5	34	33	13	-	EX1571.21.205	25
Pg 29	19.5	21.0	41	36	13	3	EX1571.29.210	25
Pg 29	21.0	23.0	41	36	13	-	EX1571.29.230	25
Pg 29	23.0	25.0	41	36	13	3	EX1571.29.250	25
Pg 29	25.0	27.5	41	36	13	-	EX1571.29.275	25
Pg 36	27.0	28.5	55	42	16	3	EX1571.36.285	10
Pg 36	28.5	30.5	55	42	16	-	EX1571.36.305	10
Pg 36	30.5	32.5	55	42	16	3	EX1571.36.325	10
Pg 36	32.5	35.0	55	42	16	-	EX1571.36.350	10
Pg 42	33.0	35.0	60	42	16	3	EX1571.42.350	10
Pg 42	35.0	37.0	60	42	16	-	EX1571.42.370	10
Pg 42	37.0	39.0	60	42	16	3	EX1571.42.390	10
Pg 42	39.0	42.0	60	42	16	-	EX1571.42.420	10
Pg 48	41.0	43.0	70	46	16	-	EX1571.48.430	5
Pg 48	43.0	45.0	70	46	16	3	EX1571.48.450	5
Pg 48	45.0	47.0	70	46	16	3	EX1571.48.470	5
Pg 48	47.0	49.0	70	46	16	-	EX1571.48.490	5

3 = Material Dichteinsatz NBR

3 = Material sealing insert NBR



Progress GFK EX



### Anschlussgewinde Pg | Entry thread Pg

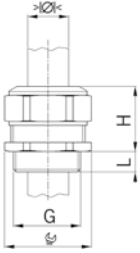

Material: Polyamid  
glasfaserverstärkt

Eigenschaften: halogenfrei

Dichtung: TPE / NBR

Schutzart: IP 66 / IP 68

Prüfnorm: IEC EN 60079-0 /  
IEC EN 60079-7 /  
IEC EN 60079-31

Gas: II 2G Ex eb IIC Gb

Staub: II 2D Ex tb IIIC Db

Zone: Gas 1 und 2 /  
Staub 21 und 22

Zertifikat: SEV 15 ATEX 0152X

IECEX Zertifikat: IECEX SEV 15.0019X

CCC Zertifikat: CCC 2022322313004811

Einsatztemperatur: -20 °C / +85 °C

Material: Polyamide  
glass fiber reinforced

Properties: halogen-free

Seal: TPE / NBR

Protection class: IP 66 / IP 68

Test standard: IEC EN 60079-0 /  
IEC EN 60079-7 /  
IEC EN 60079-31

Gas: II 2G Ex eb IIC Gb

Dust: II 2D Ex tb IIIC Db

Zone: Gas 1 and 2 /  
dust 21 and 22

Certificate: SEV 15 ATEX 0152X

IECEX Certificate: IECEX SEV 15.0019X

CCC Certificate: CCC 2022322313004811

Operation temperature: -20 °C / +85 °C



Progress GFK EX



Schwarz RAL 9005  
Einteiliger Dichteinsatz

Black RAL 9005  
One-piece sealing insert

G	>Øk min mm	>Øk max mm	mm	H mm	L mm	i info	Art.-No.	
Pg 9	4.5	6.0	21	26	12	-	EX1540.09.060	50
Pg 9	6.0	8.0	21	26	12	-	EX1540.09.080	50
Pg 11	4.0	5.5	24	28	12	-	EX1540.11.055	50
Pg 11	5.5	8.5	24	28	12	-	EX1540.11.085	50
Pg 13	6.0	8.0	27	28	13	-	EX1540.13.080	50
Pg 13	8.0	11.0	27	28	13	-	EX1540.13.110	50
Pg 16	6.0	8.0	27	28	13	-	EX1540.16.080	50
Pg 16	8.0	11.0	27	28	13	-	EX1540.16.110	50
Pg 21	9.5	12.5	34	33	13	-	EX1540.21.125	25
Pg 21	12.5	16.0	34	33	13	-	EX1540.21.160	25
Pg 21	16.0	19.0	34	33	13	-	EX1540.21.190	25
Pg 21	19.0	20.5	34	33	13	-	EX1540.21.205	25
Pg 29	19.5	21.0	41	36	13	3	EX1540.29.210	25
Pg 29	21.0	23.0	41	36	13	-	EX1540.29.230	25
Pg 29	23.0	25.0	41	36	13	3	EX1540.29.250	25
Pg 29	25.0	27.5	41	36	13	-	EX1540.29.275	25
Pg 36	27.0	28.5	55	42	16	3	EX1540.36.285	10
Pg 36	28.5	30.5	55	42	16	-	EX1540.36.305	10
Pg 36	30.5	32.5	55	42	16	3	EX1540.36.325	10
Pg 36	32.5	35.0	55	42	16	-	EX1540.36.350	10
Pg 42	33.0	35.0	60	42	16	3	EX1540.42.350	10
Pg 42	35.0	37.0	60	42	16	-	EX1540.42.370	10
Pg 42	37.0	39.0	60	42	16	3	EX1540.42.390	10
Pg 42	39.0	42.0	60	42	16	-	EX1540.42.420	10
Pg 48	41.0	43.0	70	46	16	-	EX1540.48.430	5
Pg 48	43.0	45.0	70	46	16	3	EX1540.48.450	5
Pg 48	45.0	47.0	70	46	16	3	EX1540.48.470	5
Pg 48	47.0	49.0	70	46	16	-	EX1540.48.490	5

3 = Material Dichteinsatz NBR

3 = Material sealing insert NBR

Anschlussgewinde metrisch | Entry thread metric

Material: Polyamid  
glasfaserverstärkt  
Eigenschaften: halogenfrei  
Dichtung: TPE / NBR  
Schutzart: IP 66 / IP 68  
Prüfnorm: IEC EN 60079-0 /  
IEC EN 60079-7 /  
IEC EN 60079-31  
Gas: II 2G Ex eb IIC Gb  
Staub: II 2D Ex tb IIIC Db  
Zone: Gas 1 und 2 /  
Staub 21 und 22  
Zertifikat: SEV 15 ATEX 0152X  
IECEX Zertifikat: IECEX SEV 15.0019X  
CCC Zertifikat: CCC 2022322313004811  
Einsatztemperatur: -20 °C / +85 °C

Material: Polyamide  
glass fiber reinforced  
Properties: halogen-free  
Seal: TPE / NBR  
Protection class: IP 66 / IP 68  
Test standard: IEC EN 60079-0 /  
IEC EN 60079-7 /  
IEC EN 60079-31  
Gas: II 2G Ex eb IIC Gb  
Dust: II 2D Ex tb IIIC Db  
Zone: Gas 1 and 2 /  
dust 21 and 22  
Certificate: SEV 15 ATEX 0152X  
IECEX Certificate: IECEX SEV 15.0019X  
CCC Certificate: CCC 2022322313004811  
Operation temperature: -20 °C / +85 °C

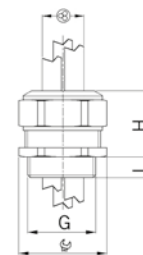

Hellgrau RAL 7035 Einteiliger Dichteinsatz		Light grey RAL 7035 One-piece sealing insert							
G	$\begin{matrix} >10k \\ \text{min mm} \end{matrix}$	$\begin{matrix} >10k \\ \text{max mm} \end{matrix}$	$\begin{matrix} \text{mm} \\ \text{mm} \end{matrix}$	H	L	i	Art.-No.		
M16x1.5	1.0	1.5	4	21	26	12	3	EX1571.17.4.015	50
M16x1.5	2.0	3.0	2	21	26	12	-	EX1571.17.2.030	50
M20x1.5	2.5	3.0	6	27	28	13	-	EX1571.20.6.030	50
M20x1.5	3.5	5.0	2	27	28	13	-	EX1571.20.2.050	50
M25x1.5	5.0	6.0	6	34	33	13	-	EX1571.25.6.060	25
M25x1.5	5.5	7.0	4	34	33	13	-	EX1571.25.4.070	25
M25x1.5	7.5	9.0	3	34	33	13	-	EX1571.25.3.090	25
M25x1.5	8.0	10.0	2	34	33	13	-	EX1571.25.2.100	25
M32x1.5	6.0	7.0	6	41	35	15	-	EX1571.32.6.070	25
M32x1.5	7.5	9.0	4	41	35	15	-	EX1571.32.4.090	25
M40x1.5	8.0	9.0	7	50	40	15	3	EX1571.40.7.090	10
M40x1.5	14.0	15.0	2	50	40	15	3	EX1571.40.2.150	10
M50x1.5	9.0	10.0	4	60	42	16	3	EX1571.50.4.100	10
M63x1.5	11.0	12.0	6	75	48	16	3	EX1571.63.6.120	5
M63x1.5	17.0	18.0	3	75	48	16	3	EX1571.63.3.180	5

3 = Material Dichteinsatz NBR  
Passende Verschlussbolzen siehe Zubehör

3 = Material sealing insert NBR  
Suitable locking pins see accessories



Progress GFK  
Multi EX



Schwarz RAL 9005 Einteiliger Dichteinsatz		Black RAL 9005 One-piece sealing insert							
G	$\begin{matrix} >10k \\ \text{min mm} \end{matrix}$	$\begin{matrix} >10k \\ \text{max mm} \end{matrix}$	$\begin{matrix} \text{mm} \\ \text{mm} \end{matrix}$	H	L	i	Art.-No.		
M16x1.5	1.0	1.5	4	21	26	12	3	EX1540.17.4.015	50
M16x1.5	2.0	3.0	2	21	26	12	-	EX1540.17.2.030	50
M20x1.5	2.5	3.0	6	27	28	13	-	EX1540.20.6.030	50
M20x1.5	3.5	5.0	2	27	28	13	-	EX1540.20.2.050	50
M25x1.5	5.0	6.0	6	34	33	13	-	EX1540.25.6.060	25
M25x1.5	5.5	7.0	4	34	33	13	-	EX1540.25.4.070	25
M25x1.5	7.5	9.0	3	34	33	13	-	EX1540.25.3.090	25
M25x1.5	8.0	10.0	2	34	33	13	-	EX1540.25.2.100	25
M32x1.5	6.0	7.0	6	41	33	13	-	EX1540.32.6.070	25
M32x1.5	7.5	9.0	4	41	35	15	-	EX1540.32.4.090	25
M40x1.5	8.0	9.0	7	50	40	15	3	EX1540.40.7.090	10
M40x1.5	14.0	15.0	2	50	40	15	3	EX1540.40.2.150	10
M50x1.5	9.0	10.0	4	60	42	16	3	EX1540.50.4.100	10
M63x1.5	11.0	12.0	6	75	48	16	3	EX1540.63.6.120	5
M63x1.5	17.0	18.0	3	75	48	16	3	EX1540.63.3.180	5

3 = Material Dichteinsatz NBR  
Passende Verschlussbolzen siehe Zubehör

3 = Material sealing insert NBR  
Suitable locking pins see accessories



Progress GFK  
Multi EX



**Anschlussgewinde Pg | Entry thread Pg**

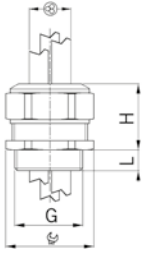

Material: Polyamid  
glasfaserverstärkt  
Eigenschaften: halogenfrei  
Dichtung: TPE / NBR  
Schutzart: IP 66 / IP 68  
Prüfnorm: IEC EN 60079-0 /  
IEC EN 60079-7 /  
IEC EN 60079-31  
Gas: II 2G Ex eb IIC Gb  
Staub: II 2D Ex tb IIIC Db  
Zone: Gas 1 und 2 /  
Staub 21 und 22  
Zertifikat: SEV 15 ATEX 0152X  
IECEX Zertifikat: IECEX SEV 15.0019X  
CCC Zertifikat: CCC 2022322313004811  
Einsatztemperatur: -20 °C / +85 °C

Material: Polyamide  
glass fiber reinforced  
Properties: halogen-free  
Seal: TPE / NBR  
Protection class: IP 66 / IP 68  
Test standard: IEC EN 60079-0 /  
IEC EN 60079-7 /  
IEC EN 60079-31  
Gas: II 2G Ex eb IIC Gb  
Dust: II 2D Ex tb IIIC Db  
Zone: Gas 1 and 2 /  
dust 21 and 22  
Certificate: SEV 15 ATEX 0152X  
IECEX Certificate: IECEX SEV 15.0019X  
CCC Certificate: CCC 2022322313004811  
Operation temperature: -20 °C / +85 °C



Progress GFK  
Multi EX



Hellgrau RAL 7035  
Einteiliger Dichteinsatz

Light grey RAL 7035  
One-piece sealing insert

G	>Øk min mm	>Øk max mm	⊗ mm	Ⓜ mm	H mm	L mm	i info	Art.-No.	
Pg 9	1.0	1.5	4	21	26	12	3	EX1571.09.4.015	50
Pg 9	2.0	3.0	2	21	26	12	-	EX1571.09.2.030	50
Pg 11	3.5	5.0	2	24	28	12	-	EX1571.11.2.050	50
Pg 11	2.0	3.0	3	24	28	12	3	EX1571.11.3.030	50
Pg 13	2.5	4.0	3	27	28	13	3	EX1571.13.3.040	50
Pg 13	3.5	5.0	2	27	28	13	-	EX1571.13.2.050	50
Pg 16	2.5	3.0	6	27	28	13	-	EX1571.16.6.030	50
Pg 16	4.5	6.0	3	27	28	13	-	EX1571.16.3.060	50
Pg 21	5.5	7.0	4	34	33	13	-	EX1571.21.4.070	25
Pg 21	7.5	9.0	3	34	33	13	-	EX1571.21.3.090	25
Pg 29	5.5	6.5	6	41	36	13	3	EX1571.29.6.065	25
Pg 29	8.0	9.0	3	41	36	13	3	EX1571.29.3.090	25
Pg 36	9.0	10.0	4	55	42	16	3	EX1571.36.4.100	10
Pg 36	14.0	15.0	2	55	42	16	3	EX1571.36.2.150	10
Pg 42	9.0	10.0	4	60	42	16	3	EX1571.42.4.100	10
Pg 48	11.0	12.0	6	70	46	16	3	EX1571.48.6.120	5
Pg 48	17.0	18.0	3	70	46	16	3	EX1571.48.3.180	5

3 = Material Dichteinsatz NBR

3 = Material sealing insert NBR

**Anschlussgewinde Pg | Entry thread Pg**

Material: Polyamid  
glasfaserverstärkt  
Eigenschaften: halogenfrei  
Dichtung: TPE / NBR  
Schutzart: IP 66 / IP 68  
Prüfnorm: IEC EN 60079-0 /  
IEC EN 60079-7 /  
IEC EN 60079-31  
Gas: II 2G Ex eb IIC Gb  
Staub: II 2D Ex tb IIIC Db  
Zone: Gas 1 und 2 /  
Staub 21 und 22  
Zertifikat: SEV 15 ATEX 0152X  
IECEX Zertifikat: IECEX SEV 15.0019X  
CCC Zertifikat: CCC 2022322313004811  
Einsatztemperatur: -20 °C / +85 °C

Material: Polyamide  
glass fiber reinforced  
Properties: halogen-free  
Seal: TPE / NBR  
Protection class: IP 66 / IP 68  
Test standard: IEC EN 60079-0 /  
IEC EN 60079-7 /  
IEC EN 60079-31  
Gas: II 2G Ex eb IIC Gb  
Dust: II 2D Ex tb IIIC Db  
Zone: Gas 1 and 2 /  
dust 21 and 22  
Certificate: SEV 15 ATEX 0152X  
IECEX Certificate: IECEX SEV 15.0019X  
CCC Certificate: CCC 2022322313004811  
Operation temperature: -20 °C / +85 °C

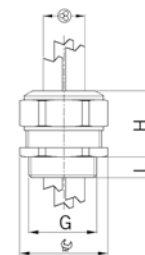

Schwarz RAL 9005  
Einteiliger Dichteinsatz

Black RAL 9005  
One-piece sealing insert

G	>Øk min mm	>Øk max mm	⊗ mm	Ⓜ mm	H mm	L mm	i info	Art.-No.	
Pg 9	1.0	1.5	4	21	26	12	3	EX1540.09.4.015	50
Pg 9	2.0	3.0	2	21	26	12	-	EX1540.09.2.030	50
Pg 11	2.0	3.0	3	24	28	12	3	EX1540.11.3.030	50
Pg 11	3.5	5.0	2	24	28	12	-	EX1540.11.2.050	50
Pg 13	2.5	4.0	3	27	28	13	3	EX1540.13.3.040	50
Pg 13	3.5	5.0	2	27	28	13	-	EX1540.13.2.050	50
Pg 16	2.5	3.0	6	27	28	13	-	EX1540.16.6.030	50
Pg 16	4.5	6.0	3	27	28	13	-	EX1540.16.3.060	50
Pg 21	5.5	7.0	4	34	33	13	-	EX1540.21.4.070	25
Pg 21	7.5	9.0	3	34	33	13	-	EX1540.21.3.090	25
Pg 29	5.5	6.5	6	41	36	13	3	EX1540.29.6.065	25
Pg 29	8.0	9.0	3	41	36	13	3	EX1540.29.3.090	25
Pg 36	14.0	15.0	2	55	42	16	3	EX1540.36.2.150	10
Pg 36	9.0	10.0	4	55	42	16	3	EX1540.36.4.100	10
Pg 42	9.0	10.0	4	60	42	16	3	EX1540.42.4.100	10
Pg 48	11.0	12.0	6	70	46	16	3	EX1540.48.6.120	5
Pg 48	17.0	18.0	3	70	46	16	3	EX1540.48.3.180	5

3 = Material Dichteinsatz NBR

3 = Material sealing insert NBR



Progress GFK  
Multi EX



**Anschlussgewinde metrisch | Entry thread metric**

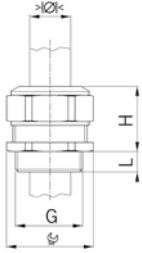

Material: Polyamid  
glasfaserverstärkt  
Eigenschaften: halogenfrei  
Dichtung: TPE / NBR  
Schutzart: IP 66 / IP 68  
Prüfnorm: IEC EN 60079-0 /  
IEC EN 60079-7 /  
IEC EN 60079-31  
Gas: II 2G Ex eb IIC Gb  
Staub: II 2D Ex tb IIIC Db  
Eigensicherheit Gas: II 2G Ex ia IIC Ga  
Eigensicherheit Staub: II 2D Ex ia IIIC Da  
Zone: Gas 0, 1 und 2 /  
Staub 20, 21 und 22  
Zertifikat: SEV 15 ATEX 0152X  
IECEX Zertifikat: IECEX SEV 15.0019X  
CCC Zertifikat: CCC 2022322313004811  
Einsatztemperatur: -20 °C / +85 °C

Material: Polyamide  
glass fiber reinforced  
Properties: halogen-free  
Seal: TPE / NBR  
Protection class: IP 66 / IP 68  
Test standard: IEC EN 60079-0 /  
IEC EN 60079-7 /  
IEC EN 60079-31  
Gas: II 2G Ex eb IIC Gb  
Dust: II 2D Ex tb IIIC Db  
Intrinsic safety gas: II 2G Ex ia IIC Ga  
Intrinsic safety dust: II 2D Ex ia IIIC Da  
Zone: Gas 0, 1 and 2 /  
dust 20, 21 and 22  
Certificate: SEV 15 ATEX 0152X  
IECEX Certificate: IECEX SEV 15.0019X  
CCC Certificate: CCC 2022322313004811  
Operation temperature: -20 °C / +85 °C



Progress GFK EX



Schwarz / Lichtblau RAL 5012  
Einteiliger Dichteinsatz

Black / light blue RAL 5012  
One-piece sealing insert

G	> < <	> < <		H	L	i	Art.-No.	
	min mm	max mm	mm	mm	mm	info		
M16x1.5	4.5	6.0	21	26	12	-	EX1530.17.060	50
M16x1.5	6.0	8.0	21	26	12	-	EX1530.17.080	50
M20x1.5	6.0	8.0	27	28	13	-	EX1530.20.080	50
M20x1.5	8.0	11.0	27	28	13	-	EX1530.20.110	50
M25x1.5	9.5	12.5	34	33	13	-	EX1530.25.125	25
M25x1.5	12.5	16.0	34	33	13	-	EX1530.25.160	25
M25x1.5	16.0	19.0	34	33	13	-	EX1530.25.190	25
M25x1.5	19.0	20.5	34	33	13	-	EX1530.25.205	25
M32x1.5	20.0	21.0	41	35	15	-	EX1530.32.210	25
M32x1.5	21.0	22.0	41	35	15	3	EX1530.32.220	25
M32x1.5	22.0	23.0	41	35	15	3	EX1530.32.230	25
M32x1.5	23.0	25.5	41	35	15	-	EX1530.32.255	25
M40x1.5	25.5	27.0	50	40	15	3	EX1530.40.270	10
M40x1.5	27.0	28.5	50	40	15	-	EX1530.40.285	10
M40x1.5	28.5	30.0	50	40	15	3	EX1530.40.300	10
M40x1.5	30.0	33.0	50	40	15	-	EX1530.40.330	10
M50x1.5	33.0	35.0	60	42	16	3	EX1530.50.350	10
M50x1.5	35.0	37.0	60	42	16	-	EX1530.50.370	10
M50x1.5	37.0	39.0	60	42	16	3	EX1530.50.390	10
M50x1.5	39.0	42.0	60	42	16	-	EX1530.50.420	10
M63x1.5	42.0	44.0	75	48	16	3	EX1530.63.440	5
M63x1.5	44.0	46.0	75	48	16	-	EX1530.63.460	5
M63x1.5	46.0	48.0	75	48	16	3	EX1530.63.480	5
M63x1.5	48.0	52.0	75	48	16	-	EX1530.63.520	5

3 = Material Dichteinsatz NBR

3 = Material sealing insert NBR

Auf Anfrage lieferbar:

Available on request:

Für mehrere Kabel

For installation of multiple cables

**Anschlussgewinde Pg | Entry thread Pg**

Material: Polyamid  
glasfaserverstärkt  
Eigenschaften: halogenfrei  
Dichtung: TPE / NBR  
Schutzart: IP 66 / IP 68  
Prüfnorm: IEC EN 60079-0 /  
IEC EN 60079-7 /  
IEC EN 60079-31  
Gas: II 2G Ex eb IIC Gb  
Staub: II 2D Ex tb IIIC Db  
Eigensicherheit Gas: II 2G Ex ia IIC Ga  
Eigensicherheit Staub: II 2D Ex ia IIIC Da  
Zone: Gas 0, 1 und 2 /  
Staub 20, 21 und 22  
Zertifikat: SEV 15 ATEX 0152X  
IECEX Zertifikat: IECEX SEV 15.0019X  
CCC Zertifikat: CCC 2022322313004811  
Einsatztemperatur: -20 °C / +85 °C

Material: Polyamide  
glass fiber reinforced  
Properties: halogen-free  
Seal: TPE / NBR  
Protection class: IP 66 / IP 68  
Test standard: IEC EN 60079-0 /  
IEC EN 60079-7 /  
IEC EN 60079-31  
Gas: II 2G Ex eb IIC Gb  
Dust: II 2D Ex tb IIIC Db  
Intrinsic safety gas: II 2G Ex ia IIC Ga  
Intrinsic safety dust: II 2D Ex ia IIIC Da  
Zone: Gas 0, 1 and 2 /  
dust 20, 21 and 22  
Certificate: SEV 15 ATEX 0152X  
IECEX Certificate: IECEX SEV 15.0019X  
CCC Certificate: CCC 2022322313004811  
Operation temperature: -20 °C / +85 °C

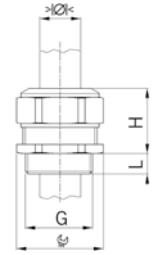

Schwarz / Lichtblau RAL 5012  
Einteiliger Dichteinsatz

Black / light blue RAL 5012  
One-piece sealing insert

G	>Ø< min mm	>Ø< max mm	 mm	H mm	L mm	i info	Art.-No.	
Pg 9	4.5	6.0	21	26	12	-	EX1530.09.060	50
Pg 9	6.0	8.0	21	26	12	-	EX1530.09.080	50
Pg 11	4.0	5.5	24	28	12	-	EX1530.11.055	50
Pg 11	5.5	8.5	24	28	12	-	EX1530.11.085	50
Pg 13	6.0	8.0	27	28	13	-	EX1530.13.080	50
Pg 13	8.0	11.0	27	28	13	-	EX1530.13.110	50
Pg 16	6.0	8.0	27	28	13	-	EX1530.16.080	50
Pg 16	8.0	11.0	27	28	13	-	EX1530.16.110	50
Pg 21	9.5	12.5	34	33	13	-	EX1530.21.125	25
Pg 21	12.5	16.0	34	33	13	-	EX1530.21.160	25
Pg 21	16.0	19.0	34	33	13	-	EX1530.21.190	25
Pg 21	19.0	20.5	34	33	13	-	EX1530.21.205	25
Pg 29	19.5	21.0	41	36	13	3	EX1530.29.210	25
Pg 29	21.0	23.0	41	36	13	-	EX1530.29.230	25
Pg 29	23.0	25.0	41	36	13	3	EX1530.29.250	25
Pg 29	25.0	27.5	41	36	13	-	EX1530.29.275	25
Pg 36	27.0	28.5	55	42	16	3	EX1530.36.285	10
Pg 36	28.5	30.5	55	42	16	-	EX1530.36.305	10
Pg 36	30.5	32.5	55	42	16	3	EX1530.36.325	10
Pg 36	32.5	35.0	55	42	16	-	EX1530.36.350	10
Pg 42	33.0	35.0	60	42	16	3	EX1530.42.350	10
Pg 42	35.0	37.0	60	42	16	-	EX1530.42.370	10
Pg 42	37.0	39.0	60	42	16	3	EX1530.42.390	10
Pg 42	39.0	42.0	60	42	16	-	EX1530.42.420	10
Pg 48	41.0	43.0	70	46	16	-	EX1530.48.430	5
Pg 48	43.0	45.0	70	46	16	3	EX1530.48.450	5
Pg 48	45.0	47.0	70	46	16	3	EX1530.48.470	5
Pg 48	47.0	49.0	70	46	16	-	EX1530.48.490	5

3 = Material Dichteinsatz NBR  
Auf Anfrage lieferbar:  
Für mehrere Kabel

3 = Material sealing insert NBR  
Available on request:  
For installation of multiple cables



Progress GFK EX



# Reduktionen Messing erhöhte Sicherheit Ex e II

## Reduction fittings nickel-plated brass increased safety Ex e II

### Zubehör | Accessories

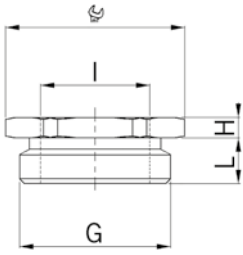

Material: Messing vernickelt  
 O-Ring: FPM  
 Schutzart: IP 66 / IP 68  
 Prüfnorm: IEC EN 60079-0 / IEC EN 60079-7 / IEC EN 60079-31  
 Gas: II 2G Ex eb IIC Gb  
 Staub: II 2D Ex tb IIIC Db  
 Zone: Gas 1 und 2 / Staub 21 und 22  
 Zertifikat: SEV 15 ATEX 0151  
 IECEx Zertifikat: IECEx SEV 15.0018  
 CCC Zertifikat: CCC 2022322313004717  
 Einsatztemperatur: -60 °C / +100 °C

Material: Nickel-plated brass  
 O-ring: FPM  
 Protection class: IP 66 / IP 68  
 Test standard: IEC EN 60079-0 / IEC EN 60079-7 / IEC EN 60079-31  
 Gas: II 2G Ex eb IIC Gb  
 Dust: II 2D Ex tb IIIC Db  
 Zone: Gas 1 and 2 / dust 21 and 22  
 Certificate: SEV 15 ATEX 0151  
 IECEx Certificate: IECEx SEV 15.0018  
 CCC Certificate: CCC 2022322313004717  
 Operation temperature: -60 °C / +100 °C



Reduktion MS EX



Aussengewinde metrisch  
 Innengewinde metrisch  
 Mit O-Ring

Outer thread metric  
 Inner thread metric  
 with O-ring

G	I	i info	 mm	H mm	L mm	i info	Art.-No.	
M10x1.5	M 8x1.25	1	13	8.0	5	2	EX3500.10.08	50
M12x1.5	M 8x1.25	1	15	3.0	5	2	EX3500.12.08	50
M12x1.5	M10x1.5	1	15	8.0	5	2	EX3500.12.10	50
M16x1.5	M10x1.5	1	18	3.0	5	-	EX3500.17.10	50
M16x1.5	M12x1.5	-	18	3.0	5	-	EX3500.17.12	50
M20x1.5	M12x1.5	-	24	3.0	6	-	EX3500.20.12	50
M20x1.5	M16x1.5	-	24	3.0	6	-	EX3500.20.17	50
M25x1.5	M16x1.5	-	30	3.5	7	-	EX3500.25.17	25
M25x1.5	M20x1.5	-	30	3.5	7	-	EX3500.25.20	25
M32x1.5	M20x1.5	-	36	4.0	8	-	EX3500.32.20	20
M32x1.5	M25x1.5	-	36	4.0	8	-	EX3500.32.25	20
M40x1.5	M25x1.5	-	46	4.5	8	-	EX3500.40.25	10
M40x1.5	M32x1.5	-	46	4.5	8	-	EX3500.40.32	10
M50x1.5	M32x1.5	-	55	5.0	9	-	EX3500.50.32	10
M50x1.5	M40x1.5	-	55	5.0	9	-	EX3500.50.40	10
M63x1.5	M40x1.5	-	70	5.5	10	-	EX3500.63.40	5
M63x1.5	M50x1.5	-	70	5.5	10	-	EX3500.63.50	5

1 = Metrisches Regelgewinde (mit VDE Testreport)

1 = Metric coarse-pitch thread (with VDE test report)

2 = Zertifikat SEV 15 ATEX 0152X / IECEx SEV 15.0019X

2 = Certificate SEV 15 ATEX 0152X / IECEx SEV 15.0019X

Das Ineinanderschrauben mehrerer Reduktionen/  
 Erweiterungen ist nach Norm nicht zulässig!

The norm interdicts to screw several reduction/  
 enlarging fittings into each other!

# Reduktionen Messing erhöhte Sicherheit Ex e II

## Reduction fittings nickel-plated brass increased safety Ex e II

### Zubehör | Accessories

Material: Messing vernickelt  
 O-Ring: FPM  
 Schutzart: IP 66 / IP 68  
 Prüfnorm: IEC EN 60079-0 / IEC EN 60079-7 / IEC EN 60079-31  
 Gas: II 2G Ex eb IIC Gb  
 Staub: II 2D Ex tb IIIC Db  
 Zone: Gas 1 und 2 / Staub 21 und 22  
 Zertifikat: SEV 15 ATEX 0151  
 IECEx Zertifikat: IECEx SEV 15.0018  
 CCC Zertifikat: CCC 2022322313004717  
 Einsatztemperatur: -60 °C / +100 °C

Material: Nickel-plated brass  
 O-ring: FPM  
 Protection class: IP 66 / IP 68  
 Test standard: IEC EN 60079-0 / IEC EN 60079-7 / IEC EN 60079-31  
 Gas: II 2G Ex eb IIC Gb  
 Dust: II 2D Ex tb IIIC Db  
 Zone: Gas 1 and 2 / dust 21 and 22  
 Certificate: SEV 15 ATEX 0151  
 IECEx Certificate: IECEx SEV 15.0018  
 CCC Certificate: CCC 2022322313004717  
 Operation temperature: -60 °C / +100 °C

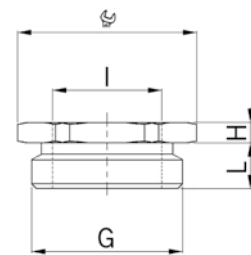

Aussengewinde Pg  
 Innengewinde metrisch  
 Mit O-Ring

Outer thread Pg  
 Inner thread metric  
 with O-ring

G	I	i info	 mm	H mm	L mm	i info	Art.-No.	
Pg 7	M 8x1.25	1	15	3.0	6	2	EX3500.07.08	50
Pg 7	M 10x1.5	1	15	7.0	6	2	EX3500.07.10	50
Pg 9	M 8x1.25	1	18	3.0	6	-	EX3500.09.08	50
Pg 9	M 10x1.5	1	18	3.0	6	-	EX3500.09.10	50
Pg 9	M 12x1.5	-	18	8.0	6	-	EX3500.09.12	50
Pg 11	M 8x1.25	1	21	3.0	6	-	EX3500.11.08	50
Pg 11	M 10x1.5	1	21	3.0	6	-	EX3500.11.10	50
Pg 11	M 12x1.5	-	21	3.0	6	-	EX3500.11.12	50
Pg 11	M 16x1.5	-	21	8.0	6	-	EX3500.11.17	50
Pg 13	M 12x1.5	-	24	3.0	6	-	EX3500.13.12	50
Pg 13	M 16x1.5	-	24	3.0	6	-	EX3500.13.17	50
Pg 16	M 12x1.5	-	24	3.0	6	-	EX3500.16.12	25
Pg 16	M 16x1.5	-	24	3.0	6	-	EX3500.16.17	25
Pg 16	M 20x1.5	-	24	10.5	6	-	EX3500.16.20	25
Pg 21	M 16x1.5	-	30	3.5	7.5	-	EX3500.21.17	25
Pg 21	M 20x1.5	-	30	3.5	7.5	-	EX3500.21.20	25
Pg 21	M 25x1.5	-	30	10.5	7.5	-	EX3500.21.25	25
Pg 29	M 25x1.5	-	38	4.0	8	-	EX3500.29.25	20
Pg 29	M 32x1.5	-	38	13.0	8	-	EX3500.29.32	20
Pg 36	M 32x1.5	-	50	4.5	8	-	EX3500.36.32	10
Pg 36	M 40x1.5	-	50	4.5	8	-	EX3500.36.40	10
Pg 42	M 32x1.5	-	55	5.0	10	-	EX3500.42.32	10
Pg 42	M 40x1.5	-	55	5.0	10	-	EX3500.42.40	10
Pg 42	M 50x1.5	-	55	15.0	10	-	EX3500.42.50	10
Pg 48	M 40x1.5	-	65	5.5	11	-	EX3500.48.40	5
Pg 48	M 50x1.5	-	65	5.5	11	-	EX3500.48.50	5

1 = Metrisches Regelgewinde (mit VDE Testreport)

1 = Metric coarse-pitch thread (with VDE test report)

2 = Zertifikat SEV 15 ATEX 0152X / IECEx SEV 15.0019X

2 = Certificate SEV 15 ATEX 0152X / IECEx SEV 15.0019X

Das Ineinanderschrauben mehrerer Reduktionen/  
 Erweiterungen ist nach Norm nicht zulässig!

The norm interdicts to screw several reduction/  
 enlarging fittings into each other!



Reduktion MS EX



# Erweiterungen Messing erhöhte Sicherheit Ex e II

## Enlarging fittings nickel-plated brass increased safety Ex e II

### Zubehör | Accessories

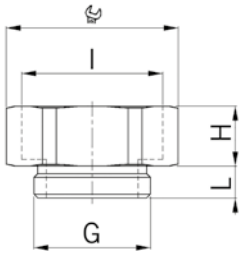

Material: Messing vernickelt  
 O-Ring: FPM  
 Schutzart: IP 66 / IP 68  
 Prüfnorm: IEC EN 60079-0 / IEC EN 60079-7 / IEC EN 60079-31  
 Gas: II 2G Ex eb IIC Gb  
 Staub: II 2D Ex tb IIIC Db  
 Zone: Gas 1 und 2 / Staub 21 und 22  
 Zertifikat: SEV 15 ATEX 0151  
 IECEx Zertifikat: IECEx SEV 15.0018  
 CCC Zertifikat: CCC 2022322313004717  
 Einsatztemperatur: -60 °C / +100 °C

Material: Nickel-plated brass  
 O-ring: FPM  
 Protection class: IP 66 / IP 68  
 Test standard: IEC EN 60079-0 / IEC EN 60079-7 / IEC EN 60079-31  
 Gas: II 2G Ex eb IIC Gb  
 Dust: II 2D Ex tb IIIC Db  
 Zone: Gas 1 and 2 / dust 21 and 22  
 Certificate: SEV 15 ATEX 0151  
 IECEx Certificate: IECEx SEV 15.0018  
 CCC Certificate: CCC 2022322313004717  
 Operation temperature: -60 °C / +100 °C



Erweiterung MS EX



Aussengewinde metrisch  
 Innengewinde metrisch  
 Mit O-Ring

Outer thread metric  
 Inner thread metric  
 with O-ring

G	I	i info	 mm	H mm	L mm	i info	Art.-No.	
<b>M 8x1.25</b>	M10x1.5	1	13	9	5	2	<b>EX3600.08.10</b>	50
<b>M10x1.5</b>	M12x1.5	1	15	9	5	2	<b>EX3600.10.12</b>	50
<b>M12x1.5</b>	M16x1.5	-	18	9	5	2	<b>EX3600.12.17</b>	50
<b>M16x1.5</b>	M20x1.5	-	24	10	5	-	<b>EX3600.17.20</b>	50
<b>M20x1.5</b>	M25x1.5	-	30	11.5	6	-	<b>EX3600.20.25</b>	25
<b>M25x1.5</b>	M32x1.5	-	36	14	7	-	<b>EX3600.25.32</b>	25
<b>M32x1.5</b>	M40x1.5	-	46	14	8	-	<b>EX3600.32.40</b>	25
<b>M40x1.5</b>	M50x1.5	-	55	16	8	-	<b>EX3600.40.50</b>	10
<b>M50x1.5</b>	M63x1.5	-	70	17	9	-	<b>EX3600.50.63</b>	10

1 = Metrisches Regelgewinde (mit VDE Testreport)

1 = Metric coarse-pitch thread (with VDE test report)

2 = Zertifikat SEV 15 ATEX 0152X / IECEx SEV 15.0019X

2 = Certificate SEV 15 ATEX 0152X / IECEx SEV 15.0019X

Das Ineinanderschrauben mehrerer Reduktionen/  
 Erweiterungen ist nach Norm nicht zulässig!

The norm interdicts to screw several reduction/  
 enlarging fittings into each other!

# Erweiterungen Messing erhöhte Sicherheit Ex e II

## Enlarging fittings nickel-plated brass increased safety Ex e II

### Zubehör | Accessories

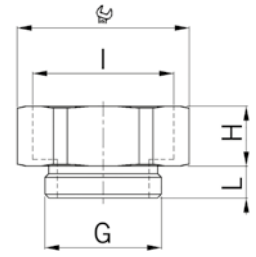

Material: Messing vernickelt  
 O-Ring: FPM  
 Schutzart: IP 66 / IP 68  
 Prüfnorm: IEC EN 60079-0 /  
 IEC EN 60079-7 /  
 IEC EN 60079-31  
 Gas: II 2G Ex eb IIC Gb  
 Staub: II 2D Ex tb IIIC Db  
 Zone: Gas 1 und 2 /  
 Staub 21 und 22  
 Zertifikat: SEV 15 ATEX 0151  
 IECEx Zertifikat: IECEx SEV 15.0018  
 CCC Zertifikat: CCC 2022322313004717  
 Einsatztemperatur: -60 °C / +100 °C

Material: Nickel-plated brass  
 O-ring: FPM  
 Protection class: IP 66 / IP 68  
 Test standard: IEC EN 60079-0 /  
 IEC EN 60079-7 /  
 IEC EN 60079-31  
 Gas: II 2G Ex eb IIC Gb  
 Dust: II 2D Ex tb IIIC Db  
 Zone: Gas 1 and 2 /  
 dust 21 and 22  
 Certificate: SEV 15 ATEX 0151  
 IECEx Certificate: IECEx SEV 15.0018  
 CCC Certificate: CCC 2022322313004717  
 Operation temperature: -60 °C / +100 °C



Aussengewinde Pg  
 Innengewinde metrisch  
 Mit O-Ring

Outer thread Pg  
 Inner thread metric  
 with O-ring

G	I	 mm	H mm	L mm	i info	Art.-No.	
Pg 7	M12x1.5	15	9.0	6	2	EX3600.07.12	50
Pg 7	M16x1.5	18	9.0	6	2	EX3600.07.17	50
Pg 9	M16x1.5	18	9.5	6	-	EX3600.09.17	50
Pg 9	M20x1.5	24	10.5	6	-	EX3600.09.20	50
Pg 11	M20x1.5	24	10.5	6	-	EX3600.11.20	50
Pg 11	M25x1.5	30	11.5	6	-	EX3600.11.25	25
Pg 13	M20x1.5	24	10.5	6	-	EX3600.13.20	50
Pg 13	M25x1.5	30	11.5	6	-	EX3600.13.25	25
Pg 16	M25x1.5	30	11.5	6	-	EX3600.16.25	25
Pg 16	M32x1.5	36	13.5	6	-	EX3600.16.32	25
Pg 21	M32x1.5	36	14.0	7.5	-	EX3600.21.32	25
Pg 21	M40x1.5	46	14.0	7.5	-	EX3600.21.40	20
Pg 29	M40x1.5	46	14.0	8	-	EX3600.29.40	20
Pg 29	M50x1.5	55	16.0	8	-	EX3600.29.50	10
Pg 36	M50x1.5	55	16.0	8	-	EX3600.36.50	10
Pg 36	M63x1.5	70	17.0	8	-	EX3600.36.63	10
Pg 42	M63x1.5	70	17.0	10	-	EX3600.42.63	10
Pg 48	M63x1.5	70	17.0	11	-	EX3600.48.63	10



Erweiterung MS EX



2 = Zertifikat SEV 15 ATEX 0152X / IECEx SEV 15.0019X      2 = Certificate SEV 15 ATEX 0152X / IECEx SEV 15.0019X  
 Das Ineinanderschrauben mehrerer Reduktionen/  
 Erweiterungen ist nach Norm nicht zulässig!  
 The norm interdicts to screw several reduction/  
 enlarging fittings into each other!

# Verschlusschrauben Messing erhöhte Sicherheit Ex e II

## Locking plugs nickel-plated brass increased safety Ex e II

### Kurzes Anschlussgewinde metrisch | Short entry thread metric

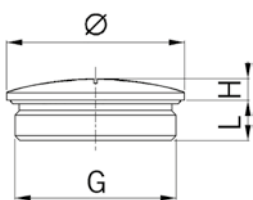

Material: Messing vernickelt  
 O-Ring: FPM  
 Schutzart: IP 66 / IP 68  
 Prüfnorm: IEC EN 60079-0 / IEC EN 60079-7 / IEC EN 60079-31  
 Gas: II 2G Ex eb IIC Gb  
 Staub: II 2D Ex tb IIIC Db  
 Zone: Gas 1 und 2 / Staub 21 und 22  
 Zertifikat: SEV 15 ATEX 0151  
 IECEx Zertifikat: IECEx SEV 15.0018  
 CCC Zertifikat: CCC 2022322313004717  
 Einsatztemperatur: -60 °C / +100 °C

Material: Nickel-plated brass  
 O-ring: FPM  
 Protection class: IP 66 / IP 68  
 Test standard: IEC EN 60079-0 / IEC EN 60079-7 / IEC EN 60079-31  
 Gas: II 2G Ex eb IIC Gb  
 Dust: II 2D Ex tb IIIC Db  
 Zone: Gas 1 and 2 / dust 21 and 22  
 Certificate: SEV 15 ATEX 0151  
 IECEx Certificate: IECEx SEV 15.0018  
 CCC Certificate: CCC 2022322313004717  
 Operation temperature: -60 °C / +100 °C



Verschlusszapfen  
MS EX



Mit O-Ring

with O-ring

G	Ø mm	H mm	L mm	i info	Art.-No.	
M8x1.25	10	3	5	1	EX8708.08	50
M10x1.5	12	3	5	1	EX8710.08	50
M12x1.5	14	3	5	-	EX8712.08	50
M16x1.5	19	3	5	-	EX8717.08	50
M20x1.5	24	3	6	-	EX8720.08	25
M25x1.5	28	4	7	-	EX8725.08	25
M32x1.5	35	4	8	-	EX8732.08	10
M40x1.5	45	6	8	-	EX8740.08	10
M50x1.5	55	6	9	-	EX8750.08	10
M63x1.5	70	6	10	-	EX8763.08	10

1 = Metrisches Regelgewinde (mit VDE Testreport)

1 = Metric coarse-pitch thread (with VDE test report)

Auf Anfrage lieferbar:

Available on request:

Langes Anschlussgewinde

Long entry thread

Ausführungen in Stahl A2 und A4

Executions in steel A2 and A4

### Kurzes Anschlussgewinde Pg | Short entry thread Pg



Verschlusszapfen  
MS EX



Mit O-Ring

with O-ring

G	Ø mm	H mm	L mm	Art.-No.	
Pg 7	14	3	5	EX8707.08	50
Pg 9	17	3	6	EX8709.08	50
Pg 11	20	3	6	EX8711.08	50
Pg 13	22	3	6.5	EX8713.08	50
Pg 16	24	3	6.5	EX8716.08	50
Pg 21	30	4	7	EX8721.08	10
Pg 29	39	4	8	EX8729.08	10
Pg 36	50	6	9	EX8736.08	10
Pg 48	65	6	10	EX8748.08	10

Auf Anfrage lieferbar:

Available on request:

Langes Anschlussgewinde

Long entry thread

Ausführungen in Stahl A2 und A4

Executions in steel A2 and A4

# Verschlusschrauben Kunststoff erhöhte Sicherheit Ex e II

## Synthetic locking plugs for increased safety Ex e II

### Anschlussgewinde metrisch | Entry thread metric

Material: Polyamid  
glasfaserverstärkt

O-Ring: NBR

Schutzart: IP 68 (bis 10 bar) / IP 69

Prüfnorm: IEC EN 60079-0 /  
IEC EN 60079-7 /  
IEC EN 60079-31

Gas: II 2G Ex e IIC Gb

Staub: II 1D Ex ta IIIC Ga

Zone: Gas 2 / Staub 21

Zertifikat: DMT 03 ATEX E 049

IECEX Zertifikat: IECEX BVS 07.0021

Einsatztemperatur: -20 °C / +90 °C

Material: Polyamide  
glass fiber reinforced

O-ring: NBR

Protection class: IP 68 (up to 10 bar) / IP 69

Test standard: IEC EN 60079-0 /  
IEC EN 60079-7 /  
IEC EN 60079-31

Gas: II 2G Ex e IIC Gb

Dust: II 1D Ex ta IIIC Ga

Zone: Gas 2 / dust 21

Certificate: DMT 03 ATEX E 049

IECEX Certificate: IECEX BVS 07.0021

Operation temperature: -20 °C / +90 °C

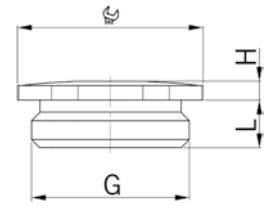

Schwarz RAL 9005  
Mit O-Ring

Black RAL 9005  
with O-ring

G		H	L	Art.-No.		
mm	mm	mm	mm			
M12x1.5	15	6	4.5	8.5	8841.12	100
M16x1.5	19	8	4.5	8.5	8841.17	100
M20x1.5	24	8	5.5	9.0	8841.20	100
M25x1.5	28	8	5.5	10.5	8841.25	100
M32x1.5	36	8	6.0	11.5	8841.32	100
M40x1.5	46	8	6.5	11.5	8841.40	50
M50x1.5	55	8	6.5	13.5	8841.50	25
M63x1.5	70	8	6.5	14.5	8841.63	10



### Anschlussgewinde Pg | Entry thread Pg

Schwarz RAL 9005  
Mit O-Ring

Black RAL 9005  
with O-ring

G		H	L	Art.-No.		
mm	mm	mm	mm			
Pg 7	15	6	13.0	8.5	8841.07	100
Pg 9	19	8	13.0	8.5	8841.09	100
Pg 11	24	8	14.5	9.0	8841.11	100
Pg 13	24	8	14.5	9.0	8841.13	100
Pg 16	28	8	16.0	10.5	8841.16	100
Pg 21	36	8	17.5	11.5	8841.21	100
Pg 29	46	8	18.0	11.5	8841.29	50
Pg 36	55	8	20.0	13.5	8841.36	25
Pg 42	60	8	20.0	13.5	8841.42	10
Pg 48	70	8	21.0	14.5	8841.48	10



# Kabelverschraubungen Progress® AgreenO Messing bleifrei Progress® AgreenO cable glands of lead-free brass



Die **Progress® AgreenO** Produkte von AGRO verwenden ein Material mit der Werkstoffbezeichnung CuZn21Si3P mit einem maximalen Bleigehalt von 0,1%. Nachhaltigkeit und Qualität ist ein wichtiger Baustein für die Zukunft. Anwender dieser nachhaltigen und zukunftsorientierten Produktalternative müssen dabei keinerlei Abstriche in Bezug auf Performance, Qualität oder Festigkeit hinnehmen. Das gilt sowohl für alle mechanischen Eigenschaften und die Korrosionsbeständigkeit als auch für die EMV-Eigenschaften.

Der Wahl von CuZn21Si3P bleifrei als Material für das **Progress® AgreenO** Sortiment ging ein strenges mehrmonatiges Evaluationsverfahren voraus. Die Wahl des Materials wurde durch zahlreiche Tests im AGRO-Prüflabor bestätigt. Selbstverständlich erfüllen auch diese Produkte die IEC EN 62444 und UL 514B sowie die Schutzarten IP 68 / IP 69.

AGRO's **Progress® AgreenO** products use the material CuZn21Si3P with a maximum lead content of 0.1%. Sustainability and quality are together an important foundation element for the future. Of course, users of these sustainable and future-oriented products do not have to accept any compromises in terms of performance, quality or reliability. This applies not only in relation to all mechanical properties and corrosion resistance, but also to the products' EMC properties.





The choice of lead-free CuZn21Si3P as material for the **Progress® AgreenO** range was preceded by a rigorous evaluation process that lasted several months. The suitability of the material was confirmed by numerous tests in the AGRO testing laboratory. Of course, these products also comply with IEC EN 62444 and UL 514B, and meet the demands of protection classes IP 68 / IP 69.



Die Artikelnummern für die bleifreien Kabelverschraubungen **Progress® AgreenO** werden mit dem Zusatz „LF“ (Lead Free) ergänzt. Das Produkt selbst ist mit einer Kerbe an der Druckmutter und dem Unterteil gekennzeichnet. Dadurch ist die sichere Identifizierung jederzeit sichergestellt.

The part numbers of lead-free **Progress® AgreenO** cable glands include the letters "LF" at the end of the part number. The product itself is marked with a groove on the compression nut as well as on the lower part, ensuring reliable identification at all times.



Kabelverschraubungen Progress® AgreenO Messing bleifrei Cable glands Progress® AgreenO nickel-plated brass lead-free	 <b>200 - 201</b>	1
Kabelverschraubungen Progress® AgreenO EMV easyCONNECT Messing bleifrei mit Kontaktfeder Cable glands Progress® AgreenO EMC easyCONNECT nickel-plated brass lead-free with contact spring	 <b>202</b>	2
Kabelverschraubungen Progress® AgreenO EMV Messing bleifrei mit Kontakthülse Cable glands Progress® AgreenO EMC nickel-plated brass lead-free with contact sleeve	 <b>203 - 204</b>	3
EMV-Gegenmuttern AgreenO Messing bleifrei mit Schneidezähnen Lock nuts AgreenO nickel-plated brass lead-free with cutting teeth	 <b>205</b>	4

1

2

3

4

5

6

7

8

9

10

11

12

13

14

15

# Kabelverschraubungen Progress® AgreenO Messing bleifrei

## Progress® AgreenO cable glands of lead-free brass

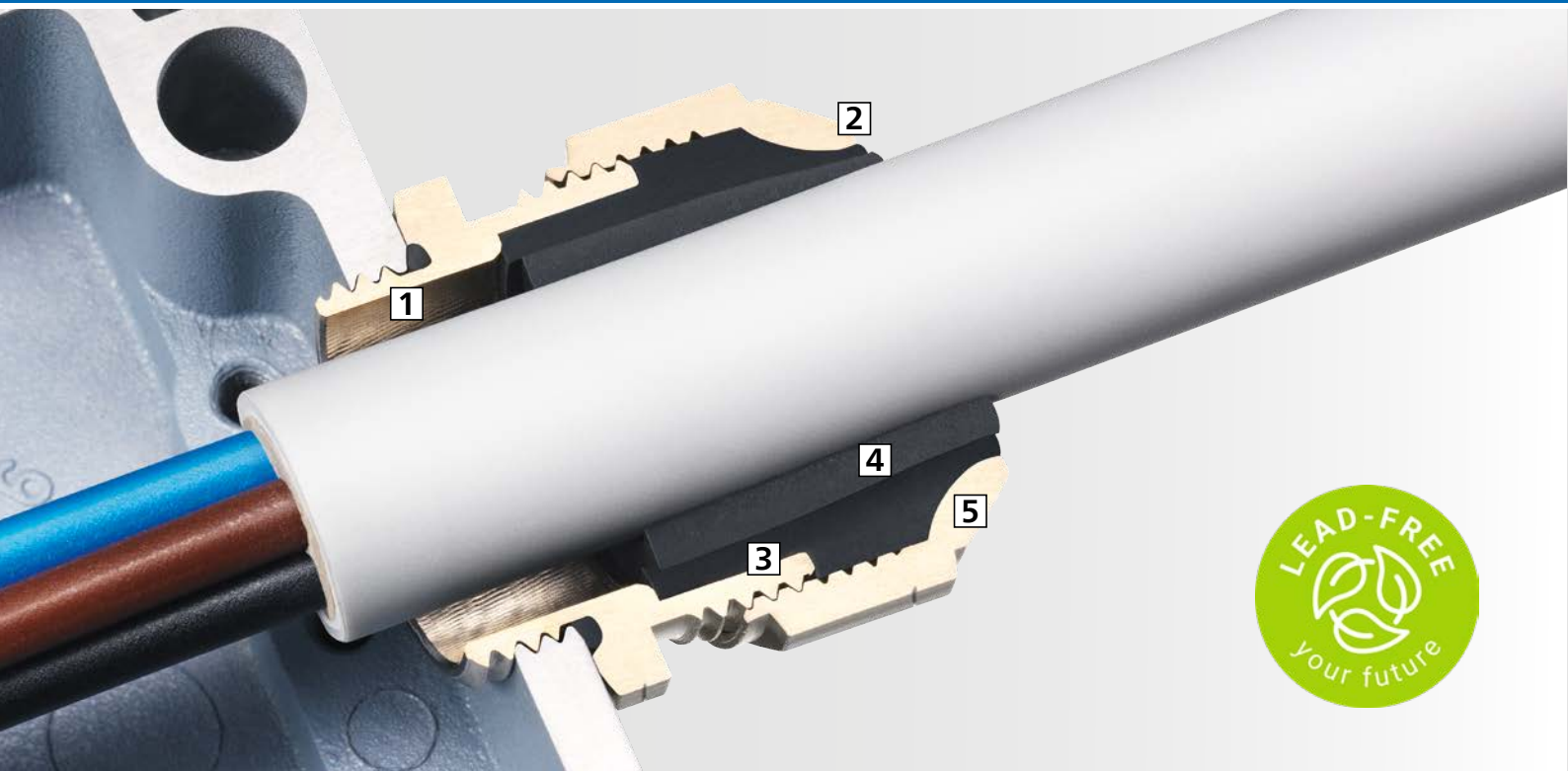

**AGRO Kabelverschraubungen Progress® AgreenO Messing bleifrei** sind bewährte Helfer für die fachgerechte Kabeleinführung in Industrieanlagen. Durch die richtige Wahl mit dem passenden Dichteinsatz sind sie überall einsetzbar. Die herausragende Kompressionstechnik sorgt für eine hohe Dichtigkeit und eine äusserst kabelschonende Zugentlastung auch bei dynamischen Belastungen.

### 1 Kurze, lange oder Spezial-Anschlussgewinde

Kabelverschraubungen **Progress® AgreenO** mit kurzem oder langem Anschlussgewinde in metrischer Ausführung, Ausführungen mit Pg- oder NPT-Anschlussgewinde sind auf Anfrage lieferbar. Die Anschlussgewinde können direkt ins Gehäuse geschraubt werden oder können bei vorhandenen Bohrungen mit Gegenmutter verwendet werden.

### 2 Sichtbare Sicherheit

Der kleine Wulst des Dichteinsatzes bestätigt das richtige Anzugsdrehmoment oder verwenden Sie für das richtige Drehmoment unsere Montagedrehmoment-Tabelle im Internet unter [www.agro.ch](http://www.agro.ch).

### 3 Hoher Verdrehschutz

Die im Unterteil integrierte Längsrandrierung sorgt über den Dichteinsatz für eine hohe Verdrehsicherheit und verhindert so das Mitdrehen des Kabels.

### 4 Grosse Flexibilität

Zweiteilige Dichteinsätze können in Sekundenschnelle vor Ort auf den vorhandenen Kabeldurchmesser angepasst werden.

### 5 Garantierte Dichtigkeit

Auf den Dichteinsatz abgestimmte Innenkonturen sorgen für eine zielgerichtete Verformung des Dichteinsatzes und garantieren somit dessen perfekte Abdichtung. Die Schutzart IP 68 bis 10 bar sowie IP 69 ermöglichen eine breite Anwendung.

**AGRO Progress® AgreenO cable glands of lead-free brass** are tried-and-trusted cable entry solutions for professional cabling work in industrial facilities. With the right selection and the right sealing insert, they can be used anywhere. The cable gland's outstanding compression technology ensures a high degree of leak-tightness and extremely cable-friendly strain relief, even if subjected to dynamic loading.

### 1 Short, Long or Special entry threads

**Progress® AgreenO** cable glands with short or long connection threads in metric design as standard; versions with PG or NPT entry threads are available on request. The entry thread can be screwed directly into the housing, or the cable gland can alternatively be installed with a lock nut where a suitable hole exists.

### 2 Visible reliability

A slight bulging of the sealing insert indicates the correct tightening torque during installation, or refer to the appropriate torque table on our website, [www.agro.ch](http://www.agro.ch).

### 3 Good anti-rotation protection

The longitudinal knurling (surface texture) applied to the cable gland's lower part provides a high degree of protection against cable rotation, via the sealing insert.

### 4 Great flexibility

Two-part sealing inserts can be adapted on site in a matter of seconds to suit the existing cable diameter.

### 5 Reliable leak-tightness

Inner contours that precisely suit the shape of the sealing insert ensure optimal deformation of the sealing insert and thus perfect sealing. Protection classes IP 68 (up to 10 bar) and IP 69 facilitate a wide range of applications.

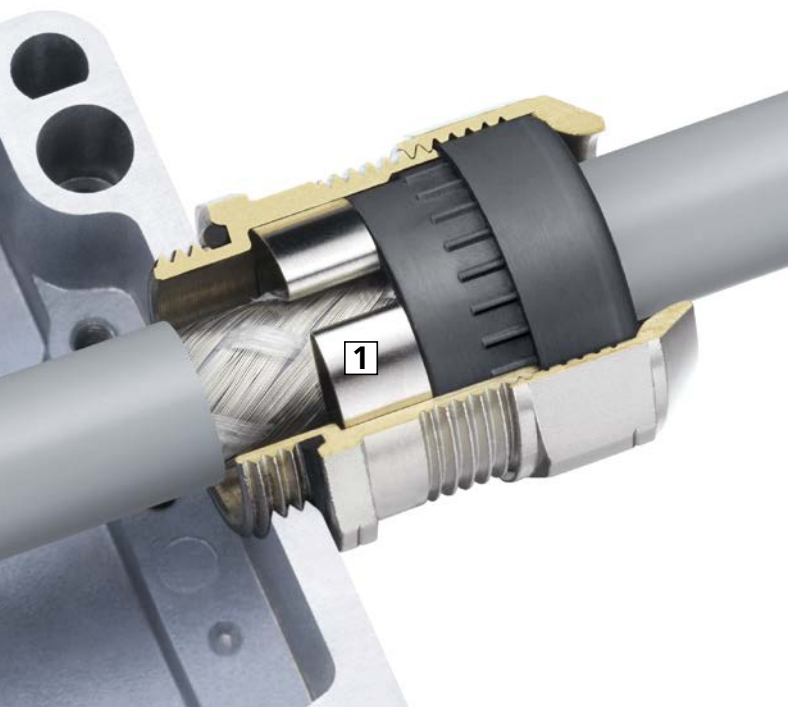

### Progress® AgreenO EMV easyCONNECT Messing bleifrei

Die Kabelverschraubung gewährleistet volle Installationskontrolle und gleicht Toleranzen in den Schirmdicken für einen sicheren Schirmabgriff aus. Das Federsystem ermöglicht eine gute und sichere Schirmkontaktierung sowohl bei partiell abisolierten Abschirmkabeln als auch bei vollständig freigelegten Kabelschirmen.

#### 1 Optimale Schirmkontaktierung

Die kraftvolle, schonende Klemmung des Kabelschirms garantiert einen hervorragenden Schirmkontakt und sorgt für extrem niedrige Transferimpedanzen. Durch die spezielle Formgebung der Kontaktfeder ist nicht nur ein grosser Schirmklemmbereich sondern auch die Demontierbarkeit der Kabelverschraubung ohne Zerstörung des EMV-Geflechtes gegeben.

### Progress® AgreenO EMC easyCONNECT of lead-free brass

This cable gland provides full installation control and compensates for tolerances in shielding thickness to ensure reliable shield grip. The spring system facilitates good and reliable shield contact for either partially stripped shielded cables or fully exposed cable shields.

#### 1 Optimal shield contact

The strong yet gentle clamping of the cable shield ensures excellent shield contact and extremely low transfer impedances. The special shape of the contact spring results in a wide shield clamping range, and also enables the cable gland to be dismantled without destroying the EMC braiding.

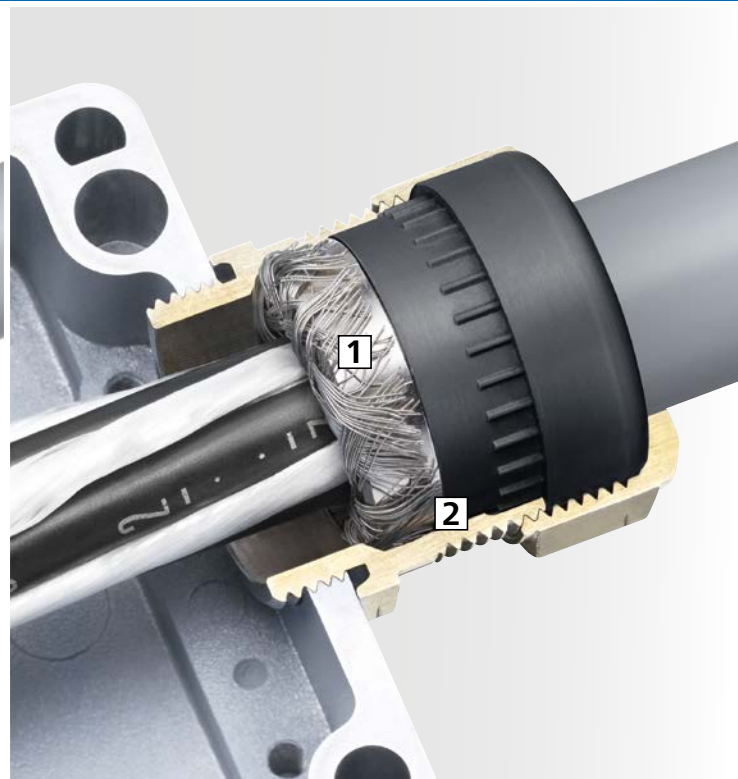

### Progress® AgreenO EMV Messing bleifrei

Die Kabelverschraubungen mit der bewährten Kontakthülse ermöglichen eine Schirmkontaktierung von 360° bei in der Kabelverschraubung endendem Schirmgeflecht. Die massgebende Kantengeometrie der Kontakthülse verhindert hierbei ein Abscheren des Schirmgeflechtes.

#### 1 Kleinste Übergangswiderstände

Der konzentrische Schirmabgriff von 360° bürgt für kleinste Übergangswiderstände.

#### 2 Permanenter Kontaktdruck

Die ineinandergreifende Kombination „Dichteinsatz-Kontakthülse“ garantiert einen permanenten Kontaktdruck des Schirmgeflechtes am Unterteil.

### Progress® AgreenO EMC of lead-free brass

This cable gland with its tried-and-tested contact sleeve facilitates 360° shield contact with the shield braiding ending in the cable gland. The geometry of the contact sleeve's edge prevents the shield braiding from shearing off.

#### 1 Very low contact resistance

The concentric 360° shield grip minimises contact resistance.

#### 2 Permanent contact pressure

The interlocking combination “sealing insert – contact sleeve” ensures permanent contact pressure of the shield braiding on the cable gland's lower part.

# Kabelverschraubungen Progress® AgreenO Messing bleifrei

## Cable glands Progress® AgreenO nickel-plated brass lead-free

### Kurzes Anschlussgewinde metrisch | Short entry thread metric

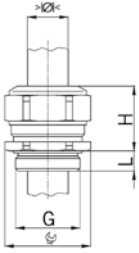

Material: Messing CuZn21Si3P bleifrei  
 Oberfläche: Vernickelt  
 Kennzeichnung: 1 Rille  
 Dichtung: TPE  
 O-Ring: NBR  
 Zugentlastung: Ausführung A nach EN 62444  
 Schutzart: IP 68 (bis 10 bar) / IP 69  
 Einsatztemperatur: -40 °C / +100 °C

Material: Brass CuZn21Si3P lead-free  
 Surface: Nickel-plated  
 Identification: 1 groove  
 Seal: TPE  
 O-ring: NBR  
 Strain relief: Version A acc. to EN 62444  
 Protection class: IP 68 (up to 10 bar) / IP 69  
 Operation temperature: -40 °C / +100 °C



Einteiliger Dichteinsatz  
 Nicht durchgehend isolierend

One-piece sealing insert  
 not overall length insulated

G	>Ø< min mm	>Ø< max mm	Ø mm	H mm	L mm	Art.-No.	
M12x1.5	3.5	5.0	15	17	5	1000.12.050LF	50
M12x1.5	5.0	6.5	15	17	5	1000.12.065LF	50
M12x1.5	6.5	8.0	15	17	5	1000.12.080LF	50
M16x1.5	3.5	4.5	18	20	5	1000.17.045LF	50
M16x1.5	4.5	6.0	18	20	5	1000.17.060LF	50
M16x1.5	6.0	8.0	18	20	5	1000.17.080LF	50
M16x1.5	8.0	10.5	18	22	5	1000.17.105LF	50
M20x1.5	6.0	8.0	24	21	6	1000.20.080LF	50
M20x1.5	8.0	11.0	24	21	6	1000.20.110LF	50
M20x1.5	11.0	15.0	24	23	6	1000.20.150LF	50
M25x1.5	9.5	12.5	30	25	7	1000.25.125LF	25
M25x1.5	12.5	16.0	30	27	7	1000.25.160LF	25
M25x1.5	16.0	20.5	30	28	7	1000.25.205LF	25
M32x1.5	14.0	17.0	36	28	8	1000.32.170LF	25
M32x1.5	17.0	21.0	36	28	8	1000.32.210LF	25
M32x1.5	21.0	25.5	36	28	8	1000.32.255LF	25
M40x1.5	20.0	24.0	46	31	8	1000.40.240LF	10
M40x1.5	24.0	28.5	46	31	8	1000.40.285LF	10
M40x1.5	28.5	33.0	46	31	8	1000.40.330LF	10
M50x1.5	29.0	33.0	55	34	9	1000.50.330LF	10
M50x1.5	33.0	37.0	55	34	9	1000.50.370LF	10
M50x1.5	37.0	42.0	55	34	9	1000.50.420LF	10
M63x1.5	35.0	40.0	70	37	10	1000.63.400LF	5
M63x1.5	40.0	46.0	70	37	10	1000.63.460LF	5
M63x1.5	46.0	52.0	70	37	10	1000.63.520LF	5

Auf Anfrage lieferbar:  
 Anschlussgewinde Pg und NPT

Available on request:  
 Entry thread Pg and NPT

Zweiteiliger Dichteinsatz  
 Nicht durchgehend isolierend

Two-piece sealing insert  
 not overall length insulated

G	>Ø< min mm	>Ø< max mm	>Ø< min mm	>Ø< max mm	Ø mm	H mm	L mm	Art.-No.	
M16x1.5	6.0	8.0	8.0	10.5	18	22	5	1000.17LF	50
M20x1.5	8.0	11.0	11.0	15.0	24	23	6	1000.20LF	50
M25x1.5	12.5	16.0	16.0	20.5	30	28	7	1000.25LF	25
M32x1.5	17.0	21.0	21.0	25.5	36	28	8	1000.32LF	25
M40x1.5	24.0	28.5	28.5	33.0	46	31	8	1000.40LF	10
M50x1.5	33.0	37.0	37.0	42.0	55	34	9	1000.50LF	10
M63x1.5	40.0	46.0	46.0	52.0	70	37	10	1000.63LF	5

Auf Anfrage lieferbar:  
 Anschlussgewinde Pg und NPT

Available on request:  
 Entry thread Pg and NPT

# Kabelverschraubungen Progress® AgreenO Messing bleifrei Cable glands Progress® AgreenO nickel-plated brass lead-free

## Langes Anschlussgewinde metrisch | Long entry thread metric

Material:	Messing CuZn21Si3P bleifrei	Material:	Brass CuZn21Si3P lead-free
Oberfläche:	Vernickelt	Surface:	Nickel-plated
Kennzeichnung:	1 Rille	Identification:	1 groove
Dichtung:	TPE	Seal:	TPE
O-Ring:	NBR	O-ring:	NBR
Zugentlastung:	Ausführung A nach EN 62444	Strain relief:	Version A acc. to EN 62444
Schutzart:	IP 68 (bis 10 bar) / IP 69	Protection class:	IP 68 (up to 10 bar) / IP 69
Einsatztemperatur:	-40 °C / +100 °C	Operation temperature:	-40 °C / +100 °C

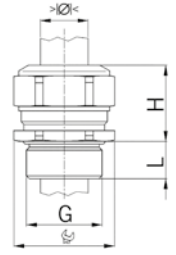

Einteiliger Dichteinsatz  
Nicht durchgehend isolierend

One-piece sealing insert  
not overall length insulated

G	$\begin{matrix} \text{>}\varnothing\text{<} \\ \text{min mm} \end{matrix}$	$\begin{matrix} \text{>}\varnothing\text{<} \\ \text{max mm} \end{matrix}$	$\begin{matrix} \text{H} \\ \text{mm} \end{matrix}$	$\begin{matrix} \text{L} \\ \text{mm} \end{matrix}$	Art.-No.	
M12x1.5	3.5	5.0	15	17	1100.12.050LF	50
M12x1.5	5.0	6.5	15	17	1100.12.065LF	50
M12x1.5	6.5	8.0	15	17	1100.12.080LF	50
M16x1.5	3.5	4.5	18	20	1100.17.045LF	50
M16x1.5	4.5	6.0	18	20	1100.17.060LF	50
M16x1.5	6.0	8.0	18	20	1100.17.080LF	50
M16x1.5	8.0	10.5	18	22	1100.17.105LF	50
M20x1.5	6.0	8.0	24	21	1100.20.080LF	50
M20x1.5	8.0	11.0	24	21	1100.20.110LF	50
M20x1.5	11.0	15.0	24	23	1100.20.150LF	50
M25x1.5	9.5	12.5	30	25	1100.25.125LF	25
M25x1.5	12.5	16.0	30	27	1100.25.160LF	25
M25x1.5	16.0	20.5	30	28	1100.25.205LF	25
M32x1.5	14.0	17.0	36	28	1100.32.170LF	25
M32x1.5	17.0	21.0	36	28	1100.32.210LF	25
M32x1.5	21.0	25.5	36	28	1100.32.255LF	25
M40x1.5	20.0	24.0	46	31	1100.40.240LF	10
M40x1.5	24.0	28.5	46	31	1100.40.285LF	10
M40x1.5	28.5	33.0	46	31	1100.40.330LF	10
M50x1.5	29.0	33.0	55	34	1100.50.330LF	10
M50x1.5	33.0	37.0	55	34	1100.50.370LF	10
M50x1.5	37.0	42.0	55	34	1100.50.420LF	10
M63x1.5	35.0	40.0	70	37	1100.63.400LF	5
M63x1.5	40.0	46.0	70	37	1100.63.460LF	5
M63x1.5	46.0	52.0	70	37	1100.63.520LF	5



Auf Anfrage lieferbar:  
Anschlussgewinde Pg und NPT

Available on request:  
Entry thread Pg and NPT

Zweiteiliger Dichteinsatz  
Nicht durchgehend isolierend

Two-piece sealing insert  
not overall length insulated

G	$\begin{matrix} \text{>}\varnothing\text{<} \\ \text{min mm} \end{matrix}$	$\begin{matrix} \text{>}\varnothing\text{<} \\ \text{max mm} \end{matrix}$	$\begin{matrix} \text{H} \\ \text{mm} \end{matrix}$	$\begin{matrix} \text{L} \\ \text{mm} \end{matrix}$	Art.-No.				
M16x1.5	6.0	8.0	8.0	10.5	18	22	10	1100.17LF	50
M20x1.5	8.0	11.0	11.0	15.0	24	23	10	1100.20LF	50
M25x1.5	12.5	16.0	16.0	20.5	30	28	11	1100.25LF	25
M32x1.5	17.0	21.0	21.0	25.5	36	28	13	1100.32LF	25
M40x1.5	24.0	28.5	28.5	33.0	46	31	13	1100.40LF	10
M50x1.5	33.0	37.0	37.0	42.0	55	34	14	1100.50LF	10
M63x1.5	40.0	46.0	46.0	52.0	70	37	14	1100.63LF	5

Auf Anfrage lieferbar:  
Anschlussgewinde Pg und NPT

Available on request:  
Entry thread Pg and NPT

**Kurzes Anschlussgewinde metrisch | Short entry thread metric**

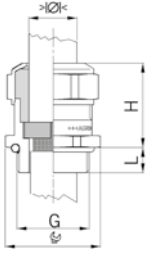

Material: Messing CuZn21Si3P bleifrei  
 Oberfläche: Vernickelt  
 Kennzeichnung: 1 Rille  
 Kontaktfeder: Federstahl 1.4310  
 Dichtung: TPE  
 O-Ring: NBR  
 Zugentlastung: Ausführung A nach EN 62444  
 Schutzart: IP 68 (bis 10 bar) / IP 69  
 Eigenschaften: Für zeitsparende und sichere Montage von partiell abisolierten sowie durchgehend geschirmten Kabeln  
 Einsatztemperatur: -60 °C / +100 °C

Material: Brass CuZn21Si3P lead-free  
 Surface: Nickel-plated  
 Identification: 1 groove  
 Contact spring: Spring steel 1.4310  
 Seal: TPE  
 O-ring: NBR  
 Strain relief: Version A acc. to EN 62444  
 Protection class: IP 68 (up to 10 bar) / IP 69  
 Properties: For a quick and safe installation of partially dismantled cables as well as thoroughly shielded cables  
 Operation temperature: -60 °C / +100 °C



Progress AgreenO  
EMV easyCONNECT



Zweiteiliger Dichteinsatz  
Nicht durchgehend isolierend

Two-piece sealing insert  
not overall length insulated

G	> Ø <	> Ø <	> Ø <	> Ø <	mm	H	L	i	Art.-No.	
	min mm	max mm	min mm	max mm	mm	mm	mm	info		
M12x1.5	-	-	3.5	5.0	15	22	5	1	1083.12.050LF	50
M12x1.5	-	-	5.0	6.5	15	22	5	1	1083.12.065LF	50
M16x1.5	6.0	8.0	8.0	10.5	18	25	5	-	1083.17LF	50
M20x1.5	8.0	11.0	11.0	15.0	24	27	6	-	1083.20LF	50
M25x1.5	12.5	16.0	16.0	20.5	30	33	7	-	1083.25LF	25
M32x1.5	17.0	21.0	21.0	25.5	36	33	8	-	1083.32LF	25
M40x1.5	24.0	28.5	28.5	33.0	46	38	8	-	1083.40LF	10
M50x1.5	33.0	37.0	37.0	42.0	55	42	9	-	1083.50LF	10
M63x1.5	40.0	46.0	46.0	52.0	70	42	10	-	1083.63LF	5

1 = Einteiliger Dichteinsatz

1 = One-piece sealing insert

Auf Anfrage lieferbar:

Available on request:

Anschlussgewinde Pg und NPT

Entry thread Pg and NPT

**Langes Anschlussgewinde metrisch | Long entry thread metric**



Progress AgreenO  
EMV easyCONNECT



Zweiteiliger Dichteinsatz  
Nicht durchgehend isolierend

Two-piece sealing insert  
not overall length insulated

G	> Ø <	> Ø <	> Ø <	> Ø <	mm	H	L	i	Art.-No.	
	min mm	max mm	min mm	max mm	mm	mm	mm	info		
M12x1.5	-	-	3.5	5.0	15	22	10	1	1183.12.050LF	50
M12x1.5	-	-	5.0	6.5	15	22	10	1	1183.12.065LF	50
M16x1.5	6.0	8.0	8.0	10.5	18	25	10	-	1183.17LF	50
M20x1.5	8.0	11.0	11.0	15.0	24	27	10	-	1183.20LF	50
M25x1.5	12.5	16.0	16.0	20.5	30	33	11	-	1183.25LF	25
M32x1.5	17.0	21.0	21.0	25.5	36	33	13	-	1183.32LF	25
M40x1.5	24.0	28.5	28.5	33.0	46	38	13	-	1183.40LF	10
M50x1.5	33.0	37.0	37.0	42.0	55	42	14	-	1183.50LF	10
M63x1.5	40.0	46.0	46.0	52.0	70	42	14	-	1183.63LF	5

1 = Einteiliger Dichteinsatz

1 = One-piece sealing insert

Auf Anfrage lieferbar:

Available on request:

Anschlussgewinde Pg und NPT

Entry thread Pg and NPT

# Kabelverschraubungen Progress® AgreenO EMV Messing bleifrei mit Kontakthülse

## Cable glands Progress® AgreenO EMC nickel-plated brass lead-free with contact sleeve

### Kurzes Anschlussgewinde metrisch | Short entry thread metric

Material:	Messing CuZn21Si3P bleifrei	Material:	Brass CuZn21Si3P lead-free
Oberfläche:	Vernickelt	Surface:	Nickel-plated
Kennzeichnung:	1 Rille	Identification:	1 groove
Kontakthülse:	Messing CuZn21Si3P bleifrei	Contact sleeve:	Brass CuZn21Si3P lead-free
Dichtung:	TPE	Seal:	TPE
O-Ring:	NBR	O-ring:	NBR
Zugentlastung:	Ausführung A nach EN 62444	Strain relief:	Version A acc. to EN 62444
Schutzart:	IP 68 (bis 10 bar) / IP 69	Protection class:	IP 68 (up to 10 bar) / IP 69
Eigenschaften:	Sehr guter Schirmkontakt über die Kontakthülse bei in der Kabelverschraubung endendem Schirmgeflecht	Properties:	Excellent shield contact through the contact sleeve with the braided shield terminating in the screwed cable gland
Einsatztemperatur:	-40 °C / +100 °C	Operation temperature:	-40 °C / +100 °C

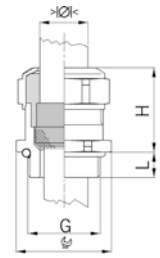

Einteiliger Dichteinsatz  
Nicht durchgehend isolierend

One-piece sealing insert  
not overall length insulated

G	>12< min mm	>12< max mm	 mm	H mm	L mm	Art.-No.	
M12x1.5	4.5	6.0	15	20	5	1080.12.060LF	50
M12x1.5	6.0	7.5	15	20	5	1080.12.075LF	50
M16x1.5	6.0	8.0	18	23	5	1080.17.080LF	50
M16x1.5	8.0	10.0	18	25	5	1080.17.100LF	50
M20x1.5	8.0	11.0	24	25	6	1080.20.110LF	50
M20x1.5	11.0	14.0	24	27	6	1080.20.140LF	50
M25x1.5	13.0	16.0	30	30	7	1080.25.160LF	25
M25x1.5	16.0	19.0	30	33	7	1080.25.190LF	25
M32x1.5	18.0	21.0	36	32	8	1080.32.210LF	25
M32x1.5	21.0	25.0	36	32	8	1080.32.250LF	25
M40x1.5	24.0	28.5	46	34	8	1080.40.285LF	10
M40x1.5	28.5	32.0	46	34	8	1080.40.320LF	10
M50x1.5	33.0	37.0	55	36	9	1080.50.370LF	10
M50x1.5	37.0	41.0	55	36	9	1080.50.410LF	10
M63x1.5	40.0	46.0	70	39	10	1080.63.460LF	5
M63x1.5	46.0	50.0	70	39	10	1080.63.500LF	5

Auf Anfrage lieferbar:  
Anschlussgewinde Pg und NPT

Available on request:  
Entry thread Pg and NPT



# Kabelverschraubungen Progress® AgreenO EMV Messing bleifrei mit Kontakthülse

## Cable glands Progress® AgreenO EMC nickel-plated brass lead-free with contact sleeve

### Langes Anschlussgewinde metrisch | Long entry thread metric

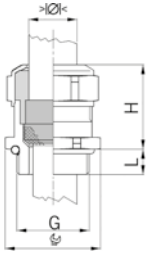

Material: Messing CuZn21Si3P bleifrei  
 Oberfläche: Vernickelt  
 Kennzeichnung: 1 Rille  
 Kontakthülse: Messing CuZn21Si3P bleifrei  
 Dichtung: TPE  
 O-Ring: NBR  
 Zugentlastung: Ausführung A nach EN 62444  
 Schutzart: IP 68 (bis 10 bar) / IP 69  
 Eigenschaften: Sehr guter Schirmkontakt über die Kontakthülse bei in der Kabelverschraubung endendem Schirmgeflecht

Material: Brass CuZn21Si3P lead-free  
 Surface: Nickel-plated  
 Identification: 1 groove  
 Contact sleeve: Brass CuZn21Si3P lead-free  
 Seal: TPE  
 O-ring: NBR  
 Strain relief: Version A acc. to EN 62444  
 Protection class: IP 68 (up to 10 bar) / IP 69  
 Properties: Excellent shield contact through the contact sleeve with the braided shield terminating in the screwed cable gland

Einsatztemperatur: -40 °C / +100 °C

Operation temperature: -40 °C / +100 °C



Einteiliger Dichteinsatz  
 Nicht durchgehend isolierend

One-piece sealing insert  
 not overall length insulated

G	$\varnothing$		$\varnothing$	H	L	Art.-No.	
	min mm	max mm					
M12x1.5	4.5	6.0	15	20	10	1180.12.060LF	50
M12x1.5	6.0	7.5	15	20	10	1180.12.075LF	50
M16x1.5	6.0	8.0	18	23	10	1180.17.080LF	50
M16x1.5	8.0	10.0	18	25	10	1180.17.100LF	50
M20x1.5	8.0	11.0	24	25	10	1180.20.110LF	50
M20x1.5	11.0	14.0	24	27	10	1180.20.140LF	50
M25x1.5	13.0	16.0	30	30	11	1180.25.160LF	25
M25x1.5	16.0	19.0	30	33	11	1180.25.190LF	25
M32x1.5	18.0	21.0	36	32	13	1180.32.210LF	25
M32x1.5	21.0	25.0	36	32	13	1180.32.250LF	25
M40x1.5	24.0	28.5	46	34	13	1180.40.285LF	10
M40x1.5	28.5	32.0	46	34	13	1180.40.320LF	10
M50x1.5	33.0	37.0	55	36	14	1180.50.370LF	10
M50x1.5	37.0	41.0	55	36	14	1180.50.410LF	10
M63x1.5	40.0	46.0	70	39	14	1180.63.460LF	5
M63x1.5	46.0	50.0	70	39	14	1180.63.500LF	5

Auf Anfrage lieferbar:  
 Anschlussgewinde Pg und NPT

Available on request:  
 Entry thread Pg and NPT



# EMV-Gegenmutter AgreenO Messing bleifrei mit Schneidezähnen



## EMC Lock nuts AgreenO nickel-plated brass lead-free with cutter teeth

### Anschlussgewinde metrisch | Entry thread metric

Material: Messing CuZn21Si3P bleifrei  
 Oberfläche: Vernickelt  
 Kennzeichnung: 1 Rille  
 Ausführung: 6-kant  
 Einsatztemperatur: -60 °C / +200 °C

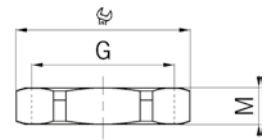
Material: Brass CuZn21Si3P lead-free  
 Surface: Nickel-plated  
 Identification: 1 groove  
 Execution: Hexagonal design  
 Operation temperature: -60 °C / +200 °C



Gewinde metrisch			Metric thread	
G	 mm	M mm	Art.-No.	
M12x1.5	15	3.5	8000.12LF	100
M16x1.5	19	3.5	8000.17LF	100
M20x1.5	24	4.0	8000.20LF	100
M25x1.5	30	4.0	8000.25LF	50
M32x1.5	36	5.0	8000.32LF	25
M40x1.5	46	5.3	8000.40LF	25
M50x1.5	55	6.3	8000.50LF	10
M63x1.5	70	7.0	8000.63LF	10

Auf Anfrage lieferbar: Anschlussgewinde Pg  
 Available on request: Entry thread Pg





### Anschlussgewinde metrisch | Entry thread metric

Material: Messing CuZn21Si3P bleifrei  
 Oberfläche: Vernickelt  
 Kennzeichnung: 1 Rille  
 Ausführung: 6-kant  
 Eigenschaften: EMV-Gegenmutter mit Schneidezähnen für eine optimale Kontaktierung  
 Einsatztemperatur: -60 °C / +200 °C

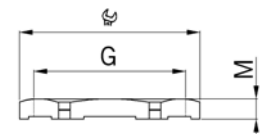
Material: Brass CuZn21Si3P lead-free  
 Surface: Nickel-plated  
 Identification: 1 groove  
 Execution: Hexagonal design  
 Properties: EMC lock nut with cutting teeth for optimised shield contact  
 Operation temperature: -60 °C / +200 °C



Gewinde metrisch			Metric thread	
G	 mm	M mm	Art.-No.	
M12x1.5	15	3.0	8012.85LF	25
M16x1.5	19	3.0	8017.85LF	25
M20x1.5	24	3.5	8020.85LF	25
M25x1.5	30	4.0	8025.85LF	10
M32x1.5	36	4.0	8032.85LF	10
M40x1.5	46	5.0	8040.85LF	10
M50x1.5	55	5.5	8050.85LF	10
M63x1.5	70	6.0	8063.85LF	10

Auf Anfrage lieferbar: Anschlussgewinde Pg  
 Available on request: Entry thread Pg



# AGRO Kombi-Schlauchverschraubung aus Messing

## AGRO Combination conduit gland nickel-plated brass

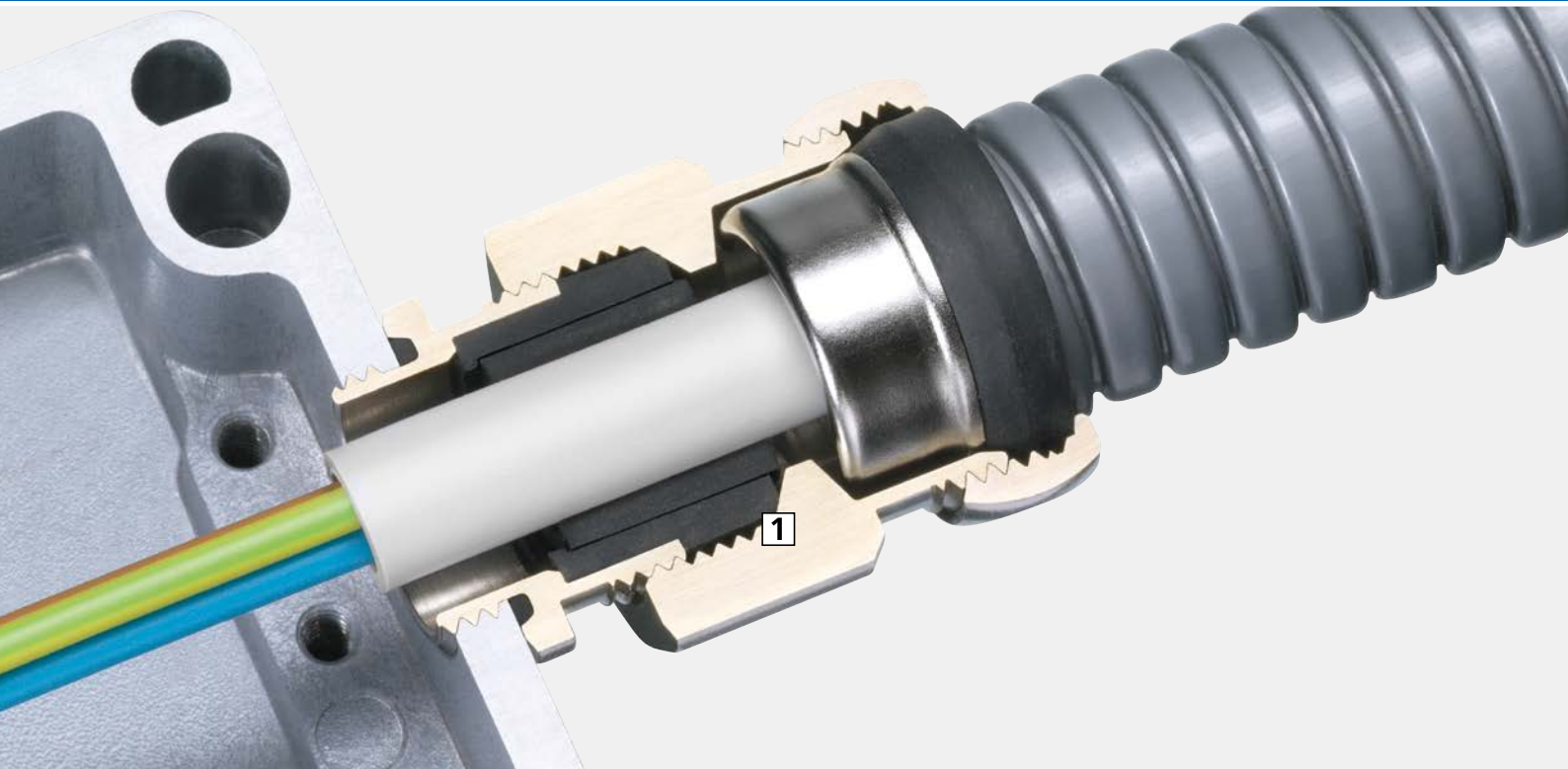

AGRO Kombi-Schlauchverschraubungen sind eine optimale Lösung, wenn Sie Kabel in einem Schutzschlauch in ein Gehäuse einführen wollen und gleichzeitig eine sichere Abdichtung und Zugentlastung des Kabels möchten.

### 1 Dichtheit

Mit der integrierten Kabelverschraubung erzielen Sie eine hervorragende Dichtheit (IP 68) im Innenbereich des Schutzschlauchs. So verhindern Sie das Eindringen von Flüssigkeiten und Kondenswasser.

### Integrierte EMV-Kabelverschraubung

Die Kombi-Schlauchverschraubung gibt es auch als kombinierte Variante für geschirmte Kabel.

Kommen Kombi-Schlauchverschraubungen in **Bahnapplikationen** zum Einsatz – etwa weil Kabel in Schutzschläuchen geführt werden, um sie vor Schlägen oder Manipulation zu schützen – so gelten für sie die selben Anforderungen wie für Kabelverschraubungen: sie müssen mit einem Dichteinsatz aus Spezial-TPE gemäss **EN 45545** bestückt werden.

AGRO combination conduit glands are an optimal solution if you want to route cables inside a conduit into an enclosure and at the same time want a secure seal and strain relief for the cables.

### 1 Sealing capability







The integrated cable gland achieves excellent sealing (IP 68) inside the conduit. In this way, you make certain that water and condensate cannot make its way inside.

### Integrated EMC cable gland

The combination conduit gland is also available in a special version for shielded cables.

In cases where combination conduit glands are used for **railway applications** – for instance when cables are laid in conduits in order to protect them from impacts or tampering – the same requirements apply as for cable glands: the combination conduit glands must be equipped with a sealing insert made of special TPE according to the requirements of **EN 45545**.



AGRO Kombi-Schlauchverschraubung Progress® Messing mit integrierter Kabelverschraubung AGRO Combination conduit glands Progress® nickel-plated brass with integrated cable gland	 <b>208 - 211</b>	1
AGRO Adapter Progress® Messing mit integrierter Kabelverschraubung AGRO Adapter Progress® nickel-plated brass with integrated cable gland	 <b>212 - 213</b>	2
AGRO Kombi-Schlauchverschraubung Progress® EMV Messing mit integrierter Kabelverschraubung AGRO Combination conduit glands Progress® EMC nickel-plated brass with integrated cable gland	 <b>214 - 216</b>	3
AGRO Adapter Progress® Messing mit integrierter EMV-Kabelverschraubung AGRO Adapters Progress® nickel-plated brass with integrated EMC cable gland	 <b>217 - 218</b>	4
AGRO Kombi-EMV-Schlauchverschraubung für Kupfer-Hohlgeflechte AGRO Combination EMC conduit gland for copper braidings	 <b>219</b>	5
Zubehör zu Schlauchverschraubungen Conduit gland accessories	 <b>220</b>	6

- 1
- 2
- 3
- 4
- 5
- 6
- 7
- 8
- 9
- 10
- 11
- 12
- 13
- 14
- 15

Kurzes Anschlussgewinde metrisch | Short entry thread metric

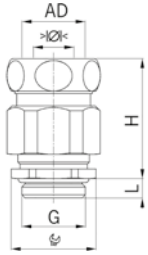

Material:	Messing vernickelt	Material:	Nickel-plated brass
Dichtung:	TPE	Seal:	TPE
O-Ring:	NBR	O-ring:	NBR
Zugentlastung:	Ausführung A nach EN 62444	Strain relief:	Version A acc. to EN 62444
Schutzart:	Kabelverschraubung IP 68	Protection class:	Cable gland IP 68
Hinweis:	Der max. Klemmbereich ist abhängig vom Schlauch-Innendurchmesser	Note:	The max. clamping range depends on the conduit inner diameter
Einsatztemperatur:	-40 °C / +100 °C	Operation temperature:	-40 °C / +100 °C



Progress MS Kombi



Für Schlauchanschluss AD mm  
 Zweiteiliger Dichteinsatz  
 Nicht durchgehend isolierend

Connector for tubing with AD mm  
 Two-piece sealing insert  
 not overall length insulated

G	AD mm	> < < min mm	> < < max mm	> < < min mm	> < < max mm	 mm	H mm	L mm	Art.-No.	
M12x1.5	10	-	-	5.0	6.5	15/17	33	5	1700.12.10	50
M16x1.5	14	6.0	8.0	8.0	10.5	18/21	38	5	1700.17.14	50
M20x1.5	17	8.0	11.0	11.0	15.0	24/25	38	6	1700.20.17	25
M20x1.5	19	8.0	11.0	11.0	15.0	24/27	39	6	1700.20.19	25
M20x1.5	21	8.0	11.0	11.0	15.0	24/29	39	6	1700.20.21	25
M25x1.5	21	12.5	16.0	16.0	20.5	30/29	43	7	1700.25.21	25
M25x1.5	27	12.5	16.0	16.0	20.5	30/36	50	7	1700.25.27	25
M32x1.5	27	17.0	21.0	21.0	25.5	36/36	52	8	1700.32.27	25
M40x1.5	36	24.0	28.5	28.5	33.0	46/45	56	8	1700.40.36	10
M50x1.5	45	33.0	37.0	37.0	42.0	55/54	60	9	1700.50.45	10
M63x1.5	56	40.0	46.0	46.0	52.0	70/66	67	10	1700.63.56	5

Je nach Schlauchtyp muss die passende Stabilisierungshülse separat bestellt werden.

Depending on the type of conduit, the stabilising bush must be ordered separately.

Erhältlich mit Dichteinsatz gemäss EN 45545 / NFPA 130. Bei Anfragen oder Bestellung bitte ein F vor die Artikelnummer setzen.

Available with sealing inserts conformity with EN 45545 / NFPA 130. When placing an inquiry, prefix the article number by the capital F.

Für Schlauchanschluss AD Zoll  
 Zweiteiliger Dichteinsatz  
 Nicht durchgehend isolierend

Connector for tubing with AD in inches  
 Two-piece sealing insert  
 not overall length insulated

G	AD mm	> < < min mm	> < < max mm	> < < min mm	> < < max mm	 mm	H mm	L mm	Art.-No.	
M12x1.5	1/4"	-	-	5.0	6.5	15/19	35	5	1700.12.1/4	50
M20x1.5	3/8"	8.0	11.0	11.0	15.0	24/27	42	6	1700.20.3/8	25
M20x1.5	1/2"	8.0	11.0	11.0	15.0	24/29	38	6	1700.20.1/2	25
M25x1.5	3/4"	12.5	16.0	16.0	20.5	30/36	52	7	1700.25.3/4	25
M32x1.5	1"	17.0	21.0	21.0	25.5	36/45	55	8	1700.32.1	25
M40x1.5	1 1/4"	24.0	28.5	28.5	33.0	46/54	62	8	1700.40.11/4	10
M63x1.5	2"	40.0	46.0	46.0	52.0	70/70	74	10	1700.63.2	5

Je nach Schlauchtyp muss die passende Stabilisierungshülse separat bestellt werden.

Depending on the type of conduit, the stabilising bush must be ordered separately.

Erhältlich mit Dichteinsatz gemäss EN 45545 / NFPA 130. Bei Anfragen oder Bestellung bitte ein F vor die Artikelnummer setzen.

Available with sealing inserts conformity with EN 45545 / NFPA 130. When placing an inquiry, prefix the article number by the capital F.

**Langes Anschlussgewinde metrisch | Long entry thread metric**

Material:	Messing vernickelt	Material:	Nickel-plated brass
Dichtung:	TPE	Seal:	TPE
O-Ring:	NBR	O-ring:	NBR
Zugentlastung:	Ausführung A nach EN 62444	Strain relief:	Version A acc. to EN 62444
Schutzart:	Kabelverschraubung IP 68	Protection class:	Cable gland IP 68
Hinweis:	Der max. Klemmbereich ist abhängig vom Schlauch-Innendurchmesser	Note:	The max. clamping range depends on the conduit inner diameter
Einsatztemperatur:	-40 °C / +100 °C	Operation temperature:	-40 °C / +100 °C

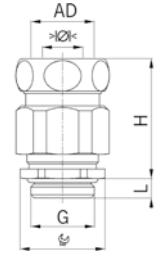

Für Schlauchanschluss AD mm Zweiteiliger Dichteinsatz Durchgehend isolierend								Connector for tubing with AD mm Two-piece sealing insert overall length insulated			
G	AD	> Ø <	> Ø <	> Ø <	> Ø <	Ⓜ	H	L	Art.-No.	📦	
	mm	min mm	max mm	min mm	max mm	mm	mm	mm			
<b>M12x1.5</b>	10	-	-	5.0	6.5	15/17	33	10	<b>1710.60.12.10</b>	50	
<b>M16x1.5</b>	14	6.0	8.0	8.0	10.5	18/21	38	10	<b>1710.60.17.14</b>	50	
<b>M20x1.5</b>	17	8.0	11.0	11.0	14.5	24/25	38	10	<b>1710.60.20.17</b>	25	
<b>M20x1.5</b>	19	8.0	11.0	11.0	14.5	24/27	39	10	<b>1710.60.20.19</b>	25	
<b>M20x1.5</b>	21	8.0	11.0	11.0	14.5	24/29	39	10	<b>1710.60.20.21</b>	25	
<b>M25x1.5</b>	21	12.5	16.0	16.0	19.0	30/29	43	11	<b>1710.60.25.21</b>	25	
<b>M25x1.5</b>	27	12.5	16.0	16.0	19.0	30/36	50	11	<b>1710.60.25.27</b>	25	
<b>M32x1.5</b>	27	17.0	21.0	21.0	25.5	36/36	52	13	<b>1710.60.32.27</b>	25	
<b>M40x1.5</b>	36	24.0	28.5	28.5	33.0	46/45	56	13	<b>1710.60.40.36</b>	10	
<b>M50x1.5</b>	45	33.0	37.0	37.0	42.0	55/54	60	14	<b>1710.60.50.45</b>	10	
<b>M63x1.5</b>	56	40.0	46.0	46.0	52.0	70/66	67	14	<b>1710.60.63.56</b>	5	

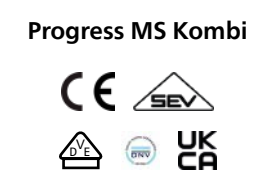

Für Schlauchanschluss AD Zoll Zweiteiliger Dichteinsatz Durchgehend isolierend								Connector for tubing with AD in inches Two-piece sealing insert overall length insulated			
G	AD	> Ø <	> Ø <	> Ø <	> Ø <	Ⓜ	H	L	Art.-No.	📦	
	mm	min mm	max mm	min mm	max mm	mm	mm	mm			
<b>M12x1.5</b>	1/4"	-	-	5.0	6.5	15/19	35	10	<b>1710.60.12.1/4</b>	50	
<b>M20x1.5</b>	3/8"	8.0	11.0	11.0	14.5	24/27	42	10	<b>1710.60.20.3/8</b>	25	
<b>M20x1.5</b>	1/2"	8.0	11.0	11.0	14.5	24/29	38	10	<b>1710.60.20.1/2</b>	25	
<b>M25x1.5</b>	3/4"	12.5	16.0	16.0	19.0	30/36	52	11	<b>1710.60.25.3/4</b>	25	
<b>M32x1.5</b>	1"	12.5	16.0	16.0	19.0	36/45	55	13	<b>1710.60.32.1</b>	25	
<b>M40x1.5</b>	1 1/4"	24.0	28.5	28.5	33.0	46/54	62	13	<b>1710.60.40.11/4</b>	10	
<b>M63x1.5</b>	2"	40.0	46.0	46.0	52.0	70/70	74	14	<b>1710.60.63.2</b>	5	

**Kurzes Anschlussgewinde Pg | Short entry thread Pg**

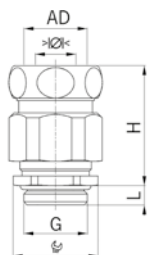

Material: Messing vernickelt  
 Dichtung: TPE  
 O-Ring: NBR  
 Schutzart: Kabelverschraubung IP 68  
 Hinweis: Der max. Klemmbereich ist abhängig vom Schlauch-Innendurchmesser  
 Einsatztemperatur: -40 °C / +100 °C

Material: Nickel-plated brass  
 Seal: TPE  
 O-ring: NBR  
 Protection class: Cable gland IP 68  
 Note: The max. clamping range depends on the conduit inner diameter  
 Operation temperature: -40 °C / +100 °C



Progress MS Kombi

UK  
CA

Für Schlauchanschluss AD mm  
 Zweiteiliger Dichteinsatz  
 Nicht durchgehend isolierend

Connector for tubing with AD mm  
 Two-piece sealing insert  
 not overall length insulated

G	AD mm	>∅< min mm	>∅< max mm	>∅< min mm	>∅< max mm	mm	H mm	L mm	Art.-No.	
Pg 7	10	-	-	5.0	6.5	15/17	33	6	1700.07.10	50
Pg 9	14	6.0	8.0	8.0	10.5	18/21	38	6	1700.09.14	50
Pg 11	14	5.5	8.5	8.5	12.0	21/21	39	6	1700.11.14	50
Pg 11	17	5.5	8.5	8.5	12.0	21/25	39	6	1700.11.17	50
Pg 13	19	8.0	11.0	11.0	15.0	24/27	39	6	1700.13.19	25
Pg 16	17	8.0	11.0	11.0	15.0	24/25	38	6	1700.16.17	25
Pg 16	21	8.0	11.0	11.0	15.0	24/29	39	6	1700.16.21	25
Pg 21	27	12.5	16.0	16.0	20.5	30/36	50	7.5	1700.21.27	25
Pg 29	36	19.0	23.0	23.0	27.5	38/45	55	8	1700.29.36	25
Pg 36	45	26.0	30.5	30.5	35.0	50/54	60	8	1700.36.45	10
Pg 42	45	33.0	37.0	37.0	42.0	55/54	60	10	1700.42.45	10
Pg 48	56	37.0	43.0	43.0	49.0	65/66	67	11	1700.48.56	10

Je nach Schlauchtyp muss die passende Stabilisierungshülse separat bestellt werden.

Depending on the type of conduit, the stabilising bush must be ordered separately.

Erhältlich mit Dichteinsatz gemäss EN 45545 / NFPA 130. Bei Anfragen oder Bestellung bitte ein F vor die Artikelnummer setzen.

Available with sealing inserts conformity with EN 45545 / NFPA 130. When placing an inquiry, prefix the article number by the capital F.

**Langes Anschlussgewinde Pg | Long entry thread Pg**



Progress MS Kombi

UK  
CA

Für Schlauchanschluss AD mm  
 Zweiteiliger Dichteinsatz  
 Durchgehend isolierend

Connector for tubing with AD mm  
 Two-piece sealing insert  
 overall length insulated

G	AD mm	>∅< min mm	>∅< max mm	>∅< min mm	>∅< max mm	mm	H mm	L mm	Art.-No.	
Pg 7	10	-	-	5.0	6.5	15/17	33	10	1710.60.07.10	50
Pg 9	14	6.0	8.0	8.0	10.5	18/21	38	10	1710.60.09.14	50
Pg 11	14	5.5	8.5	8.5	12.0	21/21	39	10	1710.60.11.14	50
Pg 11	17	5.5	8.5	8.5	12.0	21/25	39	10	1710.60.11.17	50
Pg 13	19	8.0	11.0	11.0	14.5	24/27	39	10	1710.60.13.19	25
Pg 16	17	8.0	11.0	11.0	14.5	24/25	38	10	1710.60.16.17	25
Pg 16	21	8.0	11.0	11.0	14.5	24/29	39	10	1710.60.16.21	25
Pg 21	27	12.5	16.0	16.0	19.0	30/36	50	12	1710.60.21.27	25
Pg 29	36	19.0	23.0	23.0	27.5	38/45	55	12	1710.60.29.36	25
Pg 36	45	26.0	30.5	30.5	35.0	50/54	60	15	1710.60.36.45	10
Pg 42	45	33.0	37.0	37.0	42.0	55/54	60	15	1710.60.42.45	10
Pg 48	56	37.0	43.0	43.0	49.0	65/66	67	15	1710.60.48.56	10

Je nach Schlauchtyp muss die passende Stabilisierungshülse separat bestellt werden.

Depending on the type of conduit, the stabilising bush must be ordered separately.

Erhältlich mit Dichteinsatz gemäss EN 45545 / NFPA 130. Bei Anfragen oder Bestellung bitte ein F vor die Artikelnummer setzen.

Available with sealing inserts conformity with EN 45545 / NFPA 130. When placing an inquiry, prefix the article number by the capital F.

# Hydraulischlauch Adapter Progress® Messing

## Hydraulic hose adapter Progress® brass

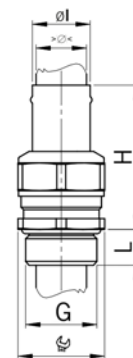

### Langes Anschlussgewinde metrisch | Long entry thread metric

Material:	Messing vernickelt	Material:	Nickel-plated brass
Dichtung:	Spezial AGRO TPE hellgrau	Seal:	Special AGRO TPE light grey
Zugentlastung:	Ausführung A nach EN 62444	Strain relief:	Version A acc. to EN 62444
Schutzart:	IP 68 (bis 10 bar) / IP 69	Protection class:	IP 68 (up to 10 bar) / IP 69
Einsatztemperatur:	-50 °C / +105 °C	Operation temperature:	-50 °C / +105 °C



Mehrteiliger Dichteinsatz  
Nicht durchgehend isolierend  
Schutzart IP 69 zu Schlauch

Multi-piece sealing insert  
not overall length insulated  
Protection class IP 69 for hose

G	$\begin{matrix} >ØI< \\ \text{min mm} & \text{max mm} \end{matrix}$		ØI mm	 mm	H mm	L mm	Art.-No.	
	min mm	max mm						
M20x1.5	4	14.5	16	24/24	40	10	F1731.4.20.16	25
M25x1.5	4	14.5	16	24/30	40	15	F1731.4.25.16	25
M32x1.5	10	23.5	25	36/36	53	13	F1731.4.32.25	25



EN 45545-2  
HL 3



1  
2  
3  
4  
5  
6  
7  
8  
9  
10  
11  
12  
13  
14  
15

# AGRO Adapter Progress® Messing mit integrierter Kabelverschraubung

## AGRO Adapter Progress® nickel-plated brass with integrated cable gland

### Langes Anschlussgewinde metrisch | Long entry thread metric

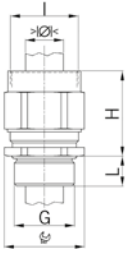

Material:	Messing vernickelt	Material:	Nickel-plated brass
Dichtung:	TPE	Seal:	TPE
O-Ring:	NBR	O-ring:	NBR
Zugentlastung:	Ausführung A nach EN 62444	Strain relief:	Version A acc. to EN 62444
Schutzart:	Kabelverschraubung IP 68	Protection class:	Cable gland IP 68
Hinweis:	Der max. Klemmbereich ist abhängig vom Schlauch-Innendurchmesser	Note:	The max. clamping range depends on the conduit inner diameter
Einsatztemperatur:	-40 °C / +100 °C	Operation temperature:	-40 °C / +100 °C



Progress MS Adapter



Einteiliger Dichteinsatz  
Durchgehend isolierend

One-piece sealing insert  
overall length insulated

G	I	> Ø <	> Ø <	Ø	H	L	i	Art.-No.	
		min mm	max mm	mm	mm	mm	info		
<b>M10x1.5</b>	M10x1.5	4.0	6.0	13	30	10	1	<b>1165.10</b>	50
<b>M12x1.5</b>	M12x1.5	5.0	6.5	15	32	10	-	<b>1165.12</b>	50

1 = Metrisches Regelgewinde (mit VDE Testreport)

1 = Metric coarse-pitch thread (with VDE test report)

Erhältlich mit Dichteinsatz gemäss EN 45545 / NFPA 130. Bei Anfragen oder Bestellung bitte ein F vor die Artikelnummer setzen.

Available with sealing inserts conformity with EN 45545 / NFPA 130. When placing an inquiry, prefix the article number by the capital F.

Zweiteiliger Dichteinsatz  
Durchgehend isolierend

Two-piece sealing insert  
overall length insulated

G	I	> Ø <	> Ø <	> Ø <	> Ø <	Ø	H	L	Art.-No.	
		min mm	max mm	min mm	max mm	mm	mm	mm		
<b>M16x1.5</b>	M16x1.5	6.0	8.0	8.0	10.5	18	35	10	<b>1165.17</b>	50
<b>M20x1.5</b>	M20x1.5	8.0	11.0	11.0	14.5	24	36	10	<b>1165.20</b>	25
<b>M25x1.5</b>	M25x1.5	12.5	16.0	16.0	19.0	30	41	11	<b>1165.25</b>	25
<b>M32x1.5</b>	M32x1.5	17.0	21.0	21.0	25.5	36	46	13	<b>1165.32</b>	25
<b>M40x1.5</b>	M40x1.5	24.0	28.5	28.5	33.0	46	48	13	<b>1165.40</b>	10
<b>M50x1.5</b>	M50x1.5	33.0	37.0	37.0	42.0	55	53	14	<b>1165.50</b>	5
<b>M63x1.5</b>	M63x1.5	40.0	46.0	46.0	52.0	70	56	14	<b>1165.63</b>	5

Erhältlich mit Dichteinsatz gemäss EN 45545 / NFPA 130. Bei Anfragen oder Bestellung bitte ein F vor die Artikelnummer setzen.

Available with sealing inserts conformity with EN 45545 / NFPA 130. When placing an inquiry, prefix the article number by the capital F.

# AGRO Adapter Progress® Messing mit integrierter Kabelverschraubung

## AGRO Adapter Progress® nickel-plated brass with integrated cable gland

### Langes Anschlussgewinde Pg | Long entry thread Pg

Material:	Messing vernickelt	Material:	Nickel-plated brass
Dichtung:	TPE	Seal:	TPE
O-Ring:	NBR	O-ring:	NBR
Schutzart:	Kabelverschraubung IP 68	Protection class:	Cable gland IP 68
Hinweis:	Der max. Klemmbereich ist abhängig vom Schlauch-Innendurchmesser	Note:	The max. clamping range depends on the conduit inner diameter
Einsatztemperatur:	-40 °C / +100 °C	Operation temperature:	-40 °C / +100 °C

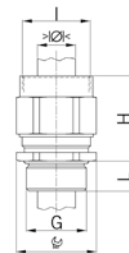

Einteiliger Dichteinsatz Durchgehend isolierend		One-piece sealing insert overall length insulated							
<b>G</b>	<b>I</b>	$\varnothing_{\text{min}}$	$\varnothing_{\text{max}}$	$\varnothing_{\text{mm}}$	<b>H</b>	<b>L</b>	<b>Art.-No.</b>		
<b>Pg 7</b>	Pg 7	5.0	6.5	15	30	10	<b>1165.07</b>	50	
Erhältlich mit Dichteinsatz gemäss EN 45545 / NFPA 130. Bei Anfragen oder Bestellung bitte ein F vor die Artikelnummer setzen.				Available with sealing inserts conformity with EN 45545 / NFPA 130. When placing an inquiry, prefix the article number by the capital F.					



Progress MS Adapter

UK  
CA

Zweiteiliger Dichteinsatz Durchgehend isolierend		Two-piece sealing insert overall length insulated								
<b>G</b>	<b>I</b>	$\varnothing_{\text{min}}$	$\varnothing_{\text{max}}$	$\varnothing_{\text{min}}$	$\varnothing_{\text{max}}$	$\varnothing_{\text{mm}}$	<b>H</b>	<b>L</b>	<b>Art.-No.</b>	
<b>Pg 9</b>	Pg 9	6.0	8.0	8.0	10.5	18	35	10	<b>1165.09</b>	50
<b>Pg 11</b>	Pg 11	5.5	8.5	8.5	12.0	21	36	10	<b>1165.11</b>	50
<b>Pg 13</b>	Pg 13	8.0	11.0	11.0	14.5	24	36	10	<b>1165.13</b>	25
<b>Pg 16</b>	Pg 16	8.0	11.0	11.0	14.5	24	37	10	<b>1165.16</b>	25
<b>Pg 21</b>	Pg 21	12.5	16.0	16.0	19.0	30	42	12	<b>1165.21</b>	25
<b>Pg 29</b>	Pg 29	19.0	23.0	23.0	27.5	38/40	45	12	<b>1165.29</b>	25
<b>Pg 36</b>	Pg 36	26.0	30.5	30.5	35.0	50	52	15	<b>1165.36</b>	10
<b>Pg 48</b>	Pg 48	37.0	43.0	43.0	49.0	65	56	15	<b>1165.48</b>	5
Erhältlich mit Dichteinsatz gemäss EN 45545 / NFPA 130. Bei Anfragen oder Bestellung bitte ein F vor die Artikelnummer setzen.				Available with sealing inserts conformity with EN 45545 / NFPA 130. When placing an inquiry, prefix the article number by the capital F.						

Langes Anschlussgewinde metrisch | Long entry thread metric

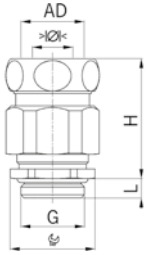

Material:	Messing vernickelt	Material:	Nickel-plated brass
Dichtung:	TPE	Seal:	TPE
O-Ring:	NBR	O-ring:	NBR
Zugentlastung:	Ausführung A nach EN 62444	Strain relief:	Version A acc. to EN 62444
Schutzart:	Kabelverschraubung IP 68	Protection class:	Cable gland IP 68
Hinweis:	Der max. Klemmbereich ist abhängig vom Schlauch-Innendurchmesser	Note:	The max. clamping range depends on the conduit inner diameter
Eigenschaften:	Sehr guter Schirmkontakt über die Kontakthülse bei in der Kabelverschraubung endendem Schirmgeflecht	Properties:	Excellent shield contact through the contact sleeve with the braided shield terminating in the screwed cable gland
Einsatztemperatur:	-40 °C / +100 °C	Operation temperature:	-40 °C / +100 °C



Progress MS Kombi  
EMC



Einteiliger Dichteinsatz  
Nicht durchgehend isolierend

One-piece sealing insert  
not overall length insulated

G	AD mm	>101< min mm	>101< max mm	 mm	H mm	L mm	Art.-No.	
M12x1.5	10	4.5	6.0	15-17	35	10	1710.80.12.060.1	25
M16x1.5	14	6.0	8.0	18/21	40	10	1710.80.17.080.1	25
M16x1.5	14	8.0	10.0	18/21	40	10	1710.80.17.100.1	25
M20x1.5	17	8.0	11.0	24/25	42	10	1710.80.20.110.1	25
M20x1.5	17	11.0	14.0	24/25	42	10	1710.80.20.140.1	25
M20x1.5	19	8.0	11.0	24/27	43	10	1710.80.20.110.2	25
M20x1.5	19	11.0	14.0	24/27	43	10	1710.80.20.140.2	25
M25x1.5	21	13.0	16.0	30/29	48	11	1710.80.25.160.1	25
M25x1.5	27	16.0	19.0	30/36	52	11	1710.80.25.190.1	25
M32x1.5	27	18.0	21.0	36/36	55	13	1710.80.32.210.1	10
M32x1.5	27	21.0	25.0	36/36	55	13	1710.80.32.250.1	10
M40x1.5	36	24.0	28.5	46/45	60	13	1710.80.40.285.1	10
M40x1.5	36	28.5	32.0	46/45	60	13	1710.80.40.320.1	10
M50x1.5	45	33.0	37.0	55/54	62	14	1710.80.50.370.1	5
M50x1.5	45	37.0	41.0	55/54	62	14	1710.80.50.410.1	5
M63x1.5	56	40.0	46.0	70/66	69	14	1710.80.63.460.1	5
M63x1.5	56	46.0	50.0	70/66	69	14	1710.80.63.500.1	5

Je nach Schlauchtyp muss die passende Stabilisierungshülse separat bestellt werden.

Depending on the type of conduit, the stabilising bush must be ordered separately.

Erhältlich mit Dichteinsatz gemäss EN 45545 / NFPA 130. Bei Anfragen oder Bestellung bitte ein F vor die Artikelnummer setzen.

Available with sealing inserts conformity with EN 45545 / NFPA 130. When placing an inquiry, prefix the article number by the capital F.

**Langes Anschlussgewinde metrisch | Long entry thread metric**

Material:	Messing vernickelt	Material:	Nickel-plated brass
Dichtung:	TPE	Seal:	TPE
O-Ring:	NBR	O-ring:	NBR
Zugentlastung:	Ausführung A nach EN 62444	Strain relief:	Version A acc. to EN 62444
Schutzart:	Kabelverschraubung IP 68	Protection class:	Cable gland IP 68
Hinweis:	Der max. Klemmbereich ist abhängig vom Schlauch-Innendurchmesser	Note:	The max. clamping range depends on the conduit inner diameter
Eigenschaften:	Sehr guter Schirmkontakt über die Kontakthülse bei in der Kabelverschraubung endendem Schirmgeflecht	Properties:	Excellent shield contact through the contact sleeve with the braided shield terminating in the screwed cable gland
Einsatztemperatur:	-40 °C / +100 °C	Operation temperature:	-40 °C / +100 °C

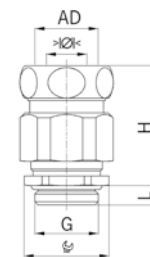

Einteiliger Dichteinsatz Nicht durchgehend isolierend							One-piece sealing insert not overall length insulated		
G	AD mm	>D< min mm	<D< max mm	Ø mm	H mm	L mm	Art.-No.		
M12x1.5	1/4"	4.5	6.0	15/19	35	10	1710.80.12.060.2	25	
M16x1.5	5/16"	6.0	8.0	18/21	38	10	1710.80.17.080.2	25	
M16x1.5	5/16"	8.0	10.0	18/21	38	10	1710.80.17.100.2	25	
M20x1.5	3/8"	8.0	11.0	24/27	42	10	1710.80.20.110.3	25	
M20x1.5	1/2"	8.0	11.0	24/29	38	10	1710.80.20.110.4	25	
M20x1.5	1/2"	11.0	14.0	24/29	38	10	1710.80.20.140.4	25	
M25x1.5	3/4"	13.0	16.0	30/36	52	11	1710.80.25.160.2	25	
M25x1.5	3/4"	16.0	19.0	30/36	52	11	1710.80.25.190.2	25	
M32x1.5	1"	18.0	21.0	36/45	55	13	1710.80.32.210.2	10	
M32x1.5	1"	21.0	25.0	36/45	55	13	1710.80.32.250.2	10	
M40x1.5	1 1/4"	24.0	28.5	46/54	62	13	1710.80.40.285.2	10	
M40x1.5	1 1/4"	28.5	32.0	46/54	62	13	1710.80.40.320.2	10	
M63x1.5	2"	40.0	46.0	70/70	74	14	1710.80.63.460.2	5	
M63x1.5	2"	46.0	50.0	70/70	74	14	1710.80.63.500.2	5	

Je nach Schlauchtyp muss die passende Stabilisierungshülse separat bestellt werden.  
 Erhältlich mit Dichteinsatz gemäss EN 45545 / NFPA 130. Bei Anfragen oder Bestellung bitte ein F vor die Artikelnummer setzen.

Depending on the type of conduit, the stabilising bush must be ordered separately.  
 Available with sealing inserts conformity with EN 45545 / NFPA 130. When placing an inquiry, prefix the article number by the capital F.



**Progress MS Kombi EMC**



Langes Anschlussgewinde Pg | Long entry thread Pg

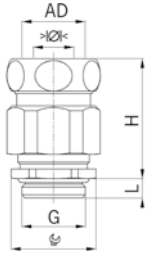

Material:	Messing vernickelt	Material:	Nickel-plated brass
Dichtung:	TPE	Seal:	TPE
O-Ring:	NBR	O-ring:	NBR
Schutzart:	Kabelverschraubung IP 68	Protection class:	Cable gland IP 68
Hinweis:	Der max. Klemmbereich ist abhängig vom Schlauch-Innendurchmesser	Note:	The max. clamping range depends on the conduit inner diameter
Eigenschaften:	Sehr guter Schirmkontakt über die Kontakthülse bei in der Kabelverschraubung endendem Schirmgeflecht	Properties:	Excellent shield contact through the contact sleeve with the braided shield terminating in the screwed cable gland
Einsatztemperatur:	-40 °C / +100 °C	Operation temperature:	-40 °C / +100 °C



Progress MS Kombi EMC

UK  
CA

Einteiliger Dichteinsatz  
Nicht durchgehend isolierend

One-piece sealing insert  
not overall length insulated

G	AD mm	> Ø < min mm	> Ø < max mm	mm	H mm	L mm	Art.-No.	
Pg 7	10	4.5	6.0	15/17	35	10	1710.80.07.060.1	25
Pg 9	14	6.0	8.0	18/21	40	10	1710.80.09.080.1	25
Pg 9	14	8.0	10.0	18/21	40	10	1710.80.09.100.1	25
Pg 11	17	8.5	12.0	21/25	41	10	1710.80.11.120.1	25
Pg 11	17	5.5	8.5	21/25	41	10	1710.80.11.085.1	25
Pg 13	19	8.0	11.0	24/27	42	10	1710.80.13.110.1	25
Pg 13	19	11.0	14.0	24/27	42	10	1710.80.13.140.1	25
Pg 16	21	8.0	11.0	24/29	43	10	1710.80.16.110.1	25
Pg 16	21	11.0	14.0	24/29	43	10	1710.80.16.140.1	25
Pg 21	27	13.0	16.0	30/36	55	12	1710.80.21.160.1	10
Pg 21	27	16.0	19.0	30/36	55	12	1710.80.21.190.1	10
Pg 29	36	19.0	23.0	38/45	57	12	1710.80.29.230.1	10
Pg 29	36	23.0	25.5	38/45	57	12	1710.80.29.255.1	10
Pg 36	45	25.0	30.5	50/54	62	15	1710.80.36.305.1	5
Pg 36	45	30.5	35.0	50/54	62	15	1710.80.36.350.1	5
Pg 42	45	33.0	37.0	55/54	62	15	1710.80.42.370.1	5
Pg 42	45	37.0	41.0	55/54	62	15	1710.80.42.410.1	5
Pg 48	56	39.0	43.0	65/66	69	15	1710.80.48.430.1	5
Pg 48	56	43.0	46.5	65/66	69	15	1710.80.48.465.1	5

Je nach Schlauchtyp muss die passende Stabilisierungshülse separat bestellt werden.

Depending on the type of conduit, the stabilising bush must be ordered separately.

Erhältlich mit Dichteinsatz gemäss EN 45545 / NFPA 130. Bei Anfragen oder Bestellung bitte ein F vor die Artikelnummer setzen.

Available with sealing inserts conformity with EN 45545 / NFPA 130. When placing an inquiry, prefix the article number by the capital F.

# AGRO Adapter Progress® Messing mit integrierter EMV-Kabelverschraubung

## AGRO Adapters Progress® nickel-plated brass with integrated EMC cable gland

### Langes Anschlussgewinde metrisch | Long entry thread metric

Material:	Messing vernickelt	Material:	Nickel-plated brass
Kontakthülse:	Messing vernickelt	Contact sleeve:	Nickel-plated brass
Dichtung:	TPE	Seal:	TPE
O-Ring:	NBR	O-ring:	NBR
Zugentlastung:	Ausführung A nach EN 62444	Strain relief:	Version A acc. to EN 62444
Schutzart:	Kabelverschraubung IP 68	Protection class:	Cable gland IP 68
Hinweis:	Der max. Klemmbereich ist abhängig vom Schlauch-Innendurchmesser	Note:	The max. clamping range depends on the conduit inner diameter
Eigenschaften:	Sehr guter Schirmkontakt über die Kontakthülse bei in der Kabelverschraubung endendem Schirmgeflecht	Properties:	Excellent shield contact through the contact sleeve with the braided shield terminating in the screwed cable gland
Einsatztemperatur:	-40 °C / +100 °C	Operation temperature:	-40 °C / +100 °C



Einteiliger Dichteinsatz Nicht durchgehend isolierend		One-piece sealing insert not overall length insulated							
G	I	>math>10</math> min mm	>math>10</math> max mm	H mm	L mm	i info	Art.-No.		
M10x1.5	M10x1.5	3.0	4.0	13	32	10	1	1165.80.10.040	50
M10x1.5	M10x1.5	4.0	6.0	13	32	10	1	1165.80.10.060	50
M12x1.5	M12x1.5	4.5	6.0	15	34	10	-	1165.80.12.060	50
M12x1.5	M12x1.5	6.0	7.5	15	34	10	-	1165.80.12.075	50
M16x1.5	M16x1.5	6.0	8.0	18	38	10	-	1165.80.17.080	50
M16x1.5	M16x1.5	8.0	10.0	18	38	10	-	1165.80.17.100	50
M20x1.5	M20x1.5	8.0	11.0	24	40	10	-	1165.80.20.110	25
M20x1.5	M20x1.5	11.0	14.0	24	40	10	-	1165.80.20.140	25
M25x1.5	M25x1.5	13.0	16.0	30	46	11	-	1165.80.25.160	25
M25x1.5	M25x1.5	16.0	19.0	30	46	11	-	1165.80.25.190	25
M32x1.5	M32x1.5	18.0	21.0	36	49	13	-	1165.80.32.210	10
M32x1.5	M32x1.5	21.0	25.0	36	49	13	-	1165.80.32.250	10
M40x1.5	M40x1.5	24.0	28.5	46	51	13	-	1165.80.40.285	10
M40x1.5	M40x1.5	28.5	32.0	46	51	13	-	1165.80.40.320	5
M50x1.5	M50x1.5	33.0	37.0	55	55	14	-	1165.80.50.370	5
M50x1.5	M50x1.5	37.0	41.0	55	55	14	-	1165.80.50.410	5
M63x1.5	M63x1.5	40.0	46.0	70	59	14	-	1165.80.63.460	5
M63x1.5	M63x1.5	46.0	50.0	70	59	14	-	1165.80.63.500	5

1 = Metrisches Regelgewinde (mit VDE Testreport)      1 = Metric coarse-pitch thread (with VDE test report)

Erhältlich mit Dichteinsatz gemäss EN 45545 / NFPA 130. Bei Anfragen oder Bestellung bitte ein F vor die Artikelnummer setzen.

Available with sealing inserts conformity with EN 45545 / NFPA 130. When placing an inquiry, prefix the article number by the capital F.



Progress MS Kombi EMC



# AGRO Adapter Progress® Messing mit integrierter EMV-Kabelverschraubung

## AGRO Adapters Progress® nickel-plated brass with integrated EMC cable gland

### Langes Anschlussgewinde Pg | Long entry thread Pg

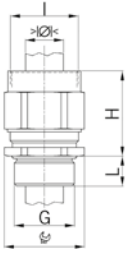

Material: Messing vernickelt  
 Kontakthülse: Messing vernickelt  
 Dichtung: TPE  
 O-Ring: NBR  
 Schutzart: Kabelverschraubung IP 68  
 Hinweis: Der max. Klemmbereich ist abhängig vom Schlauch-Innendurchmesser  
 Eigenschaften: Sehr guter Schirmkontakt über die Kontakthülse bei in der Kabelverschraubung endendem Schirmgeflecht

Material: Nickel-plated brass  
 Contact sleeve: Nickel-plated brass  
 Seal: TPE  
 O-ring: NBR  
 Protection class: Cable gland IP 68  
 Note: The max. clamping range depends on the conduit inner diameter  
 Properties: Excellent shield contact through the contact sleeve with the braided shield terminating in the screwed cable gland  
 Operation temperature: -40 °C / +100 °C

Einsatztemperatur: -40 °C / +100 °C

Operation temperature: -40 °C / +100 °C



Progress  
MS Kombi EMC



Einteiliger Dichteinsatz  
Nicht durchgehend isolierend

One-piece sealing insert  
not overall length insulated

G	I	> Ø < min mm	> Ø < max mm	mm	H mm	L mm	Art.-No.	
Pg 7	Pg 7	4.0	6.0	15	31	10	1165.80.07.060	50
Pg 7	Pg 7	6.0	7.5	15	31	10	1165.80.07.075	50
Pg 9	Pg 9	6.0	8.0	18	38	10	1165.80.09.080	50
Pg 9	Pg 9	8.0	10.0	18	38	10	1165.80.09.100	50
Pg 11	Pg 11	5.5	8.5	21	38	10	1165.80.11.085	50
Pg 11	Pg 11	8.5	12.0	21	38	10	1165.80.11.120	50
Pg 13	Pg 13	8.0	11.0	24	40	10	1165.80.13.110	25
Pg 13	Pg 13	11.0	14.0	24	40	10	1165.80.13.140	25
Pg 16	Pg 16	8.0	11.0	24	41	10	1165.80.16.110	25
Pg 16	Pg 16	11.0	14.0	24	41	10	1165.80.16.140	25
Pg 21	Pg 21	13.0	16.0	30	47	12	1165.80.21.160	10
Pg 21	Pg 21	16.0	19.0	30	47	12	1165.80.21.190	10
Pg 29	Pg 29	19.0	23.0	38/40	48	12	1165.80.29.230	10
Pg 29	Pg 29	23.0	25.5	38/40	48	12	1165.80.29.255	10
Pg 36	Pg 36	25.0	30.5	50	54	15	1165.80.36.305	10
Pg 36	Pg 36	30.5	35.0	50	54	15	1165.80.36.350	10
Pg 48	Pg 48	39.0	43.0	65	59	15	1165.80.48.430	5
Pg 48	Pg 48	43.0	46.5	65	59	15	1165.80.48.465	5

Erhältlich mit Dichteinsatz gemäss EN 45545 / NFPA 130. Bei Anfragen oder Bestellung bitte ein F vor die Artikelnummer setzen.

Available with sealing inserts conformity with EN 45545 / NFPA 130. When placing an inquiry, prefix the article number by the capital F.

# AGRO Kombi-EMV-Schlauchverschraubung für Kupfer-Hohlgeflechte

## AGRO combination EMC conduit gland for copper braidings

### Anschlussgewinde metrisch | Entry thread metric

Material: Messing vernickelt  
 Kontakthülse: Messing vernickelt  
 O-Ring: NBR  
 Schutzart: IP 68 (mit Rohrflex®-Ringwellschlauch)  
 Eigenschaften: Dank unserer Kombi-EMV-Schlauchverschraubung für Kupfer-Hohlgeflechte können die Geflechte problemlos auf Masse geführt werden. Eine Kontakthülse garantiert optimale und ausreissfeste Schirmkontaktierung und gleichzeitig eine vibrationsichere Einführung.

Material: Nickel-plated brass  
 Contact sleeve: Nickel-plated brass  
 O-ring: NBR  
 Protection class: IP 68 (together with Rohrflex® corrugated tube)  
 Properties: Copper braidings may be terminated without any problem with our combination EMC conduit gland. A contact bushing grants optimal shield contact at the same time vibration-proof leading of cables.

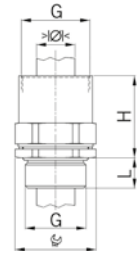

Einsatztemperatur: -40 °C / +120 °C

Operation temperature: -40 °C / +120 °C

Passend zu ROHRflex® Wellschlauch

Suitable for ROHRflex® corrugated tubings

G	$\varnothing$		$\frac{H}{2}$	H	L	Art.-No.	
	min mm	max mm					
M20x1.5	2.5	10.0	24	34.5	10	1165.84.20.15	25
M25x1.5	5.0	16.0	30	35.5	11	1165.84.25.21	25
M32x1.5	12.0	20.0	36	36.5	13	1165.84.32.34	25
M40x1.5	16.0	27.0	46	45	13	1165.84.40.34	10
M50x1.5	20.0	35.0	55	46	14	1165.84.50.42	5
M63x1.5	25.0	45.0	70	49	14	1165.84.63.54	5



1  
2  
3  
4  
5  
6  
7  
8  
9  
10  
11  
12  
13  
14  
15

# Druckring zu Schlauchverschraubungen

## Thrust collar for conduit glands

### Druckring Messing zu Schlauchverschraubungen | Thrust collar brass for conduit glands

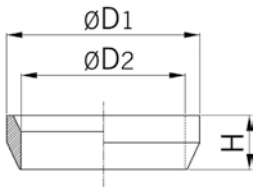

Material: Messing vernickelt  
 Einsatzbereich: Zur Erdung sowie als Potenzialausgleich bei Verwendung von Schläuchen mit Metallgeflecht im EMV-Einsatz  
 Einsatztemperatur: -40 °C / +250 °C

Material: Nickel-plated brass  
 Application: For grounding as well as potential equalization by use of conduits with metal braiding for shielding applications  
 Operation temperature: -40 °C / +250 °C



Zubehör zu Schlauchverschraubungen  
 Messing-Druckring

Conduit glands accessories  
 Thrust collar brass

AD mm	ØD1 mm	ØD2 mm	H mm	Art.-No.	
10	13	10.2	5.0	5031.034.007	50
14	17	14.5	5.0	5031.034.009	50
17	21	17.2	5.0	5031.034.011	50
19	23	19.2	6.0	5031.034.013	50
21	25	21.3	6.0	5031.034.016	50
27	32	27.3	8.5	5031.034.021	25
36	41	36.3	8.5	5031.034.029	25
45	50	45.3	8.5	5031.034.036	20
56	61	56.3	8.5	5031.034.048	10

Für EMV-Anwendungen Messingdruckring erforderlich! For EMC applications brass thrust collar necessary!

### Dichtring Kunststoff zu Schlauchverschraubungen | Synthetic thrust collar for conduit glands

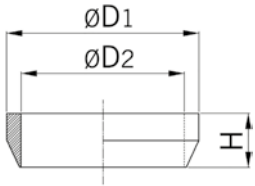

Material: PTFE (Teflon)  
 Einsatzbereich: Bei Verwendung von Schutzschläuchen mit Verschraubungen, geeignet für hohe Temperaturen  
 Einsatztemperatur: -60 °C / +300 °C

Material: PTFE (teflon)  
 Application: By using tubes with conduit glands suitable for high temperatures  
 Operation temperature: -60 °C / +300 °C



Zubehör zu Schlauchverschraubungen  
 Dichtring

Conduit glands accessories  
 Sealing ring

AD mm	ØD1 mm	ØD2 mm	H mm	Art.-No.	
10	13	10.3	6.0	5030.013.010	50
14	17	14.3	6.0	5030.013.014	50
17	21	17.3	6.0	5030.013.017	50
21	25	21.3	7.0	5030.013.021	50
27	32	27.4	9.5	5030.013.027	25
36	41	36.4	9.5	5030.013.036	25
45	50	45.4	9.5	5030.013.045	20
56	61	56.5	9.5	5030.013.056	10

Für hohe Temperaturen

For high temperature applications



Kabelverschraubungen Progress® multiLAYER Kunststoff GFK  
Synthetic cable glands Progress® multiLAYER GFK



224 - 226

Kabelverschraubungen Progress® Kunststoff GFK für mehrere Kabel  
Synthetic cable glands Progress® GFK for installation of multiple cables



227

Kabelverschraubungen Progress® Kunststoff GFK  
Synthetic cable glands Progress® GFK



228 - 234

1

2

3

4

5

6

7

8

9

10

11

12

13

14

15



# Kabelverschraubung Progress® Kunststoff

## Progress® synthetic cable gland

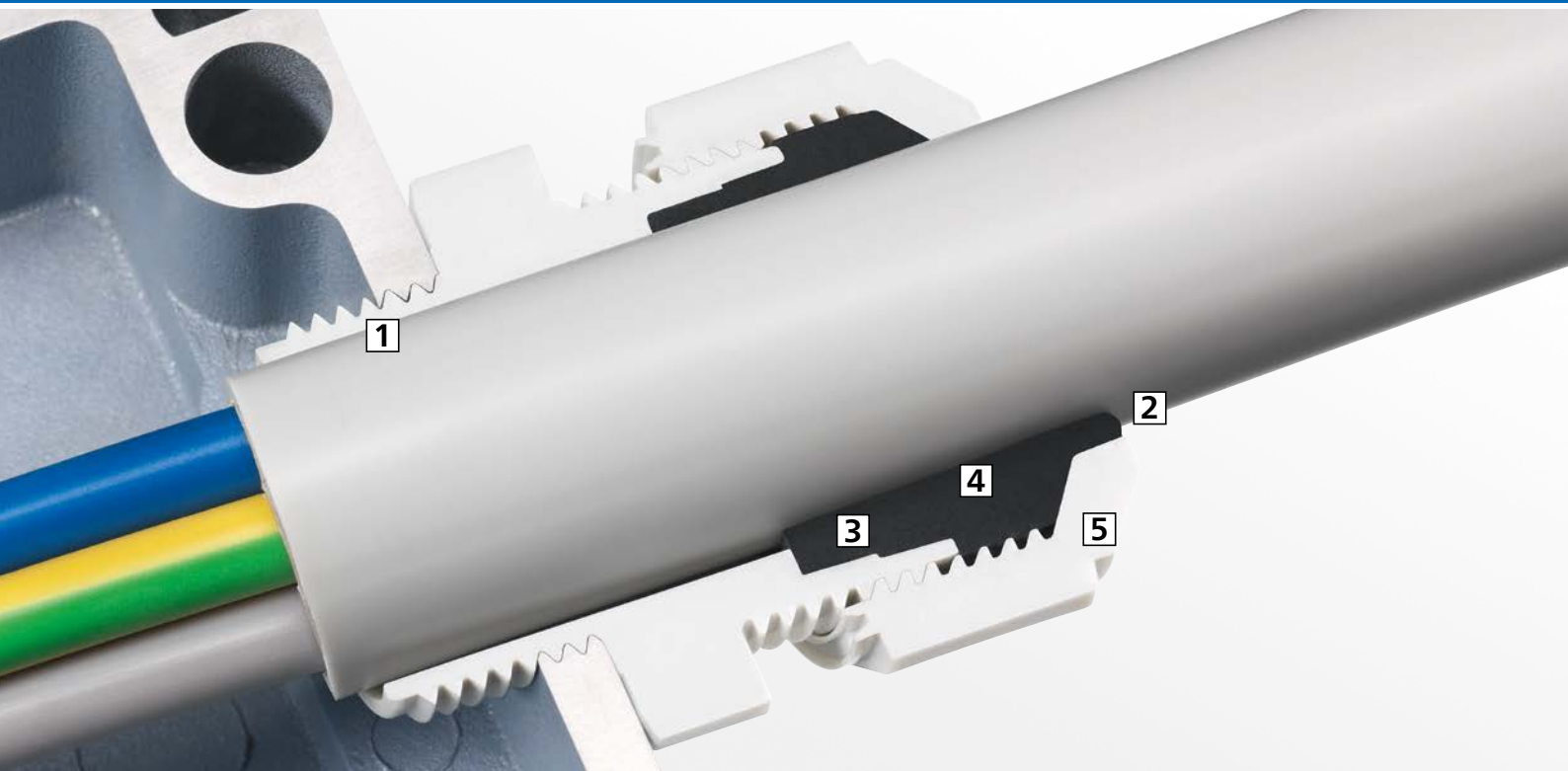

**Kabelverschraubungen Progress®** aus Kunststoff sind bewährte Helfer für die fachgerechte Kabeleinführung in Industrieanlagen. Die herausragende Kompressionstechnik sorgt für eine hohe Dichtigkeit und eine äusserst kabelschonende Zugentlastung.

### 1 Kurzes oder langes Anschlussgewinde

Kabelverschraubungen Progress® aus Kunststoff in metrischer oder Pg- Ausführung können bei vorhandenem Öffnungsgewinde oder mit Gegenmutter verwendet werden.

### 2 Sichtbare Sicherheit

Der kleine Wulst des Dichteinsatzes bestätigt das richtige Anzugsmoment.

### 3 Hoher Verdrehschutz

Der mit Halterippen ausgestattete Dichteinsatz sorgt für einen hohen Verdrehschutz.

### 4 Grosse Flexibilität

Zweiteilige Dichteinsätze können in Sekundenschnelle vor Ort auf den vorhandenen Kabeldurchmesser angepasst werden.

### 5 Garantierte Dichtigkeit

Auf den Dichteinsatz abgestimmte Innenkonturen sorgen für eine zielgerichtete Verformung des Dichteinsatzes und garantieren somit dessen perfekte Abdichtung.

**Progress® synthetic cable glands** are tried and tested aids for high-quality cable entries in industrial equipment. The outstanding compression technology ensures an effective seal and excellent cable-protecting strain relief.

### 1 Short or long connection thread

Progress® synthetic cable glands with metric or Pg designs can be used with existing hole threads or with a counter nut.

### 2 Visible reliability

A slight bulging of the sealing insert confirms the correct tightening torque.

### 3 Good anti-rotation protection

The sealing insert with its retaining ribs provides good anti-rotation protection.

### 4 Great flexibility

It only takes a few seconds to adapt the two-part sealing insert on site to the existing cable diameter.

### 5 Reliable leak-tightness

Inner contours matched to the sealing inserts insert ensure a targeted deformation of the insert and thus ensure its leak-tightness.

## Dichteinsätze

### Sealing inserts



**Einteiliger Dichteinsatz**  
One-piece sealing insert



**Zweiteiliger Dichteinsatz**  
Two-piece sealing insert



**multiLAYER Dichteinsatz**  
multiLAYER sealing insert

Progress® Kunststoff  
Progress® Synthetic

Standard  
Standard

Für mehrere Kabel  
For multiple cables

multiLAYER  
multiLAYER

Ausführung / Design				
Kompressionstechnik Compression technology		•	•	•
<b>Gewinde / Thread</b>				
Anschlussgewinde metrisch Entry thread metric		•	•	•
Anschlussgewinde Pg Entry thread Pg		•	•	-
Langes Anschlussgewinde Long entry thread		-	-	-
<b>Dichteinsatz / Sealing insert</b>				
Für Rundkabel For round cables		•	•	•
Für mehrere Kabel (Multi-Dichteinsatz) For multiple cables (Multi sealing insert)		•	•	-
Einteiliger Dichteinsatz One-piece sealing insert		•	•	-
Zweiteiliger Dichteinsatz Two-piece sealing insert		•	-	-
multiLAYER Dichteinsatz multiLAYER sealing insert		-	-	•
<b>Technische Besonderheiten / Technical features</b>				
Vibrationsschutz Vibration resistance		•	•	•
<b>Farben / Colours</b>				
Hellgrau RAL 7035 Light grey RAL 7035		•	•	•
Dunkelgrau RAL 7001 Dark grey RAL 7001		•	•	-
Schwarz RAL 9005 Black RAL 9005		•	•	•
Weiss RAL 9010 White RAL 9010		•	-	•
Graugrün RAL 7009 Greygreen RAL 7009		•	-	-

1

2

3

4

5

6

7

8

9

10

11

12

13

14

15

### Anschlussgewinde metrisch | Entry thread metric

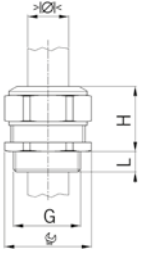

Material: Polyamid  
glasfaserverstärkt

Eigenschaften: halogenfrei

Dichtung: TPE

Zugentlastung: Ausführung A nach  
EN 62444

Schutzart: IP 68

Einsatztemperatur: -20 °C / +100 °C

Material: Polyamide  
glass fiber reinforced

Properties: halogen-free

Seal: TPE

Strain relief: Version A acc. to  
EN 62444

Protection class: IP 68

Operation temperature: -20 °C / +100 °C



Hellgrau RAL 7035  
Mehrteiliger Dichteinsatz

Light grey RAL 7035  
Multi-piece sealing insert

G	$\begin{matrix} > \ominus < \\ \text{min mm} \end{matrix}$	$\begin{matrix} > \ominus < \\ \text{max mm} \end{matrix}$	$\begin{matrix} \text{H} \\ \text{mm} \end{matrix}$	$\begin{matrix} \text{L} \\ \text{mm} \end{matrix}$	Art.-No.	
<b>M20x1.5</b>	4.0	15.0	27	28	1571.4.20	50
<b>M25x1.5</b>	6.0	20.5	34	33	1571.4.25	25
<b>M32x1.5</b>	10.0	25.5	41	35	1571.4.32	25



Schwarz RAL 9005  
Mehrteiliger Dichteinsatz

Black RAL 9005  
Multi-piece sealing insert

G	$\begin{matrix} > \ominus < \\ \text{min mm} \end{matrix}$	$\begin{matrix} > \ominus < \\ \text{max mm} \end{matrix}$	$\begin{matrix} \text{H} \\ \text{mm} \end{matrix}$	$\begin{matrix} \text{L} \\ \text{mm} \end{matrix}$	Art.-No.	
<b>M20x1.5</b>	4.0	15.0	27	28	1540.4.20	50
<b>M25x1.5</b>	6.0	20.5	34	33	1540.4.25	25
<b>M32x1.5</b>	10.0	25.5	41	35	1540.4.32	25



Weiss RAL 9010  
Mehrteiliger Dichteinsatz

White RAL 9010  
Multi-piece sealing insert

G	$\begin{matrix} > \ominus < \\ \text{min mm} \end{matrix}$	$\begin{matrix} > \ominus < \\ \text{max mm} \end{matrix}$	$\begin{matrix} \text{H} \\ \text{mm} \end{matrix}$	$\begin{matrix} \text{L} \\ \text{mm} \end{matrix}$	Art.-No.	
<b>M20x1.5</b>	4.0	15.0	27	28	1520.4.20	50
<b>M25x1.5</b>	6.0	20.5	34	33	1520.4.25	25

### Anschlussgewinde metrisch | Entry thread metric

Material: Polyamid  
glasfaserverstärkt

Eigenschaften: halogenfrei

Dichtung: TPE

Zugentlastung: Ausführung A nach  
EN 62444

Schutzart: IP 68

Einsatztemperatur: -20 °C / +100 °C

Material: Polyamide  
glass fiber reinforced

Properties: halogen-free

Seal: TPE

Strain relief: Version A acc. to  
EN 62444

Protection class: IP 68

Operation temperature: -20 °C / +100 °C

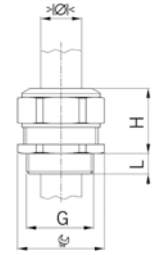

Hellgrau RAL 7035  
Einteiliger Dichteinsatz

Light grey RAL 7035  
One-piece sealing insert

G	$\begin{matrix} > \text{Ø} < \\ \text{min mm} \end{matrix}$	$\begin{matrix} > \text{Ø} < \\ \text{max mm} \end{matrix}$	$\begin{matrix} \text{Ø} \\ \text{mm} \end{matrix}$	H	L	Art.-No.	
	min mm	max mm	mm	mm	mm		
M8x1.0	2.5	3.5	12	15.5	10	1571.08.035	50
M8x1.0	3.5	5.0	12	15.5	10	1571.08.050	50
M10x1.0	3.0	4.0	15	18.0	10	1571.10.040	50
M10x1.0	4.0	6.0	15	18.0	10	1571.10.060	50
M12x1.5	3.5	5.0	17	22.0	12	1571.12.050	50
M12x1.5	5.0	6.5	17	22.0	12	1571.12.065	50
M12x1.5	6.5	8.0	17	22.0	12	1571.12.080	50
M16x1.5	4.5	6.0	21	26.0	12	1571.17.060	50
M16x1.5	6.0	8.0	21	26.0	12	1571.17.080	50
M16x1.5	8.0	10.5	21	26.0	12	1571.17.105	50
M20x1.5	6.0	8.0	27	28.0	13	1571.20.080	50
M20x1.5	8.0	11.0	27	28.0	13	1571.20.110	50
M20x1.5	11.0	15.0	27	28.0	13	1571.20.150	50
M25x1.5	9.5	12.5	34	33.0	13	1571.25.125	25
M25x1.5	12.5	16.0	34	33.0	13	1571.25.160	25
M25x1.5	16.0	20.5	34	33.0	13	1571.25.205	25
M32x1.5	14.0	17.0	41	35.0	15	1571.32.170	25
M32x1.5	17.0	21.0	41	35.0	15	1571.32.210	25
M32x1.5	21.0	25.5	41	35.0	15	1571.32.255	25
M40x1.5	20.0	24.0	50	40.0	15	1571.40.240	10
M40x1.5	24.0	28.5	50	40.0	15	1571.40.285	10
M40x1.5	28.5	33.0	50	40.0	15	1571.40.330	10
M50x1.5	29.0	33.0	60	42.0	16	1571.50.330	10
M50x1.5	33.0	37.0	60	42.0	16	1571.50.370	10
M50x1.5	37.0	42.0	60	42.0	16	1571.50.420	10
M63x1.5	35.0	40.0	75	48.0	16	1571.63.400	5
M63x1.5	40.0	46.0	75	48.0	16	1571.63.460	5
M63x1.5	46.0	52.0	75	48.0	16	1571.63.520	5



Progress GFK



Hellgrau RAL 7035  
Zweiteiliger Dichteinsatz

Light grey RAL 7035  
Two-piece sealing insert

G	$\begin{matrix} > \text{Ø} < \\ \text{min mm} \end{matrix}$	$\begin{matrix} > \text{Ø} < \\ \text{max mm} \end{matrix}$	$\begin{matrix} > \text{Ø} < \\ \text{min mm} \end{matrix}$	$\begin{matrix} > \text{Ø} < \\ \text{max mm} \end{matrix}$	$\begin{matrix} \text{Ø} \\ \text{mm} \end{matrix}$	H	L	Art.-No.	
	min mm	max mm	min mm	max mm	mm	mm	mm		
M16x1.5	6.0	8.0	8.0	10.5	21	26.0	12	1571.17	50
M20x1.5	8.0	11.0	11.0	15.0	27	28.0	13	1571.20	50
M25x1.5	12.5	16.0	16.0	20.5	34	33.0	13	1571.25	25
M32x1.5	17.0	21.0	21.0	25.5	41	35.0	15	1571.32	25
M40x1.5	24.0	28.5	28.5	33.0	50	40.0	15	1571.40	10
M50x1.5	33.0	37.0	37.0	42.0	60	42.0	16	1571.50	10
M63x1.5	40.0	46.0	46.0	52.0	75	48.0	16	1571.63	5

### Anschlussgewinde metrisch | Entry thread metric

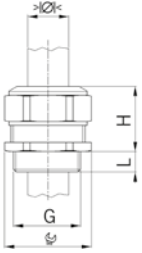

Material: Polyamid  
glasfaserverstärkt

Eigenschaften: halogenfrei

Dichtung: TPE

Schutzart: IP 54

Einsatztemperatur: -20 °C / +100 °C

Material: Polyamide  
glass fiber reinforced

Properties: halogen-free

Seal: TPE

Protection class: IP 54

Operation temperature: -20 °C / +100 °C



Hellgrau RAL 7035  
Einteiliger Dichteinsatz geschlitzt

Light grey RAL 7035  
One-piece sealing insert, slotted

G	>Ø<		Ø	PL	H	L	Art.-No.	
	min mm	max mm						
M20x1.5	3.0	4.5	15	27	28.0	13	<b>1571.20.045G</b>	50
M20x1.5	4.5	6.5	15	27	28.0	13	<b>1571.20.065G</b>	50
M20x1.5	6.0	8.0	15	27	28.0	13	<b>1571.20.080G</b>	50
M25x1.5	3.0	4.5	17	34	33.0	13	<b>1571.25.045G</b>	25
M25x1.5	4.5	6.5	17	34	33.0	13	<b>1571.25.065G</b>	25
M25x1.5	6.0	8.0	17	34	33.0	13	<b>1571.25.080G</b>	25
M32x1.5	3.0	4.5	25	41	35.0	15	<b>1571.32.045G</b>	25
M32x1.5	4.5	6.5	25	41	35.0	15	<b>1571.32.065G</b>	25
M32x1.5	6.0	8.0	25	41	35.0	15	<b>1571.32.080G</b>	25
M40x1.5	4.5	6.5	28	50	40.0	15	<b>1571.40.065G</b>	10
M40x1.5	6.0	8.0	28	50	40.0	15	<b>1571.40.080G</b>	10

# Kabelverschraubungen Progress® Kunststoff GFK für mehrere Kabel Synthetic cable glands Progress® GFK for installation of multiple cables

## Anschlussgewinde metrisch | Entry thread metric

Material: Polyamid  
glasfaserverstärkt  
Eigenschaften: halogenfrei  
Dichtung: TPE  
Zugentlastung: Ausführung A nach  
EN 62444  
Schutzart: IP 68  
Einsatztemperatur: -20 °C / +100 °C

Material: Polyamide  
glass fiber reinforced  
Properties: halogen-free  
Seal: TPE  
Strain relief: Version A acc. to  
EN 62444  
Protection class: IP 68  
Operation temperature: -20 °C / +100 °C

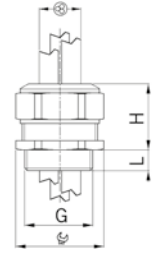

Hellgrau RAL 7035  
Einteiliger Dichteinsatz

Light grey RAL 7035  
One-piece sealing insert

G	$\varnothing$				H	L	Art.-No.	
	min mm	max mm						
M16x1.5	2.0	3.0	2	21	26	12	1571.17.2.030	50
M16x1.5	2.5	4.0	2	21	26	12	1571.17.2.040	50
M16x1.5	3.5	5.0	2	21	26	12	1571.17.2.050	50
M20x1.5	3.5	5.0	2	27	28	13	1571.20.2.050	50
M20x1.5	4.5	6.0	2	27	28	13	1571.20.2.060	50
M20x1.5	5.5	7.5	2	27	28	13	1571.20.2.075	50
M20x1.5	3.5	5.0	3	27	28	13	1571.20.3.050	50
M20x1.5	4.5	6.0	3	27	28	13	1571.20.3.060	50
M20x1.5	5.2	6.5	3	27	28	13	1571.20.3.065	50
M20x1.5	3.5	5.0	4	27	28	13	1571.20.4.050	50
M20x1.5	4.5	6.0	4	27	28	13	1571.20.4.060	50
M25x1.5	5.0	7.0	2	34	33	13	1571.25.2.070	25
M25x1.5	6.7	9.0	2	34	33	13	1571.25.2.090	25
M25x1.5	7.7	10.0	2	34	33	13	1571.25.2.100	25
M25x1.5	5.5	7.0	3	34	33	13	1571.25.3.070	25
M25x1.5	6.8	9.0	3	34	33	13	1571.25.3.090	25
M25x1.5	5.5	7.0	4	34	33	13	1571.25.4.070	25
M25x1.5	4.8	6.0	6	34	33	13	1571.25.6.060	25
M32x1.5	9.0	11.5	2	41	35	15	1571.32.2.115	25
M32x1.5	7.0	9.0	3	41	35	15	1571.32.3.090	25
M32x1.5	8.5	10.5	3	41	35	15	1571.32.3.105	25
M32x1.5	7.0	9.0	4	41	35	15	1571.32.4.090	25
M32x1.5	5.8	7.0	6	41	35	15	1571.32.6.070	25

Weitere Ausführungen und Farben auf Anfrage: z.B. dunkelgrau RAL 7001, schwarz RAL 9005, grössere Anschlussgewinde

Additional versions and colours are available upon request: e.g. dark grey RAL 7001, black RAL 9005, larger entry threads



Progress GFK Multi



# Kabelverschraubungen Progress® Kunststoff GFK

## Synthetic cable glands Progress® GFK

### Anschlussgewinde metrisch | Entry thread metric

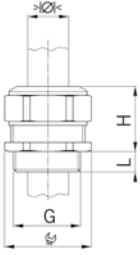

Material: Agromid glasfaserverstärkt, wärmealterungs- und schlagzäh modifiziert

Eigenschaften: halogenfrei

Dichtung: TPE

Zugentlastung: Ausführung A nach EN 62444

Schutzart: IP 68

Einsatztemperatur: -30 °C / +100 °C

Material: Agromid glass fiber reinforced, heat aging and impact-resistant modified

Properties: halogen-free

Seal: TPE

Strain relief: Version A acc. to EN 62444

Protection class: IP 68

Operation temperature: -30 °C / +100 °C



Progress GFK



Dunkelgrau RAL 7001  
Einteiliger Dichteinsatz

Dark grey RAL 7001  
One-piece sealing insert

G	> Ø <	> Ø <	Ø	H	L	Art.-No.	
	min mm	max mm	mm	mm	mm		
M8x1.0	2.5	3.5	12	15.5	10	1572.08.035	50
M8x1.0	3.5	5.0	12	15.5	10	1572.08.050	50
M10x1.0	3.0	4.0	15	18.0	10	1572.10.040	50
M10x1.0	4.0	6.0	15	18.0	10	1572.10.060	50
M12x1.5	3.5	5.0	17	22.0	12	1572.12.050	50
M12x1.5	5.0	6.5	17	22.0	12	1572.12.065	50
M12x1.5	6.5	8.0	17	22.0	12	1572.12.080	50
M16x1.5	4.5	6.0	21	26.0	12	1572.17.060	50
M16x1.5	6.0	8.0	21	26.0	12	1572.17.080	50
M16x1.5	8.0	10.5	21	26.0	12	1572.17.105	50
M20x1.5	6.0	8.0	27	28.0	13	1572.20.080	50
M20x1.5	8.0	11.0	27	28.0	13	1572.20.110	50
M20x1.5	11.0	15.0	27	28.0	13	1572.20.150	50
M25x1.5	9.5	12.5	34	33.0	13	1572.25.125	25
M25x1.5	12.5	16.0	34	33.0	13	1572.25.160	25
M25x1.5	16.0	20.5	34	33.0	13	1572.25.205	25
M32x1.5	14.0	17.0	41	35.0	15	1572.32.170	25
M32x1.5	17.0	21.0	41	35.0	15	1572.32.210	25
M32x1.5	21.0	25.5	41	35.0	15	1572.32.255	25
M40x1.5	20.0	24.0	50	40.0	15	1572.40.240	10
M40x1.5	24.0	28.5	50	40.0	15	1572.40.285	10
M40x1.5	28.5	33.0	50	40.0	15	1572.40.330	10
M50x1.5	29.0	33.0	60	42.0	16	1572.50.330	10
M50x1.5	33.0	37.0	60	42.0	16	1572.50.370	10
M50x1.5	37.0	42.0	60	42.0	16	1572.50.420	10
M63x1.5	35.0	40.0	75	48.0	16	1572.63.400	5
M63x1.5	40.0	46.0	75	48.0	16	1572.63.460	5
M63x1.5	46.0	52.0	75	48.0	16	1572.63.520	5

Dunkelgrau RAL 7001  
Zweiteiliger Dichteinsatz

Dark grey RAL 7001  
Two-piece sealing insert

G	> Ø <	> Ø <	> Ø <	> Ø <	Ø	H	L	Art.-No.	
	min mm	max mm	min mm	max mm	mm	mm	mm		
M16x1.5	6.0	8.0	8.0	10.5	21	26.0	12	1572.17	50
M20x1.5	8.0	11.0	11.0	15.0	27	28.0	13	1572.20	50
M25x1.5	12.5	16.0	16.0	20.5	34	33.0	13	1572.25	25
M32x1.5	17.0	21.0	21.0	25.5	41	35.0	15	1572.32	25
M40x1.5	24.0	28.5	28.5	33.0	50	40.0	15	1572.40	10
M50x1.5	33.0	37.0	37.0	42.0	60	42.0	16	1572.50	10
M63x1.5	40.0	46.0	46.0	52.0	75	48.0	16	1572.63	5

### Anschlussgewinde metrisch | Entry thread metric

Material: Polyamid  
glasfaserverstärkt

Eigenschaften: halogenfrei

Dichtung: TPE

Zugentlastung: Ausführung A nach  
EN 62444

Schutzart: IP 68

Einsatztemperatur: -20 °C / +100 °C

Material: Polyamide  
glass fiber reinforced

Properties: halogen-free

Seal: TPE

Strain relief: Version A acc. to  
EN 62444

Protection class: IP 68

Operation temperature: -20 °C / +100 °C

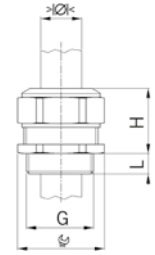

Schwarz RAL 9005  
Einteiliger Dichteinsatz

Black RAL 9005  
One-piece sealing insert

G	$\begin{matrix} > \text{Ø} < \\ \text{min mm} \end{matrix}$	$\begin{matrix} > \text{Ø} < \\ \text{max mm} \end{matrix}$	$\begin{matrix} \text{Ø} \\ \text{mm} \end{matrix}$	H	L	Art.-No.	
	min mm	max mm	mm	mm	mm		
M8x1.0	2.5	3.5	12	15.5	10	1540.08.035	50
M8x1.0	3.5	5.0	12	15.5	10	1540.08.050	50
M10x1.0	3.0	4.0	15	18.0	10	1540.10.040	50
M10x1.0	4.0	6.0	15	18.0	10	1540.10.060	50
M12x1.5	3.5	5.0	17	22.0	12	1540.12.050	50
M12x1.5	5.0	6.5	17	22.0	12	1540.12.065	50
M12x1.5	6.5	8.0	17	22.0	12	1540.12.080	50
M16x1.5	4.5	6.0	21	26.0	12	1540.17.060	50
M16x1.5	6.0	8.0	21	26.0	12	1540.17.080	50
M16x1.5	8.0	10.5	21	26.0	12	1540.17.105	50
M20x1.5	6.0	8.0	27	28.0	13	1540.20.080	50
M20x1.5	8.0	11.0	27	28.0	13	1540.20.110	50
M20x1.5	11.0	15.0	27	28.0	13	1540.20.150	50
M25x1.5	9.5	12.5	34	33.0	13	1540.25.125	25
M25x1.5	12.5	16.0	34	33.0	13	1540.25.160	25
M25x1.5	16.0	20.5	34	33.0	13	1540.25.205	25
M32x1.5	14.0	17.0	41	35.0	15	1540.32.170	25
M32x1.5	17.0	21.0	41	35.0	15	1540.32.210	25
M32x1.5	21.0	25.5	41	35.0	15	1540.32.255	25
M40x1.5	20.0	24.0	50	40.0	15	1540.40.240	10
M40x1.5	24.0	28.5	50	40.0	15	1540.40.285	10
M40x1.5	28.5	33.0	50	40.0	15	1540.40.330	10
M50x1.5	29.0	33.0	60	42.0	16	1540.50.330	10
M50x1.5	33.0	37.0	60	42.0	16	1540.50.370	10
M50x1.5	37.0	42.0	60	42.0	16	1540.50.420	10
M63x1.5	35.0	40.0	75	48.0	16	1540.63.400	5
M63x1.5	40.0	46.0	75	48.0	16	1540.63.460	5
M63x1.5	46.0	52.0	75	48.0	16	1540.63.520	5



Progress GFK



Schwarz RAL 9005  
Zweiteiliger Dichteinsatz

Black RAL 9005  
Two-piece sealing insert

G	$\begin{matrix} > \text{Ø} < \\ \text{min mm} \end{matrix}$	$\begin{matrix} > \text{Ø} < \\ \text{max mm} \end{matrix}$	$\begin{matrix} > \text{Ø} < \\ \text{min mm} \end{matrix}$	$\begin{matrix} > \text{Ø} < \\ \text{max mm} \end{matrix}$	$\begin{matrix} \text{Ø} \\ \text{mm} \end{matrix}$	H	L	Art.-No.	
	min mm	max mm	min mm	max mm	mm	mm	mm		
M16x1.5	6.0	8.0	8.0	10.5	21	26.0	12	1540.17	50
M20x1.5	8.0	11.0	11.0	15.0	27	28.0	13	1540.20	50
M25x1.5	12.5	16.0	16.0	20.5	34	33.0	13	1540.25	25
M32x1.5	17.0	21.0	21.0	25.5	41	35.0	15	1540.32	25
M40x1.5	24.0	28.5	28.5	33.0	50	40.0	15	1540.40	10
M50x1.5	33.0	37.0	37.0	42.0	60	42.0	16	1540.50	10
M63x1.5	40.0	46.0	46.0	52.0	75	48.0	16	1540.63	5

# Kabelverschraubungen Progress® Kunststoff GFK

## Synthetic cable glands Progress® GFK

### Anschlussgewinde metrisch | Entry thread metric

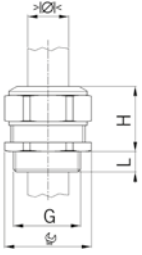

Material: Polyamid  
glasfaserverstärkt

Eigenschaften: halogenfrei

Dichtung: TPE

Zugentlastung: Ausführung A nach  
EN 62444

Schutzart: IP 68

Einsatztemperatur: -20 °C / +100 °C

Material: Polyamide  
glass fiber reinforced

Properties: halogen-free

Seal: TPE

Strain relief: Version A acc. to  
EN 62444

Protection class: IP 68

Operation temperature: -20 °C / +100 °C



Weiss RAL 9010  
Einteiliger Dichteinsatz

White RAL 9010  
One-piece sealing insert

G	$\begin{matrix} > \text{Ø} < \\ \text{min mm} \end{matrix}$	$\begin{matrix} > \text{Ø} < \\ \text{max mm} \end{matrix}$	$\begin{matrix} \text{Ø} \\ \text{mm} \end{matrix}$	H mm	L mm	Art.-No.	
M20x1.5	6.0	8.0	27	28	13	1520.20.080	50
M20x1.5	8.0	11.0	27	28	13	1520.20.110	50

Progress GFK



Weiss RAL 9010  
Zweiteiliger Dichteinsatz

White RAL 9010  
Two-piece sealing insert

G	$\begin{matrix} > \text{Ø} < \\ \text{min mm} \end{matrix}$	$\begin{matrix} > \text{Ø} < \\ \text{max mm} \end{matrix}$	$\begin{matrix} > \text{Ø} < \\ \text{min mm} \end{matrix}$	$\begin{matrix} > \text{Ø} < \\ \text{max mm} \end{matrix}$	$\begin{matrix} \text{Ø} \\ \text{mm} \end{matrix}$	H mm	L mm	Art.-No.	
M16x1.5	6.0	8.0	8.0	10.5	21	26	12	1520.17	50
M20x1.5	8.0	11.0	11.0	15.0	27	28	13	1520.20	50
M25x1.5	12.5	16.0	16.0	20.5	34	33	13	1520.25	25



Graugrün RAL 7009  
Zweiteiliger Dichteinsatz

Greygreen RAL 7009  
Two-piece sealing insert

G	$\begin{matrix} > \text{Ø} < \\ \text{min mm} \end{matrix}$	$\begin{matrix} > \text{Ø} < \\ \text{max mm} \end{matrix}$	$\begin{matrix} > \text{Ø} < \\ \text{min mm} \end{matrix}$	$\begin{matrix} > \text{Ø} < \\ \text{max mm} \end{matrix}$	$\begin{matrix} \text{Ø} \\ \text{mm} \end{matrix}$	H mm	L mm	Art.-No.	
M16x1.5	6.0	8.0	8.0	10.5	21	26	12	1570.17	50
M20x1.5	8.0	11.0	11.0	15.0	27	28	13	1570.20	50
M25x1.5	12.5	16.0	16.0	20.5	34	33	13	1570.25	25
M32x1.5	17.0	21.0	21.0	25.5	41	35	15	1570.32	25

Progress GFK



### Anschlussgewinde Pg | Entry thread Pg

Material: Polyamid  
glasfaserverstärkt

Eigenschaften: halogenfrei

Dichtung: TPE

Schutzart: IP 68

Einsatztemperatur: -20 °C / +100 °C

Material: Polyamide glass fiber  
reinforced

Properties: halogen-free

Seal: TPE

Protection class: IP 68

Operation temperature: -20 °C / +100 °C

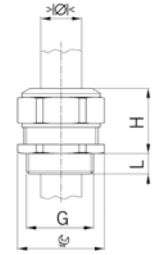

Hellgrau RAL 7035  
Einteiliger Dichteinsatz

Light grey RAL 7035  
One-piece sealing insert

G	$\begin{matrix} \text{>}\text{Ø}\text{<} \\ \text{min mm} \end{matrix}$	$\begin{matrix} \text{>}\text{Ø}\text{<} \\ \text{max mm} \end{matrix}$	$\begin{matrix} \text{Ø} \\ \text{mm} \end{matrix}$	H	L	Art.-No.	
	min mm	max mm	mm	mm	mm		
Pg 7	3.5	5.0	17	22	12	1571.07.050	50
Pg 7	5.0	6.5	17	22	12	1571.07.065	50
Pg 7	6.5	8.0	17	22	12	1571.07.080	50
Pg 9	4.5	6.0	21	26	12	1571.09.060	50
Pg 9	6.0	8.0	21	26	12	1571.09.080	50
Pg 9	8.0	10.5	21	26	12	1571.09.105	50
Pg 11	4.0	5.5	24	28	12	1571.11.055	50
Pg 11	5.5	8.5	24	28	12	1571.11.085	50
Pg 11	8.5	12.0	24	28	12	1571.11.120	50
Pg 13	6.0	8.0	27	28	13	1571.13.080	50
Pg 13	8.0	11.0	27	28	13	1571.13.110	50
Pg 13	11.0	15.0	27	28	13	1571.13.150	50
Pg 16	6.0	8.0	27	28	13	1571.16.080	50
Pg 16	8.0	11.0	27	28	13	1571.16.110	50
Pg 16	11.0	15.0	27	28	13	1571.16.150	50
Pg 21	9.5	12.5	34	33	13	1571.21.125	25
Pg 21	12.5	16.0	34	33	13	1571.21.160	25
Pg 21	16.0	20.5	34	33	13	1571.21.205	25
Pg 29	16.0	19.0	41	36	13	1571.29.190	25
Pg 29	19.0	23.0	41	36	13	1571.29.230	25
Pg 29	23.0	27.5	41	36	13	1571.29.275	25
Pg 36	21.5	26.0	55	42	16	1571.36.260	10
Pg 36	26.0	30.5	55	42	16	1571.36.305	10
Pg 36	30.5	35.0	55	42	16	1571.36.350	10
Pg 42	29.0	33.0	60	42	16	1571.42.330	10
Pg 42	33.0	37.0	60	42	16	1571.42.370	10
Pg 42	37.0	42.0	60	42	16	1571.42.420	10
Pg 48	32.0	37.0	70	46	16	1571.48.370	5
Pg 48	37.0	43.0	70	46	16	1571.48.430	5
Pg 48	43.0	49.0	70	46	16	1571.48.490	5

Hellgrau RAL 7035  
Zweiteiliger Dichteinsatz

Light grey RAL 7035  
Two-piece sealing insert

G	$\begin{matrix} \text{>}\text{Ø}\text{<} \\ \text{min mm} \end{matrix}$	$\begin{matrix} \text{>}\text{Ø}\text{<} \\ \text{max mm} \end{matrix}$	$\begin{matrix} \text{>}\text{Ø}\text{<} \\ \text{min mm} \end{matrix}$	$\begin{matrix} \text{>}\text{Ø}\text{<} \\ \text{max mm} \end{matrix}$	$\begin{matrix} \text{Ø} \\ \text{mm} \end{matrix}$	H	L	Art.-No.	
	min mm	max mm	min mm	max mm	mm	mm	mm		
Pg 9	6.0	8.0	8.0	10.5	21	26	12	1571.09	50
Pg 11	5.5	8.5	8.5	12.0	24	28	12	1571.11	50
Pg 13	8.0	11.0	11.0	15.0	27	28	13	1571.13	50
Pg 16	8.0	11.0	11.0	15.0	27	28	13	1571.16	50
Pg 21	12.5	16.0	16.0	20.5	34	33	13	1571.21	25
Pg 29	19.0	23.0	23.0	27.5	41	36	13	1571.29	25
Pg 36	26.0	30.5	30.5	35.0	55	42	16	1571.36	10
Pg 42	33.0	37.0	37.0	42.0	60	42	16	1571.42	10
Pg 48	37.0	43.0	43.0	49.0	70	46	16	1571.48	5

# Kabelverschraubungen Progress® Kunststoff GFK für mehrere Kabel Synthetic cable glands Progress® GFK for installation of multiple cables

## Anschlussgewinde Pg | Entry thread Pg

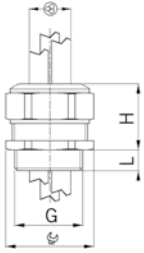

Material: Polyamid  
glasfaserverstärkt  
Eigenschaften: halogenfrei  
Dichtung: TPE  
Schutzart: IP 68  
Einsatztemperatur: -20 °C / +100 °C

Material: Polyamide  
glass fiber reinforced  
Properties: halogen-free  
Seal: TPE  
Protection class: IP 68  
Operation temperature: -20 °C / +100 °C



Hellgrau RAL 7035  
Einteiliger Dichteinsatz

Light grey RAL 7035  
One-piece sealing insert

G	$\begin{matrix} > \text{Ø} < \\ \text{min mm} \end{matrix}$	$\begin{matrix} > \text{Ø} < \\ \text{max mm} \end{matrix}$	$\begin{matrix} \text{⊗} \\ \text{mm} \end{matrix}$	$\begin{matrix} \text{H} \\ \text{mm} \end{matrix}$	$\begin{matrix} \text{L} \\ \text{mm} \end{matrix}$	Art.-No.	
Pg 9	2.0	3.0	2	21	26	1571.09.2.030	50
Pg 9	2.5	4.0	2	21	26	1571.09.2.040	50
Pg 9	3.5	5.0	2	21	26	1571.09.2.050	50
Pg 11	3.5	5.0	2	24	28	1571.11.2.050	50
Pg 11	4.5	6.0	2	24	28	1571.11.2.060	50
Pg 11	3.5	5.0	3	24	28	1571.11.3.050	50
Pg 13	3.5	5.0	2	27	28	1571.13.2.050	50
Pg 13	4.5	6.0	2	27	28	1571.13.2.060	50
Pg 13	5.5	7.5	2	27	28	1571.13.2.075	50
Pg 13	3.5	5.0	3	27	28	1571.13.3.050	50
Pg 13	4.5	6.0	3	27	28	1571.13.3.060	50
Pg 13	5.2	6.5	3	27	28	1571.13.3.065	50
Pg 13	3.5	5.0	4	27	28	1571.13.4.050	50
Pg 13	4.5	6.0	4	27	28	1571.13.4.060	50
Pg 16	3.5	5.0	2	27	28	1571.16.2.050	50
Pg 16	4.5	6.0	2	27	28	1571.16.2.060	50
Pg 16	5.5	7.5	2	27	28	1571.16.2.075	50
Pg 16	3.5	5.0	3	27	28	1571.16.3.050	50
Pg 16	4.5	6.0	3	27	28	1571.16.3.060	50
Pg 16	5.2	6.5	3	27	28	1571.16.3.065	50
Pg 16	3.5	5.0	4	27	28	1571.16.4.050	50
Pg 16	4.5	6.0	4	27	28	1571.16.4.060	50
Pg 21	5.0	7.0	2	34	33	1571.21.2.070	25
Pg 21	6.7	9.0	2	34	33	1571.21.2.090	25
Pg 21	7.7	10.0	2	34	33	1571.21.2.100	25
Pg 21	5.5	7.0	3	34	33	1571.21.3.070	25
Pg 21	6.8	9.0	3	34	33	1571.21.3.090	25
Pg 21	5.5	7.0	4	34	33	1571.21.4.070	25
Pg 21	4.8	6.0	6	34	33	1571.21.6.060	25
Pg 29	7.5	9.0	3	41	36	1571.29.3.090	25

Weitere Ausführungen und Farben auf Anfrage: z.B. dunkelgrau RAL 7001, schwarz RAL 9005, grössere

Additional versions and colours are available upon request: e.g. dark grey RAL 7001, black RAL 9005, larger entry threads

### Anschlussgewinde Pg | Entry thread Pg

Material: Agromid glasfaserverstärkt, wärmealterungs- und schlagzäh modifiziert

Eigenschaften: halogenfrei

Dichtung: TPE

Schutzart: IP 68

Einsatztemperatur: -30 °C / +100 °C

Material: Agromid glass fiber reinforced, heat aging and impact-resistant modified

Properties: halogen-free

Seal: TPE

Protection class: IP 68

Operation temperature: -30 °C / +100 °C

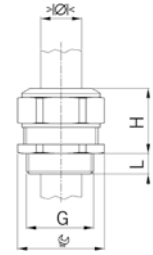

Dunkelgrau RAL 7001  
Einteiliger Dichteinsatz

Dark grey RAL 7001  
One-piece sealing insert

G	min mm	max mm	mm	H	L	Art.-No.	
Pg 7	3.5	5.0	17	22	12	1572.07.050	50
Pg 7	5.0	6.5	17	22	12	1572.07.065	50
Pg 7	6.5	8.0	17	22	12	1572.07.080	50
Pg 9	4.5	6.0	21	26	12	1572.09.060	50
Pg 9	6.0	8.0	21	26	12	1572.09.080	50
Pg 9	8.0	10.5	21	26	12	1572.09.105	50
Pg 11	4.0	5.5	24	28	12	1572.11.055	50
Pg 11	5.5	8.5	24	28	12	1572.11.085	50
Pg 11	8.5	12.0	24	28	12	1572.11.120	50
Pg 13	6.0	8.0	27	28	13	1572.13.080	50
Pg 13	8.0	11.0	27	28	13	1572.13.110	50
Pg 13	11.0	15.0	27	28	13	1572.13.150	50
Pg 16	6.0	8.0	27	28	13	1572.16.080	50
Pg 16	8.0	11.0	27	28	13	1572.16.110	50
Pg 16	11.0	15.0	27	28	13	1572.16.150	50
Pg 21	9.5	12.5	34	33	13	1572.21.125	25
Pg 21	12.5	16.0	34	33	13	1572.21.160	25
Pg 21	16.0	20.5	34	33	13	1572.21.205	25
Pg 29	16.0	19.0	41	36	13	1572.29.190	25
Pg 29	19.0	23.0	41	36	13	1572.29.230	25
Pg 29	23.0	27.5	41	36	13	1572.29.275	25
Pg 36	21.5	26.0	55	42	16	1572.36.260	10
Pg 36	26.0	30.5	55	42	16	1572.36.305	10
Pg 36	30.5	35.0	55	42	16	1572.36.350	10
Pg 42	29.0	33.0	60	42	16	1572.42.330	10
Pg 42	33.0	37.0	60	42	16	1572.42.370	10
Pg 42	37.0	42.0	60	42	16	1572.42.420	10
Pg 48	32.0	37.0	70	46	16	1572.48.370	5
Pg 48	37.0	43.0	70	46	16	1572.48.430	5
Pg 48	43.0	49.0	70	46	16	1572.48.490	5



Dunkelgrau RAL 7001  
Zweiteiliger Dichteinsatz

Dark grey RAL 7001  
Two-piece sealing insert

G	min mm	max mm	min mm	max mm	mm	H	L	Art.-No.	
Pg 9	6.0	8.0	8.0	10.5	21	26	12	1572.09	50
Pg 11	5.5	8.5	8.5	12.0	24	28	12	1572.11	50
Pg 13	8.0	11.0	11.0	15.0	27	28	13	1572.13	50
Pg 16	8.0	11.0	11.0	15.0	27	28	13	1572.16	50
Pg 21	12.5	16.0	16.0	20.5	34	33	13	1572.21	25
Pg 29	19.0	23.0	23.0	27.5	41	36	13	1572.29	25
Pg 36	26.0	30.5	30.5	35.0	55	42	16	1572.36	10
Pg 42	33.0	27.0	27.0	42.0	60	42	16	1572.42	10
Pg 48	37.0	43.0	43.0	49.0	70	46	16	1572.48	5

### Anschlussgewinde Pg | Entry thread Pg

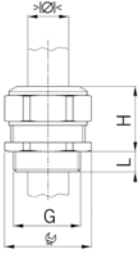

Material: Polyamid  
glasfaserverstärkt

Eigenschaften: halogenfrei

Dichtung: TPE

Schutzart: IP 68

Einsatztemperatur: -20 °C / +100 °C

Material: Polyamide  
glass fiber reinforced

Properties: halogen-free

Seal: TPE

Protection class: IP 68

Operation temperature: -20 °C / +100 °C



Schwarz RAL 9005  
Einteiliger Dichteinsatz

Black RAL 9005  
One-piece sealing insert

G	> Ø <	> Ø <	⊕	H	L	Art.-No.	
	min mm	max mm	mm	mm	mm		
Pg 7	3.5	5.0	17	22	12	1540.07.050	50
Pg 7	5.0	6.5	17	22	12	1540.07.065	50
Pg 7	6.5	8.0	17	22	12	1540.07.080	50
Pg 9	4.5	6.0	21	26	12	1540.09.060	50
Pg 9	6.0	8.0	21	26	12	1540.09.080	50
Pg 9	8.0	10.5	21	26	12	1540.09.105	50
Pg 11	4.0	5.5	24	28	12	1540.11.055	50
Pg 11	5.5	8.5	24	28	12	1540.11.085	50
Pg 11	8.5	12.0	24	28	12	1540.11.120	50
Pg 13	6.0	8.0	27	28	13	1540.13.080	50
Pg 13	8.0	11.0	27	28	13	1540.13.110	50
Pg 13	11.0	15.0	27	28	13	1540.13.150	50
Pg 16	6.0	8.0	27	28	13	1540.16.080	50
Pg 16	8.0	11.0	27	28	13	1540.16.110	50
Pg 16	11.0	15.0	27	28	13	1540.16.150	50
Pg 21	9.5	12.5	34	33	13	1540.21.125	25
Pg 21	12.5	16.0	34	33	13	1540.21.160	25
Pg 21	16.0	20.5	34	33	13	1540.21.205	25
Pg 29	16.0	19.0	41	36	13	1540.29.190	25
Pg 29	19.0	23.0	41	36	13	1540.29.230	25
Pg 29	23.0	27.5	41	36	13	1540.29.275	25
Pg 36	21.5	26.0	55	42	16	1540.36.260	10
Pg 36	26.0	30.5	55	42	16	1540.36.305	10
Pg 36	30.5	35.0	55	42	16	1540.36.350	10
Pg 42	29.0	33.0	60	42	16	1540.42.330	10
Pg 42	33.0	37.0	60	42	16	1540.42.370	10
Pg 42	37.0	42.0	60	42	16	1540.42.420	10
Pg 48	32.0	37.0	70	46	16	1540.48.370	5
Pg 48	37.0	43.0	70	46	16	1540.48.430	5
Pg 48	43.0	49.0	70	46	16	1540.48.490	5

Schwarz RAL 9005  
Zweiteiliger Dichteinsatz

Black RAL 9005  
Two-piece sealing insert

G	> Ø <	> Ø <	> Ø <	> Ø <	⊕	H	L	Art.-No.	
	min mm	max mm	min mm	max mm	mm	mm	mm		
Pg 9	6.0	8.0	8.0	10.5	21	26	12	1540.09	50
Pg 11	5.5	8.5	8.5	12.0	24	28	12	1540.11	50
Pg 13	8.0	11.0	11.0	15.0	27	28	13	1540.13	50
Pg 16	8.0	11.0	11.0	15.0	27	28	13	1540.16	50
Pg 21	12.5	16.0	16.0	20.5	34	33	13	1540.21	25
Pg 29	19.0	23.0	23.0	27.5	41	36	13	1540.29	25
Pg 36	26.0	30.5	30.5	35.0	55	42	16	1540.36	10
Pg 42	33.0	37.0	37.0	42.0	60	42	16	1540.42	10
Pg 48	37.0	43.0	43.0	49.0	70	46	16	1540.48	5



Kabelverschraubungen Syntec® Messing mit Lamellentechnik  
Cable glands Syntec® nickel-plated brass with lamellar technology



238

Kabelverschraubungen Syntec® Kunststoff mit Lamellentechnik  
Synthetic cable glands Syntec® with lamellar technology



239 - 242

Kabelverschraubungen Syntec® Kunststoff mit Lamellentechnik und Knickschutz  
Synthetic cable glands Syntec® with lamellar technology and anti-kink nozzle



243 - 246

1

2

3

4

5

6

7

8

9

10

11

12

13

14

15

# Kabelverschraubungen Syntec® Messing und Kunststoff

## Cable glands Syntec® nickel-plated brass and synthetic

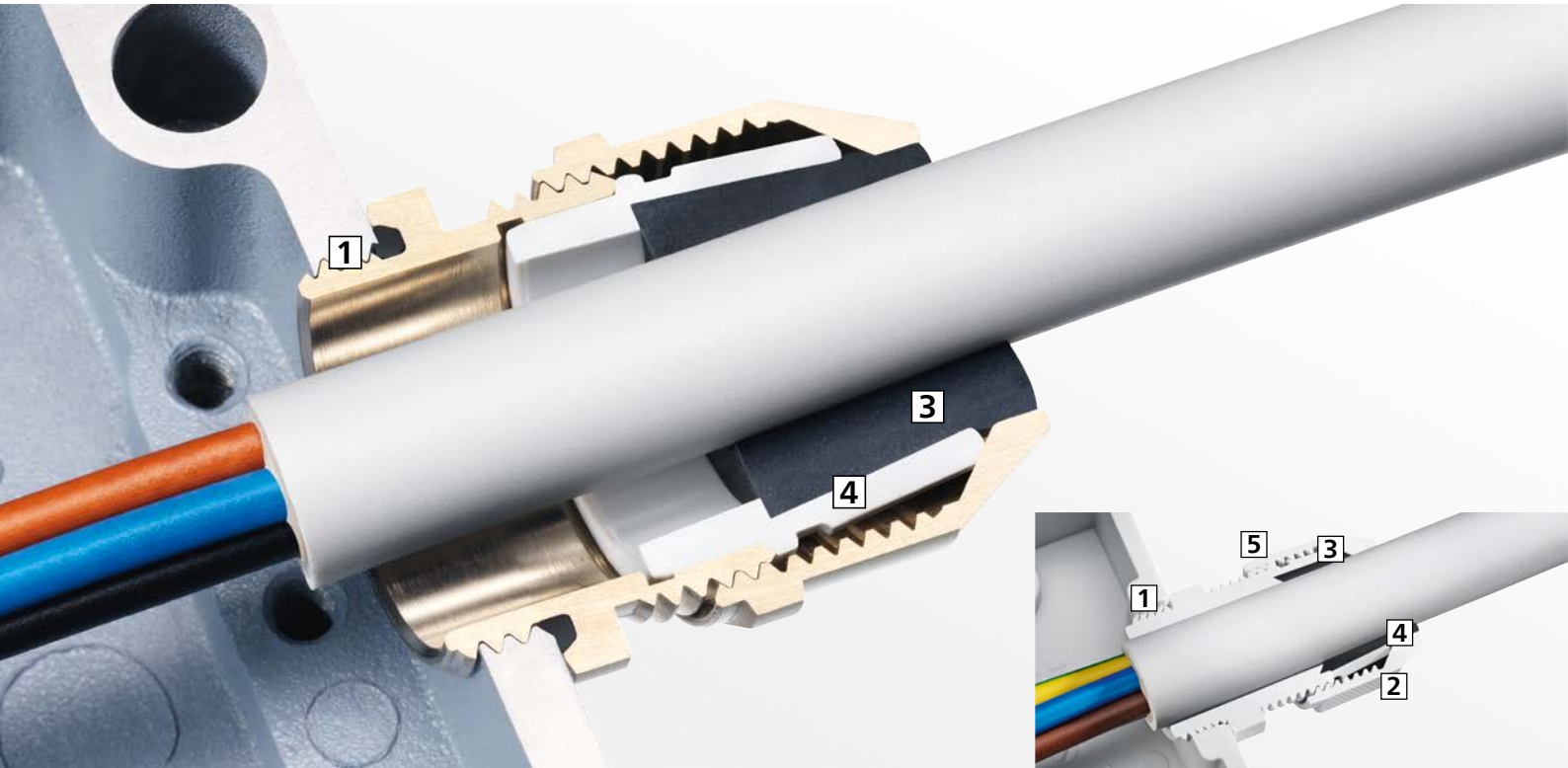

**Kabelverschraubungen Syntec® Messing und Kunststoff** mit innovativer Lamellentechnik. Die beweglichen Gelenklamellen ermöglichen grosse Klemm- und Dichtbereiche für den flexiblen und sicheren täglichen Einsatz. Die Vorfixierung der Kunststoff-Druckmutter erleichtert Überkopf-Montagen sehr.

### 1 Kurzes oder langes Gewinde

Qualitätsverschraubungen mit kurzem oder langem metrischen Gewinde für die sichere Befestigung mit Gewinde oder Gegenmutter.

### 2 Hörbare Sicherheit in Kunststoff

Die Rastnocken der Druckmutter garantieren mit hörbarem „Klick“ immer den vibrations- und rüttelfesten Halt des Kabels.

### 3 Garantierte Dichtigkeit

Die elastischen, umweltbeständigen Dichtringe halten sicher dicht, sind besonders langlebig und garantieren die Schutzart IP 68.

### 4 Einzigartige Lamellentechnik

Die von AGRO entwickelte Lamellengeometrie mit beweglichen Gelenklamellen ermöglicht das Einführen verschiedener Durchmesser in die Syntec® Kabelverschraubung bei hervorragender Zugentlastung und exzellentem Verdreherschutz.

### 5 Grosse Schlüsselflächen in Kunststoff

Der grossflächige Sechskant der Druckmutter bietet immer sicheren und festen Halt beim Festziehen von Hand oder mit dem Werkzeug.

**AGRO Cable glands Syntec® nickel-plated brass and synthetic material** with innovative lamellar technology. The flexible “lamellas” of the segmental ring clamp the cable right around, providing great flexibility in terms of clamping and sealing and thus ensuring reliability and convenience. The pre-assembly of the plastic compression nut simplifies overhead installation.

### 1 Short or long thread

Quality cable glands with a short or long metric thread for secure connection to a threaded hole or using a counter nut.

### 2 Audible confirmation with the plastic version

The design of the compression nut causes an audible “click” that ensures a vibration- and shake-proof grip.

### 3 Ensured leak-tightness

The elastic sealing rings provide a reliable seal, are particularly durable and resistant to environmental influences and.

### 4 Unique lamellar technology

The AGRO-developed design facilitates the insertion of cables of different diameters into the Syntec® cable gland and ensures outstanding strain relief and anti-rotation protection.

### 5 Large spanner flats on the synthetic version

The large hexagonal surface of the compression nuts ensures consistently reliable and secure grip when tightened by hand or using a spanner.

## Trapezförmige Gelenklamellen



1

Die einzigartige Lamellentechnik garantiert eine hervorragende Zugentlastung.



3

Die trapezförmigen Lamellen gleiten beim Anziehen der Kabelverschraubung ineinander und verpressen das Kabel verdrehsicher in ein Sechseck.

## Trapezoidal lamellas

The unique lamellar technology ensures excellent strain relief.



2

When the compression nut of the cable gland is tightened, the single lamellas come together to form a hexagon, clamping the cable tightly and preventing cable rotation.



4

	Syntec® Kunststoff Syntec® synthetic	Standard Standard	Mit Knickschutz With antikink protection	Syntec® Messing Syntec® nickel-plated brass	Standard Standard
<b>Ausführung / Design</b>					
Lamellentechnik Lamellar technology		•	•		•
<b>Gewinde / Thread</b>					
Anschlussgewinde Pg Entry thread Pg		•	•		A
Anschlussgewinde NPT Entry thread NPT		•	•		-
Kurzes Anschlussgewinde metrisch Short entry thread metric		•	•		•
Langes Anschlussgewinde metrisch Long entry thread metric		•	•		•
<b>Dichteinsatz / Sealing insert</b>					
Für Rundkabel For round cables		•	•		•
Standard Dichtring (TPE/CR) Standard sealing ring (TPE/CR)		•	•		•
<b>Technische Besonderheiten / Technical features</b>					
Erhöhter Vibrationsschutz Increased vibration resistance		•	•		-
Knickschutz Antikink protection		-	•		-
<b>Farben / Colours</b>					
Hellgrau RAL 7035 Light grey RL 7035		•	•		-
Dunkelgrau RAL 7001 Dark grey RAL 7001		A	A		-
Schwarz RAL 9005 Black RAL 9005		•	•		-
Messing vernickelt Nickel-plated brass		-	-		•

A = auf Anfrage / upon request

1  
2  
3  
4  
5  
6  
7  
8  
9  
10  
11  
12  
13  
14  
15

# Kabelverschraubungen Syntec® Messing mit Lamellentechnik

## Cable glands Syntec® nickel-plated brass with lamellar technology

### Kurzes Anschlussgewinde metrisch | Short entry thread metric



Material: Messing vernickelt  
 Dichtring: TPE  
 O-Ring: NBR  
 Lamelleneinsatz: Polyamid PA 6  
 Zugentlastung: Ausführung A nach EN 62444  
 Schutzart: IP 68  
 NEMA Type rating: 4X  
 Einsatztemperatur: -40 °C / +100 °C

Material: Nickel-plated brass  
 Sealing ring: TPE  
 O-ring: NBR  
 Lamellar insert: Polyamide PA 6  
 Strain relief: Version A acc. to EN 62444  
 Protection class: IP 68  
 NEMA Type rating: 4X  
 Operation temperature: -40 °C / +100 °C



SYNTEC MS



Einteiliger Dichtring  
 Nicht durchgehend isolierend

One-piece sealing ring  
 not overall length insulated

G	>Ø< min mm	>Ø< max mm	Ø mm	H mm	L mm	Art.-No.	
M12x1.5	1.0	5.0	15	17	5	1045.12.050	50
M12x1.5	3.0	7.0	15	17	5	1045.12.070	50
M16x1.5	2.0	6.0	18	20	5	1045.17.060	50
M16x1.5	4.5	10.0	18	20	5	1045.17.100	50
M20x1.5	3.5	8.0	22	25	6	1045.20.080	50
M20x1.5	7.0	13.0	22	25	6	1045.20.130	50
M25x1.5	5.0	11.0	28	31	7	1045.25.110	25
M25x1.5	10.0	17.0	28	31	7	1045.25.170	25
M32x1.5	7.0	15.0	36	33	8	1045.32.150	25
M32x1.5	13.0	21.0	36	33	8	1045.32.210	25
M40x1.5	15.0	23.0	46	40	8	1045.40.230	10
M40x1.5	19.0	28.0	46	40	8	1045.40.280	10
M50x1.5	20.0	29.0	55	40	9	1045.50.290	5
M50x1.5	25.0	35.0	55	40	9	1045.50.350	5
M63x1.5	28.0	39.0	70	43	10	1045.63.390	5
M63x1.5	35.0	48.0	70	43	10	1045.63.480	5

Auf Anfrage lieferbar:  
 Anschlussgewinde Pg

Available on request:  
 Entry thread Pg

### Langes Anschlussgewinde metrisch | Long entry thread metric



SYNTEC MS



Einteiliger Dichtring  
 Nicht durchgehend isolierend

One-piece sealing ring  
 not overall length insulated

G	>Ø< min mm	>Ø< max mm	Ø mm	H mm	L mm	Art.-No.	
M12x1.5	1.0	5.0	15	17	12	1145.12.050	50
M12x1.5	3.0	7.0	15	17	12	1145.12.070	50
M16x1.5	2.0	6.0	18	20	12	1145.17.060	50
M16x1.5	4.5	10.0	18	20	12	1145.17.100	50
M20x1.5	3.5	8.0	22	25	12	1145.20.080	50
M20x1.5	7.0	13.0	22	25	12	1145.20.130	50
M25x1.5	5.0	11.0	28	31	12	1145.25.110	25
M25x1.5	10.0	17.0	28	31	12	1145.25.170	25
M32x1.5	7.0	15.0	36	33	15	1145.32.150	25
M32x1.5	13.0	21.0	36	33	15	1145.32.210	25
M40x1.5	15.0	23.0	46	40	15	1145.40.230	10
M40x1.5	19.0	28.0	46	40	15	1145.40.280	10
M50x1.5	20.0	29.0	55	40	15	1145.50.290	5
M50x1.5	25.0	35.0	55	40	15	1145.50.350	5
M63x1.5	28.0	39.0	70	43	15	1145.63.390	5
M63x1.5	35.0	48.0	70	43	15	1145.63.480	5
M63x1.5	44.0	55.0	80	43	15	1145.63.550	5

# Kabelverschraubungen Syntec® Kunststoff mit Lamellentechnik Synthetic cable glands Syntec® with lamellar technology

## Kurzes Anschlussgewinde metrisch | Short entry thread metric

Material: Polyamid PA 6  
Eigenschaften: halogenfrei, schwarz UV beständig (getestet nach EN ISO 4892-2)  
Dichtring: TPE oder CR (Neopren)  
Zugentlastung: Ausführung A nach EN 62444  
Schutzart: IP 68  
NEMA Type rating: 4X  
Einsatztemperatur: -30 °C / +100 °C

Material: Polyamide PA 6  
Properties: halogen-free, black UV resistant (tested according to EN ISO 4892-2)  
Sealing ring: TPE or CR (Neoprene)  
Strain relief: Version A acc. to EN 62444  
Protection class: IP 68  
NEMA Type rating: 4X  
Operation temperature: -30 °C / +100 °C

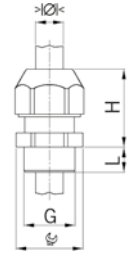

Hellgrau RAL 7035  
Einteiliger Dichtring

Light grey RAL 7035  
One-piece sealing ring

G	$\begin{matrix} > \text{Ø} < \\ \text{min mm} \end{matrix}$	$\begin{matrix} > \text{Ø} < \\ \text{max mm} \end{matrix}$	$\begin{matrix} \text{Ø} \\ \text{mm} \end{matrix}$	H mm	L mm	Art.-No.	
M12x1.5	2.5	6.5	15	21	6	1555.12.06	100
M16x1.5	2.0	6.0	19	25	8	1555.17.06	50
M16x1.5	5.0	10.0	19	25	8	1555.17.10	50
M20x1.5	3.5	8.0	24	29	9	1555.20.08	50
M20x1.5	7.0	13.0	24	29	9	1555.20.13	50
M25x1.5	5.0	11.0	29	38	10	1555.25.11	25
M25x1.5	10.0	17.0	29	38	10	1555.25.17	25
M32x1.5	17.0	25.0	42	36	10	1555.32.25	20

Auf Anfrage lieferbar:  
Dunkelgrau RAL 7001

Available on request:  
Dark grey RAL 7001



SYNTEC



Schwarz RAL 9005  
Einteiliger Dichtring

Black RAL 9005  
One-piece sealing ring

G	$\begin{matrix} > \text{Ø} < \\ \text{min mm} \end{matrix}$	$\begin{matrix} > \text{Ø} < \\ \text{max mm} \end{matrix}$	$\begin{matrix} \text{Ø} \\ \text{mm} \end{matrix}$	H mm	L mm	Art.-No.	
M12x1.5	2.5	6.5	15	21	6	1545.12.06	100
M16x1.5	2.0	6.0	19	25	8	1545.17.06	50
M16x1.5	5.0	10.0	19	25	8	1545.17.10	50
M20x1.5	3.5	8.0	24	29	9	1545.20.08	50
M20x1.5	7.0	13.0	24	29	9	1545.20.13	50
M25x1.5	5.0	11.0	29	38	10	1545.25.11	25
M25x1.5	10.0	17.0	29	38	10	1545.25.17	25
M32x1.5	17.0	25.0	42	36	10	1545.32.25	20



SYNTEC



# Kabelverschraubungen Syntec® Kunststoff mit Lamellentechnik

## Synthetic cable glands Syntec® with lamellar technology

### Langes Anschlussgewinde metrisch | Long entry thread metric

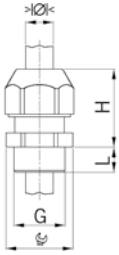

Material: Polyamid PA 6  
 Eigenschaften: halogenfrei, schwarz UV beständig (getestet nach EN ISO 4892-2)  
 Dichtring: TPE oder CR (Neopren)  
 Zugentlastung: Ausführung A nach EN 62444  
 Schutzart: IP 68  
 NEMA Type rating: 4X  
 Einsatztemperatur: -30 °C / +100 °C

Material: Polyamide PA 6  
 Properties: halogen-free, black UV resistant (tested according to EN ISO 4892-2)  
 Sealing ring: TPE or CR (Neoprene)  
 Strain relief: Version A acc. to EN 62444  
 Protection class: IP 68  
 NEMA Type rating: 4X  
 Operation temperature: -30 °C / +100 °C



SYNTEC



Hellgrau RAL 7035  
 Einteiliger Dichtring

Light grey RAL 7035  
 One-piece sealing ring

G	>Ø< min mm	>Ø< max mm	Ø mm	H mm	L mm	Art.-No.	
M12x1.5	2.5	6.5	15	21	12	1555.12.1.06	100
M16x1.5	2.0	6.0	19	25	15	1555.17.1.06	50
M16x1.5	5.0	10.0	19	25	15	1555.17.1.10	50
M20x1.5	3.5	8.0	24	29	15	1555.20.1.08	50
M20x1.5	7.0	13.0	24	29	15	1555.20.1.13	50
M25x1.5	5.0	11.0	29	38	15	1555.25.1.11	25
M25x1.5	10.0	17.0	29	38	15	1555.25.1.17	25
M32x1.5	17.0	25.0	42	36	15	1555.32.1.25	20
M40x1.5	22.0	33.0	53	48	15	1555.40.1.33	10
M50x1.5	28.0	38.0	60	48	15	1555.50.1.38	5
M63x1.5	32.0	44.0	65	49	16	1555.63.1.44	5

Auf Anfrage lieferbar:  
 Dunkelgrau RAL 7001

Available on request:  
 Dark grey RAL 7001



SYNTEC



Schwarz RAL 9005  
 Einteiliger Dichtring

Black RAL 9005  
 One-piece sealing ring

G	>Ø< min mm	>Ø< max mm	Ø mm	H mm	L mm	Art.-No.	
M12x1.5	2.5	6.5	15	21	12	1545.12.1.06	100
M16x1.5	2.0	6.0	19	25	15	1545.17.1.06	50
M16x1.5	5.0	10.0	19	25	15	1545.17.1.10	50
M20x1.5	3.5	8.0	24	29	15	1545.20.1.08	50
M20x1.5	7.0	13.0	24	29	15	1545.20.1.13	50
M25x1.5	5.0	11.0	29	38	15	1545.25.1.11	25
M25x1.5	10.0	17.0	29	38	15	1545.25.1.17	25
M32x1.5	17.0	25.0	42	36	15	1545.32.1.25	20
M40x1.5	22.0	33.0	53	48	15	1545.40.1.33	10
M50x1.5	28.0	38.0	60	48	15	1545.50.1.38	5
M63x1.5	32.0	44.0	65	49	16	1545.63.1.44	5

# Kabelverschraubungen Syntec® Kunststoff mit Lamellentechnik

## Synthetic cable glands Syntec® with lamellar technology

### Anschlussgewinde Pg | Entry thread Pg

Material: Polyamid PA 6  
 Eigenschaften: halogenfrei, schwarz UV beständig (getestet nach EN ISO 4892-2)  
 Dichtring: CR (Neopren)  
 Schutzart: IP 68  
 NEMA Type rating: 4X  
 Einsatztemperatur: -30 °C / +100 °C

Material: Polyamide PA 6  
 Properties: halogen-free, black UV resistant (tested according to EN ISO 4892-2)  
 Sealing ring: CR (neoprene)  
 Protection class: IP 68  
 NEMA Type rating: 4X  
 Operation temperature: -30 °C / +100 °C



Hellgrau RAL 7035  
 Einteiliger Dichtring

Light grey RAL 7035  
 One-piece sealing ring

G	$\begin{matrix} > \text{Ø} < \\ \text{min mm} \end{matrix}$	$\begin{matrix} > \text{Ø} < \\ \text{max mm} \end{matrix}$	$\begin{matrix} \text{Ø} \\ \text{mm} \end{matrix}$	H mm	L mm	Art.-No.	
Pg 7	2.5	6.5	15	21	8	1555.07.06	100
Pg 9	3.0	8.0	19	23	8	1555.09.08	50
Pg 11	2.0	7.0	22	25	8	1555.11.07	50
Pg 11	4.0	10.0	22	25	8	1555.11.10	50
Pg 13	3.0	7.0	24	26	9	1555.13.07	50
Pg 13	5.5	12.0	24	26	9	1555.13.12	50
Pg 16	5.0	11.0	27	30	10	1555.16.11	50
Pg 16	8.5	14.0	27	30	10	1555.16.14	50
Pg 21	6.5	14.0	33	35	11	1555.21.14	25
Pg 21	11.0	18.0	33	35	11	1555.21.18	25
Pg 29	17.0	25.0	42	36	11	1555.29.25	20
Pg 36	22.0	33.0	53	48	15	1555.36.33	10
Pg 42	28.0	38.0	60	48	15	1555.42.38	5
Pg 48	32.0	44.0	65	48	15	1555.48.44	5



SYNTEC



Schwarz RAL 9005  
 Einteiliger Dichtring

Black RAL 9005  
 One-piece sealing ring

G	$\begin{matrix} > \text{Ø} < \\ \text{min mm} \end{matrix}$	$\begin{matrix} > \text{Ø} < \\ \text{max mm} \end{matrix}$	$\begin{matrix} \text{Ø} \\ \text{mm} \end{matrix}$	H mm	L mm	Art.-No.	
Pg 7	2.5	6.5	15	21	8	1545.07.06	100
Pg 9	3.0	8.0	19	23	8	1545.09.08	50
Pg 11	2.0	7.0	22	25	8	1545.11.07	50
Pg 11	4.0	10.0	22	25	8	1545.11.10	50
Pg 13	3.0	7.0	24	26	9	1545.13.07	50
Pg 13	5.5	12.0	24	26	9	1545.13.12	50
Pg 16	5.0	11.0	27	30	10	1545.16.11	50
Pg 16	8.5	14.0	27	30	10	1545.16.14	50
Pg 21	6.5	14.0	33	35	11	1545.21.14	25
Pg 21	11.0	18.0	33	35	11	1545.21.18	25
Pg 29	17.0	25.0	42	36	11	1545.29.25	20
Pg 36	22.0	33.0	53	48	15	1545.36.33	10
Pg 42	28.0	38.0	60	48	15	1545.42.38	5
Pg 48	32.0	44.0	65	48	15	1545.48.44	5



SYNTEC



# Kabelverschraubungen Syntec® Kunststoff mit Lamellentechnik Synthetic cable glands Syntec® with lamellar technology

## Anschlussgewinde NPT | Entry thread NPT

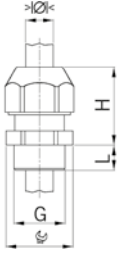

Material: Polyamid PA 6  
Eigenschaften: halogenfrei, schwarz UV beständig (getestet nach EN ISO 4892-2)  
Dichtring: CR (Neopren)  
Schutzart: IP 54  
Gewinde: IP 68, wenn Anschlussgewinde abgedichtet  
NEMA Type rating: 4X  
Einsatztemperatur: -30 °C / +100 °C

Material: Polyamide PA 6  
Properties: halogen-free, black UV resistant (tested according to EN ISO 4892-2)  
Sealing ring: CR (neoprene)  
Protection class: IP 54  
Entry thread: IP 68, if the entry thread is sealed  
NEMA Type rating: 4X  
Operation temperature: -30 °C / +100 °C



SYNTEC



Hellgrau RAL 7035  
Einteiliger Dichtring

Light grey RAL 7035  
One-piece sealing ring

G	> Ø < min mm	> Ø < max mm	Ø mm	H mm	L mm	Art.-No.	
NPT 3/8"	3.0	8.0	19/22	23	15	1555.N0375.08	50
NPT 1/2"	3.0	7.0	24	26	15	1555.N0500.07	50
NPT 1/2"	5.5	12.0	24	26	15	1555.N0500.12	50
NPT 3/4"	6.5	14.0	33	35	15	1555.N0750.14	25
NPT 3/4"	11.0	18.0	33	35	15	1555.N0750.18	25
NPT 1"	17.0	22.0	42	36	15	1555.N1000.22	20



SYNTEC



Schwarz RAL 9005  
Einteiliger Dichtring

Black RAL 9005  
One-piece sealing ring

G	> Ø < min mm	> Ø < max mm	Ø mm	H mm	L mm	Art.-No.	
NPT 3/8"	3.0	8.0	19/22	23	15	1545.N0375.08	50
NPT 1/2"	3.0	7.0	24	26	15	1545.N0500.07	50
NPT 1/2"	5.5	12.0	24	26	15	1545.N0500.12	50
NPT 3/4"	6.5	14.0	33	35	15	1545.N0750.14	25
NPT 3/4"	11.0	18.0	33	35	15	1545.N0750.18	25
NPT 1"	17.0	22.0	42	36	15	1545.N1000.22	20

# Kabelverschraubungen Syntec® Kunststoff mit Lamellentechnik und Knickschutz Synthetic Syntec® cable glands with lamellar technology and anti-kink nozzle

## Kurzes Anschlussgewinde metrisch | Short entry thread metric

Material: Polyamid PA 6  
Eigenschaften: halogenfrei, schwarz UV beständig (getestet nach EN ISO 4892-2)  
Dichtring: CR (Neopren)  
Zugentlastung: Ausführung A nach EN 62444  
Schutzart: IP 68  
NEMA Type rating: 4X  
Einsatztemperatur: -30 °C / +100 °C

Material: Polyamide PA 6  
Properties: halogen-free, black UV resistant (tested according to EN ISO 4892-2)  
Sealing ring: CR (neoprene)  
Strain relief: Version A acc. to EN 62444  
Protection class: IP 68  
NEMA Type rating: 4X  
Operation temperature: -30 °C / +100 °C

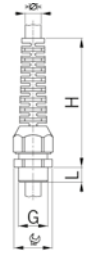

Hellgrau RAL 7035  
Einteiliger Dichtring

Light grey RAL 7035  
One-piece sealing ring

G	> Ø <	> Ø <	mm	H	L	Art.-No.	
	min mm	max mm	mm	mm	mm		
M12x1.5	2.5	6.5	15	54	6	1576.12.06	50
M16x1.5	4.0	8.0	19	64	6	1576.17.08	50
M20x1.5	3.0	7.0	24	88	8	1576.20.07	50
M20x1.5	5.5	12.0	24	88	8	1576.20.12	50



SYNTEC mit  
Knickschutz



Schwarz RAL 9005  
Einteiliger Dichtring

Black RAL 9005  
One-piece sealing ring

G	> Ø <	> Ø <	mm	H	L	Art.-No.	
	min mm	max mm	mm	mm	mm		
M12x1.5	2.5	6.5	15	54	6	1546.12.06	50
M16x1.5	4.0	8.0	19	64	6	1546.17.08	50
M20x1.5	3.0	7.0	24	88	8	1546.20.07	50
M20x1.5	5.5	12.0	24	88	8	1546.20.12	50



SYNTEC mit  
Knickschutz



# Kabelverschraubungen Syntec® Kunststoff mit Lamellentechnik und Knickschutz Synthetic Syntec® cable glands with lamellar technology and anti-kink nozzle

## Langes Anschlussgewinde metrisch | Long entry thread metric

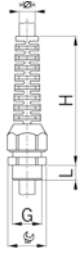

Material: Polyamid PA 6  
Eigenschaften: halogenfrei, schwarz UV beständig (getestet nach EN ISO 4892-2)  
Dichtring: CR (Neopren)  
Zugentlastung: Ausführung A nach EN 62444  
Schutzart: IP 68  
NEMA Type rating: 4X  
Einsatztemperatur: -30 °C / +100 °C

Material: Polyamide PA 6  
Properties: halogen-free, black UV resistant (tested according to EN ISO 4892-2)  
Sealing ring: CR (neoprene)  
Strain relief: Version A acc. to EN 62444  
Protection class: IP 68  
NEMA Type rating: 4X  
Operation temperature: -30 °C / +100 °C



Hellgrau RAL 7035  
Einteiliger Dichtring

Light grey RAL 7035  
One-piece sealing ring

G	>Ø < min mm	>Ø < max mm	Ø mm	H mm	L mm	Art.-No.	
M12x1.5	2.5	6.5	15	54	12	1576.12.1.06	50
M16x1.5	4.0	8.0	19	64	12	1576.17.1.08	50
M20x1.5	3.0	7.0	24	88	13	1576.20.1.07	50
M20x1.5	5.5	12.0	24	88	13	1576.20.1.12	50

SYNTEC mit Knickschutz



Schwarz RAL 9005  
Einteiliger Dichtring

Black RAL 9005  
One-piece sealing ring

G	>Ø < min mm	>Ø < max mm	Ø mm	H mm	L mm	Art.-No.	
M12x1.5	2.5	6.5	15	54	12	1546.12.1.06	50
M16x1.5	4.0	8.0	19	64	12	1546.17.1.08	50
M20x1.5	3.0	7.0	24	88	13	1546.20.1.07	50
M20x1.5	5.5	12.0	24	88	13	1546.20.1.12	50

SYNTEC mit Knickschutz



# Kabelverschraubungen Syntec® Kunststoff mit Lamellentechnik und Knickschutz Synthetic Syntec® cable glands with lamellar technology and anti-kink nozzle

## Anschlussgewinde Pg | Entry thread Pg

Material: Polyamid PA 6  
Eigenschaften: halogenfrei, schwarz UV beständig (getestet nach EN ISO 4892-2)  
Dichtring: CR (Neopren)  
Schutzart: IP 68  
NEMA Type rating: 4X  
Einsatztemperatur: -30 °C / +100 °C

Material: Polyamide PA 6  
Properties: halogen-free, black UV resistant (tested according to EN ISO 4892-2)  
Sealing ring: CR (neoprene)  
Protection class: IP 68  
NEMA Type rating: 4X  
Operation temperature: -30 °C / +100 °C

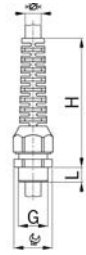

Hellgrau RAL 7035  
Einteiliger Dichtring

Light grey RAL 7035  
One-piece sealing ring

G	>Ø< min mm	>Ø< max mm	 mm	H mm	L mm	Art.-No.	
Pg 7	2.5	6.5	15	54	8	1576.07.06	50
Pg 9	3.0	8.0	19	64	8	1576.09.08	50
Pg 11	2.0	7.0	22	77	8	1576.11.07	50
Pg 11	4.0	10.0	22	77	8	1576.11.10	50
Pg 13	3.0	7.0	24	88	9	1576.13.07	50
Pg 13	5.5	12.0	24	88	9	1576.13.12	50
Pg 16	5.0	11.0	27	102	10	1576.16.11	50
Pg 16	8.5	14.0	27	102	10	1576.16.14	50



SYNTEC mit  
Knickschutz



Schwarz RAL 9005  
Einteiliger Dichtring

Black RAL 9005  
One-piece sealing ring

G	>Ø< min mm	>Ø< max mm	 mm	H mm	L mm	Art.-No.	
Pg 7	2.5	6.5	15	54	8	1546.07.06	50
Pg 9	3.0	8.0	19	64	8	1546.09.08	50
Pg 11	2.0	7.0	22	77	8	1546.11.07	50
Pg 11	4.0	10.0	22	77	8	1546.11.10	50
Pg 13	3.0	7.0	24	88	9	1546.13.07	50
Pg 13	5.5	12.0	24	88	9	1546.13.12	50
Pg 16	5.0	11.0	27	102	10	1546.16.11	50
Pg 16	8.5	14.0	27	102	10	1546.16.14	50



SYNTEC mit  
Knickschutz



# Kabelverschraubungen Syntec® Kunststoff mit Lamellentechnik und Knickschutz Synthetic Syntec® cable glands with lamellar technology and anti-kink nozzle

## Anschlussgewinde NPT | Entry thread NPT

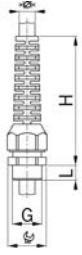

Material: Polyamid PA 6  
Eigenschaften: halogenfrei, schwarz UV beständig (getestet nach EN ISO 4892-2)  
Dichtring: CR (Neopren)  
Schutzart: IP 54  
Gewinde: IP 68, wenn Anschlussgewinde abgedichtet  
NEMA Type rating: 4X  
Einsatztemperatur: -30 °C / +100 °C

Material: Polyamide PA 6  
Properties: halogen-free, black UV resistant (tested according to EN ISO 4892-2)  
Sealing ring: CR (neoprene)  
Protection class: IP 54  
Entry thread: IP 68, if the entry thread is sealed  
NEMA Type rating: 4X  
Operation temperature: -30 °C / +100 °C



Hellgrau RAL 7035  
Einteiliger Dichtring

Light grey RAL 7035  
One-piece sealing ring

G	> Ø <	> Ø <	Ø	H	L	Art.-No.	
	min mm	max mm	mm	mm	mm		
NPT 3/8"	3.0	8.0	19/22	64	15	<b>1576.N0375.08</b>	50
NPT 1/2"	3.0	7.0	24	88	15	<b>1576.N0500.07</b>	50
NPT 1/2"	5.5	12.0	24	88	15	<b>1576.N0500.12</b>	50

SYNTEC mit  
Knickschutz



Schwarz RAL 9005  
Einteiliger Dichtring

Black RAL 9005  
One-piece sealing ring

G	> Ø <	> Ø <	Ø	H	L	Art.-No.	
	min mm	max mm	mm	mm	mm		
NPT 3/8"	3.0	8.0	19/22	64	15	<b>1546.N0375.08</b>	50
NPT 1/2"	3.0	7.0	24	88	15	<b>1546.N0500.07</b>	50
NPT 1/2"	5.5	12.0	24	88	15	<b>1546.N0500.12</b>	50

SYNTEC mit  
Knickschutz





Winkel-Kabelverschraubungen 90° Kunststoff Cable glands elbow 90° synthetic		<b>249</b>
Flanschwinkel 90° Kunststoff Synthetic flanged elbow 90°		<b>250</b>
Quickseal Kabeleinführungstüllen Quickseal cable grommets		<b>251</b>
Würgenippel Kunststoff Synthetic locking plug		<b>252</b>

1

2

3

4

5

6

7

8

9

10

11

12

**13**

14

15



# Flanschwinkel und Winkel

## Flanged elbows and elbows



Sind bei der Kabelinstallation enge Raumverhältnisse gegeben, kann der Anwender auf die Vorteile von **Winkeln und Flanschwinkeln** bauen.

Hier werden Leitungen um die Ecke geführt und je nach der verwendeten Kabelverschraubung zu 100% vor der Knickstelle zugentlastet.

Bei den Kunststoff-Flanschwinkeln erleichtert zudem ein spezieller Klappmechanismus die Kabelinstallation.

Die Quickseal Kabeleinführungstüllen sind spezielle Durchführungsmembranen und können auch als Verschlussstopfen verwendet werden. Zur Montage wird kein Werkzeug benötigt. Einfach Kabeldurchführung einstecken. Danach wird die geschlossene Membran durch Einstecken des durchzuführenden Kabels durchstossen.

Die Würgenippel aus Kunststoff sind für den Einsatz in Installationsbereichen ohne besonderen Einsatz bestens geeignet. Erhältlich mit und ohne Bohrung.

If space is limited, the user can take advantage of the benefits of **elbow fittings – either flanged or unflanged** – for cable installations.

The cables are routed around the bend and, depending upon the type of cable gland used, completely relieved of any strain before the bend.

In the case of flanged elbow fittings made of plastic, their special two-part design simplifies cable installation.

Quickseal cable grommets are special feedthrough membranes which can also be used as sealing caps. No tools are needed for installation – simply insert the cable grommet. Afterwards, the cable to be fed through is simply pushed through the closed membrane.

The synthetic sealing plugs are especially well suited for use in electrical installation work requiring little effort or expertise. Available with or without feedthrough holes.

# Winkel-Kabelverschraubungen 90° Kunststoff

## Cable glands elbow 90° synthetic

### Anschlussgewinde metrisch | Entry thread metric

Material: Polycarbonat  
 Dichtung: TPE  
 Schutzart: IP 68  
 Einsatztemperatur: -20 °C / +100 °C

Material: Polycarbonat  
 Seal: TPE  
 Protection class: IP 68  
 Operation temperature: -20 °C / +100 °C

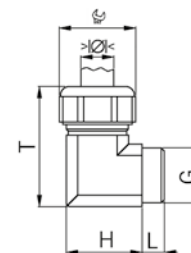

Grau RAL 7032  
 Einteiliger Dichteinsatz

Grey RAL 7032  
 One-piece sealing insert

G	$\begin{matrix} > < \\ \text{min mm} \end{matrix}$	$\begin{matrix} > < \\ \text{max mm} \end{matrix}$	$\begin{matrix} \text{mm} \\ \text{mm} \end{matrix}$	H	T	L	Art.-No.	
M16x1.5	6.5	9.5	19	23	38	8	5215.17.95	25
M20x1.5	7.0	10.5	24	28	46	9	5215.20.105	25
M20x1.5	9.0	13.0	24	28	46	9	5215.20.13	25
M25x1.5	11.5	15.5	27	32	52	10	5215.25.155	25



Schwarz RAL 9005  
 Einteiliger Dichteinsatz

Black RAL 9005  
 One-piece sealing insert

G	$\begin{matrix} > < \\ \text{min mm} \end{matrix}$	$\begin{matrix} > < \\ \text{max mm} \end{matrix}$	$\begin{matrix} \text{mm} \\ \text{mm} \end{matrix}$	H	T	L	Art.-No.	
M16x1.5	6.5	9.5	19	23	38	8	5215.17.40.95	25
M20x1.5	7.0	10.5	24	28	46	9	5215.20.40.105	25
M20x1.5	9.0	13.0	24	28	46	9	5215.20.40.13	25
M25x1.5	11.5	15.5	27	32	52	10	5215.25.40.155	25



### Anschlussgewinde Pg | Entry thread Pg

Grau RAL 7032  
 Einteiliger Dichteinsatz

Grey RAL 7032  
 One-piece sealing insert

G	$\begin{matrix} > < \\ \text{min mm} \end{matrix}$	$\begin{matrix} > < \\ \text{max mm} \end{matrix}$	$\begin{matrix} \text{mm} \\ \text{mm} \end{matrix}$	H	T	L	Art.-No.	
Pg 9	4.5	6.5	19	23	38	8	5215.09.65	25
Pg 9	6.5	9.5	19	23	38	8	5215.09.95	25
Pg 11	7.0	10.5	22	25	42	9	5215.11.105	25
Pg 11	4.0	6.5	22	25	42	9	5215.11.65	25
Pg 11	6.5	9.5	22	25	42	9	5215.11.95	25
Pg 13	7.0	10.5	24	28	46	9	5215.13.105	25
Pg 13	9.0	13.0	24	28	46	9	5215.13.13	25
Pg 13	6.5	9.5	24	32	46	9	5215.13.95	25
Pg 16	7.0	10.5	27	32	52	10	5215.16.105	25
Pg 16	9.0	13.0	27	32	52	10	5215.16.13	25
Pg 16	11.5	15.5	27	32	52	10	5215.16.155	25
Pg 16	6.5	9.5	27	32	52	10	5215.16.95	25



# Flanschwinkel 90° Kunststoff

## Synthetic flanged elbow 90°

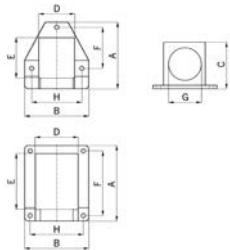

### Anschlussgewinde metrisch | Entry thread metric



Material: Polyamid  
 Dichtung: NBR  
 Schutzart: IP 65  
 Eigenschaften: Der Flanschwinkel lässt sich aufklappen.  
 Einsatztemperatur: -40 °C / +110 °C



Material: Polyamide  
 Seal: NBR  
 Protection class: IP 65  
 Properties: The flange angle can be unfolded.  
 Operation temperature: -40 °C / +110 °C



Schwarz									Black		
G	A mm	B mm	C mm	D mm	E mm	F mm	H mm		Art.-No.		
M16x1.5	49	47	35	22	27	29	37	3	5500.40.17	10	
M20x1.5	49	47	35	22	27	29	37	3	5500.40.20	10	
M25x1.5	69	65	44	30	31	42	52	3	5500.40.25	10	
M32x1.5	90	78	55	40	65	65	65	4	5500.40.32	10	
M40x1.5	100	94	66	48	68	80	80	4	5500.40.40	5	
M50x1.5	116	101	76	63	85	88	88	4	5500.40.50	5	

### Anschlussgewinde Pg | Entry thread Pg



Schwarz									Black		
G	A mm	B mm	C mm	D mm	E mm	F mm	H mm		Art.-No.		
Pg 11	49	47	35	22	27	29	37	3	5540.11	10	
Pg 16	49	47	35	22	27	29	37	3	5540.16	10	
Pg 21	69	65	44	30	31	42	52	3	5540.21	10	
Pg 29	90	78	55	40	65	65	65	4	5540.29	10	
Pg 36	100	94	66	48	68	80	80	4	5540.36	5	
Pg 48	116	101	76	63	85	88	88	4	5540.48.48	5	

### Metrische Nenngrossen | Metric rating

Material: EPDM  
 Schutzart: IP 67  
 Eigenschaften: Halogenfrei, allseitig IP 67 durch 'Pushout-Membrane', gute Chemikalien- und Witterungsbeständigkeit

Einsatzbereich: Universell einsetzbar bei Wandstärken von 1 bis 4 mm (M16 - M50) bzw. 0.5 bis 2 mm (M12)

Einsatztemperatur: -40 °C / +110 °C

Material: EPDM  
 Protection class: IP 67  
 Properties: Halogen-free, all-round IP 67 protection thanks to the "pushout-membrane", resistant to chemicals and weatherproof

Application: Suitable for holes in materials of 1 - 4 mm (M16 - M50), or M12 from 0.5 - 2 mm

Operation temperature: -40 °C / +110 °C

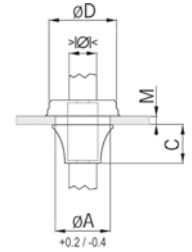

Dunkelgrau RAL 7001						Dark grey RAL 7001	
ØA mm	> Ø < min mm	> Ø < max mm	M mm	C mm	ØD mm	Art.-No.	
12.5	4.0	7.0	0.5-2	5.6	20.0	14.582.33	50
16.5	5.0	9.0	1-4	11.0	21.0	14.582.34	50
20.5	8.0	13.0	1-4	13.4	25.5	14.582.35	50
25.5	11.0	17.0	1-4	15.3	30.5	14.582.36	50
32.5	15.0	20.0	1-4	18.6	38.5	14.582.37	25
40.5	19.0	28.0	1-4	21.7	48.5	14.582.38	25
50.5	27.0	35.0	1-4	25.0	60.5	14.582.39	10



Hellgrau RAL 7035						Light grey RAL 7035	
ØA mm	> Ø < min mm	> Ø < max mm	M mm	C mm	ØD mm	Art.-No.	
12.5	4.0	7.0	0.5-2	5.6	20.0	14.583.03	50
16.5	5.0	9.0	1-4	11.0	21.0	14.583.04	50
20.5	8.0	13.0	1-4	13.4	25.5	14.583.05	50
25.5	11.0	17.0	1-4	15.3	30.5	14.583.06	50
32.5	15.0	20.0	1-4	18.6	38.5	14.583.07	25
40.5	19.0	28.0	1-4	21.7	48.5	14.583.08	25
50.5	27.0	35.0	1-4	25.0	60.5	14.583.09	10



Schwarz RAL 9005						Black RAL 9005	
ØA mm	> Ø < min mm	> Ø < max mm	M mm	C mm	ØD mm	Art.-No.	
12.5	4.0	7.0	0.5-2	5.6	20.0	14.582.93	50
16.5	5.0	9.0	1-4	11.0	21.0	14.582.94	50
20.5	8.0	13.0	1-4	13.4	25.5	14.582.95	50
25.5	11.0	17.0	1-4	15.3	30.5	14.582.96	50
32.5	15.0	20.0	1-4	18.6	38.5	14.582.97	25
40.5	19.0	28.0	1-4	21.7	48.5	14.582.98	25
50.5	27.0	35.0	1-4	25.0	60.5	14.582.99	10



1  
2  
3  
4  
5  
6  
7  
8  
9  
10  
11  
12  
13  
14  
15

# Würgenippel Kunststoff

## Synthetic locking plug

### Anschlussgewinde metrisch | Entry thread metric

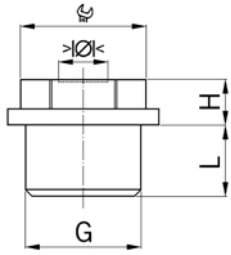

Material: Polyethylen  
 Schutzart: IP 54  
 Einsatztemperatur: -20 °C / +70 °C

Material: Polyethylene  
 Protection class: IP 54  
 Operation temperature: -20 °C / +70 °C



Hellgrau RAL 7035  
 Mit Bohrung

Light grey RAL 7035  
 with bore hole

G	> Ø < min mm	> Ø < max mm	mm	H mm	L mm	Art.-No.	
<b>M16x1.5</b>	5.0	10.8	15	7	10	<b>1620.17</b>	100
<b>M20x1.5</b>	8.0	13.5	19	8	12	<b>1620.20</b>	100
<b>M25x1.5</b>	9.0	16.0	24	10	12	<b>1620.25</b>	100
<b>M32x1.5</b>	11.0	22.0	30	11	14	<b>1620.32</b>	50
<b>M40x1.5</b>	17.0	24.0	37	12	16	<b>1620.40</b>	25
<b>M50x1.5</b>	22.0	35.0	46	13	18	<b>1620.50</b>	10
<b>M63x1.5</b>	24.0	43.0	56	15	20	<b>1620.63</b>	10



Hellgrau RAL 7035  
 Ohne Bohrung

Light grey RAL 7035  
 without bore hole

G	> Ø < min mm	> Ø < max mm	mm	H mm	L mm	Art.-No.	
<b>M16x1.5</b>	5.0	10.8	15	7	10	<b>1600.17</b>	100
<b>M20x1.5</b>	8.0	13.5	19	8	12	<b>1600.20</b>	100
<b>M25x1.5</b>	9.0	16.0	24	10	12	<b>1600.25</b>	100
<b>M32x1.5</b>	11.0	22.0	30	11	14	<b>1600.32</b>	100
<b>M40x1.5</b>	17.0	24.0	37	12	16	<b>1600.40</b>	25
<b>M50x1.5</b>	22.0	35.0	46	13	18	<b>1600.50</b>	10
<b>M63x1.5</b>	24.0	43.0	56	15	20	<b>1600.63</b>	10



<p>Druckausgleichselemente Messing, Kunststoff und Edelstahl Pressure balance elements nickel-plated brass, synthetic and stainless steel</p>		<p>256 - 260</p>	<p>1</p>
<p>Universal-Drehadapter und Richtungsfeststeller Messing Universal swivel adapters and adjustable fixing devices nickel-plated brass</p>		<p>261</p>	<p>2</p>
<p>Gegenmuttern Messing und Edelstahl Sealing nuts nickel-plated brass and stainless steel</p>		<p>262 - 266</p>	<p>3</p>
<p>Gegenmuttern und Kantenschutz Kunststoff Synthetic lock nuts and anti-abrasion nut</p>		<p>265 - 271</p>	<p>4</p>
<p>Reduktionen und Erweiterungen Messing Reduction and enlarging fittings nickel-plated brass</p>		<p>272 - 281</p>	<p>5</p>
<p>Reduktionen und Erweiterungen Kunststoff Synthetic reduction and enlarging fittings</p>		<p>282 - 285</p>	<p>6</p>
<p>Verschlusschrauben Metall und Kunststoff Sealing plugs metal and synthetic</p>		<p>286 - 291</p>	<p>7</p>
<p>Dichteinsätze Vollgummi Solid rubber sealing inserts</p>		<p>292 - 293</p>	<p>8</p>
<p>O-Ringe und Dichtungsscheiben O-rings and sealing washers</p>		<p>294 - 297</p>	<p>9</p>
<p>Blindscheiben, Verschlussbolzen, Einschnittringe Blind discs, locking pins, sealing rings</p>		<p>298 - 299</p>	<p>10</p>
<p>Spezialwerkzeug Special tool</p>		<p>300</p>	<p>11</p>
<p>AGRO Geflechtschläuche Kunststoff AGRO Synthetic braided cable sleeving</p>		<p>301 - 309</p>	<p>12</p>

# Zubehör zu Kabelverschraubungen

## Cable gland accessories



Dank einer Reihe kleiner Helfer bei der Kabeleinführung lassen sich Produktionsanlagen problemlos an neue Aufgaben oder Gegebenheiten anpassen. Dabei kann nicht nur die Anzahl der Leitungen abweichen, sondern es können sich auch etliche Kabeldurchmesser ändern. Um hier den Arbeitsaufwand an Gehäusen und Schaltschränken zu minimieren, empfiehlt sich der Einsatz von Erweiterungen und Reduktionen. So können zum Beispiel einzelne Adern von dicken Kabeln durch eine Erweiterung in das Gehäuse eingeführt werden, wobei die äussere Leitungsisolierung in der Kabelverschraubung endet. Hierbei bleibt die vorhandene Schutzart selbstverständlich erhalten.

Überflüssige Gehäuseöffnungen werden durch den Einsatz von Verschlusschrauben abgedichtet und somit vor dem Eindringen von Schmutz bewahrt.

Falls keine Gewindebohrung vorhanden ist, können Gegenmuttern verwendet werden.

Thanks to a range of cable entry accessories, production systems can be easily adapted to new tasks or situations. Not only can the number of cables change, but the cable diameters can also. To minimise the work on housings and control cabinets, the use of reduction and enlarging fittings may be recommended. An enlarging fitting, for example, can be used to route the individual wires of a thick cable into a housing with the outer cable insulation terminating in the cable gland. It goes without saying that the existing protection class is maintained.

Redundant housing openings can be blocked using locking screws to prevent the ingress of dirt.

If existing holes are not threaded, locknuts can be used.

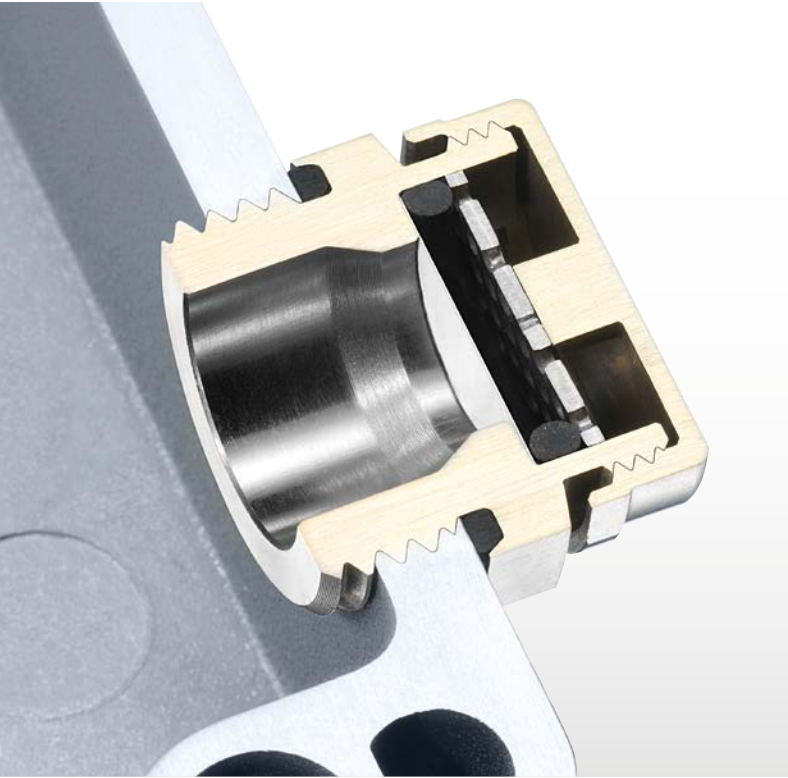

Eine effiziente Belüftung steigert die Leistungsfähigkeit eines Produkts erheblich. AGRO bietet ein innovatives Portfolio, das die Zuverlässigkeit und Lebensdauer elektronischer Komponenten für den Ausseninsatz erhöht.

- schneller Druckausgleich, Reduzierung von Kondensation
- Schutz gegen Flüssigkeiten, Öl und Schmutz

### Entwässerungselement mit Sieb:

Bei Anwendungen mit unvermeidlicher Kondenswasserbildung kommen Entwässerungselemente zum Einsatz. Das Edelstahlsieb ermöglicht den schnellen Wasserabfluss und schützt gleichzeitig mit feiner Maschengröße vor Insekten und Schmutz (> 0.2 mm). Zur Optimierung des Wasserabflusses werden unsere partiell geschlitzten Gegenmutter empfohlen.

### Druckausgleichselemente aus Kunststoff, Messing oder rostfreiem Stahl A4:

Die Membrane verfügt über Poren, die so fein sind, dass Wasserdampfmoleküle hindurchpassen, Wassertropfen jedoch zurückgehalten werden. So sorgt sie für einen problemlosen Luftaustausch und ein trockenes Innengehäuse. Die Membrane ist wasser-, öl- und schmutzabweisend. Das Druckausgleichselement ist auch in Ex-Ausführung für erhöhte Sicherheit Ex e II erhältlich.

### Druckausgleichselement mit Sinterfilter:

Durch den Materialaufbau der Sinterscheibe ist ein wesentlich grösserer Luftaustausch möglich. Extreme Druck- und Feuchtigkeitsschwankungen können mühelos ausgeglichen werden. Die Sinterscheibe ist spritzwasser- und insektensicher.

### Druckausgleichselemente aus rostfreiem Stahl A4:

Für besonders anspruchsvolle Anwendungen hat AGRO Druckausgleichselemente aus rostfreiem Stahl A4 entwickelt. Diese Ausführung kombiniert eine robuste Bauweise mit einer Hochleistungsmembrane. Sie ist korrosionsbeständig, widersteht aggressiven Medien und eignet sich daher ideal für Einsätze in der Verkehrs- und Signaltechnik, Strassenbeleuchtung, Bahn, Energieverteilung oder Solartechnik, ebenso wie in Küstenregionen oder auf See.

Efficient ventilation significantly increases a product's performance. AGRO offers an innovative portfolio that improves the reliability and service life of electronic components for outdoor use.

- fast pressure compensation, reduction of condensation
- protection against liquids, oil and dirt

### Drainage element with mesh:

In applications where condensation of water is unavoidable, drainage elements are used. The stainless steel mesh allows water to drain away quickly and, thanks to its fine mesh size, also protects against insects and dirt particles larger than 0.2 mm. For optimal drainage, our partially slotted counter nuts are recommended.

### Pressure balance elements made of synthetic material, brass or stainless steel A4 with membrane:

The membrane has pores so fine that water vapour molecules can pass through, while water droplets are retained. This ensures easy air exchange and keeps the inside of the housing dry. The membrane is water-, oil- and dirt-repellent. The pressure balance element is also available in an Ex version for increased safety Ex e II.

### Pressure balance element with sinter filter:

The material structure of the sinter disc allows significantly greater air transfer. Extreme pressure and moisture fluctuations can be easily balanced. The sinter disc protects against splashing water and insects.

### Pressure balance elements made of stainless steel A4:

For particularly demanding applications, AGRO has developed pressure balance elements made of stainless steel A4. This version combines a robust design with a high-performance membrane. It is corrosion-resistant, withstands aggressive media and is therefore ideally suited for use in traffic and signal technology, street lighting, railway vehicles, energy distribution or solar installations, as well as in coastal regions or at sea.

# Kunststoff Druckausgleichselement mit Membrane

## Synthetic pressure balance element with membrane

### Anschlussgewinde metrisch | Entry thread metric

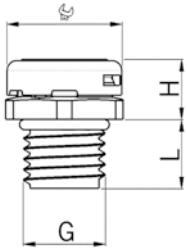

Material:	Polyamid PA 6
Membrane:	PTFE (Polyterafluorethylen) frei von PFOA und PFOS
O-Ring:	NBR
Schutzart:	IP 66 / IP 68 / IP 69
Wassereintrittsdruck:	IP 68 = 0.1 bar / 30 min
Luftdurchsatz:	> 6.51 l/min / cm <sup>2</sup> bei 700 mbar Luftdurchsatz siehe Leistungs- erklärung auf der Website
Eigenschaften:	halogenfrei, schwarz UV beständig (getestet nach EN ISO 4892-2)
Einsatztemperatur:	-40 °C / +100 °C

Material:	Polyamide PA 6
Membrane:	PTFE (polyterafluoroethy- lene) free from PFOA and PFOS
O-ring:	NBR
Protection class:	IP 66 / IP 68 / IP 69
Water intrusion pressure:	IP 68 = 0.1 bar / 30 min
Air flow rate:	> 6.51 ml/min / cm <sup>2</sup> at 700 mbar For air flow rate, see per- formance declaration on the website.
Properties:	halogen-free, black UV resistant (tested accord- ing to EN ISO 4892-2)
Operation temperature:	-40 °C / +100 °C



Schwarz RAL 9005  
Mit Membrane

Black RAL 9005  
with membrane

<b>G</b>		<b>H</b>	<b>L</b>
	mm	mm	mm
<b>M12x1.5</b>	17	9	10

**Art.-No.**



**2445.12**

25

### Anschlussgewinde metrisch | Entry thread metric

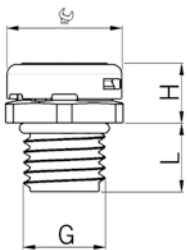

Material:	Polyamid PA 6
Membrane:	PTFE (Polyterafluorethylen) frei von PFOA und PFOS
O-Ring:	NBR
Schutzart:	IP 66 / IP 68 / IP 69
Wassereintrittsdruck:	IP 68 = 0.1 bar / 30 min
Luftdurchsatz:	> 6.51 l/min / cm <sup>2</sup> bei 700 mbar Luftdurchsatz siehe Leistungs- erklärung auf der Website
Eigenschaften:	halogenfrei
Einsatztemperatur:	-40 °C / +100 °C

Material:	Polyamide PA 6
Membrane:	PTFE (polyterafluoroethy- lene) free from PFOA and PFOS
O-ring:	NBR
Protection class:	IP 66 / IP 68 / IP 69
Water intrusion pressure:	IP 68 = 0.1 bar / 30 min
Air flow rate:	> 6.51 ml/min / cm <sup>2</sup> at 700 mbar For air flow rate, see per- formance declaration on the website.
Properties:	halogen-free
Operation temperature:	-40 °C / +100 °C



Hellgrau RAL 7035  
Mit Membrane

Light grey RAL 7035  
with membrane

<b>G</b>		<b>H</b>	<b>L</b>
	mm	mm	mm
<b>M12x1.5</b>	17	9	10

**Art.-No.**



**2455.12**

25

# Druckausgleichselement Messing mit Membrane

## Pressure balance element nickel-plated brass with membrane

### Anschlussgewinde metrisch | Entry thread metric

Material:	Messing vernickelt	Material:	Nickel-plated brass
Membrane:	PTFE (Polyterafluorethylen) frei von PFOA und PFOS	Membrane:	PTFE (polyterafluoroethylene) free from PFOA and PFOS
O-Ring:	NBR	O-ring:	NBR
Schutzart:	IP 66 / IP 68 / IP 69	Protection class:	IP 66 / IP 68 / IP 69
Wassereintrittsdruck:	IP 68 = 0.3 bar / 30 min	Water intrusion pressure:	IP 68 = 0.3 bar / 30 min
Luftdurchsatz:	1.) > 4.79 l/min / cm <sup>2</sup> bei 700 mbar 2.) > 9.91 l/min / cm <sup>2</sup> bei 700 mbar Luftdurchsatz siehe Leistungs- erklärung auf der Website	Air flow rate:	1.) > 4.79 ml/min / cm <sup>2</sup> at 700 mbar 2.) > 9.91 ml/min / cm <sup>2</sup> at 700 mbar For air flow rate, see per- formance declaration on the website.
Einsatztemperatur:	-60 °C / +100 °C	Operation temperature:	-60 °C / +100 °C

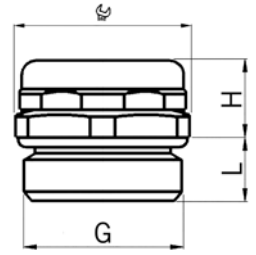

Mit Membrane Mit O-Ring		with membrane with O-ring	
<b>G</b>		<b>H</b>	<b>L</b> <b>i</b>
	mm	mm	mm info
<b>M12x1.5</b>	18	9.5	8 1
<b>M16x1.5</b>	18	9.5	8 1
<b>M20x1.5</b>	22	10.0	8 2
			<b>Art.-No.</b>
			<b>2450.12.34</b> 25
			<b>2450.17.34</b> 20
			<b>2450.20.34</b> 20



### Anschlussgewinde Pg | Entry thread Pg

Mit Membrane Mit O-Ring		with membrane with O-ring	
<b>G</b>		<b>H</b>	<b>L</b> <b>i</b>
	mm	mm	mm info
<b>Pg 7</b>	18	9.5	8 1
<b>Pg 11</b>	22	10.0	8 2
			<b>Art.-No.</b>
			<b>2450.07.34</b> 25
			<b>2450.11.34</b> 20



1  
2  
3  
4  
5  
6  
7  
8  
9  
10  
11  
12  
13  
14  
15

# Druckausgleichselement Stahl A4 mit Membrane

## Pressure balance element steel A4 with membrane

### Anschlussgewinde metrisch | Entry thread metric

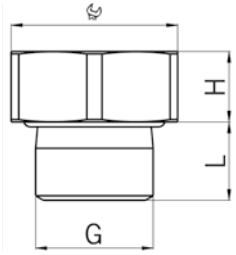

Material:	Rostfreier Stahl A4 (EN 1.4404 / AISI 316L)	Material:	Stainless steel A4 (EN 1.4404 / AISI 316L)
Membrane:	PTFE (Polyterafluorethylen) frei von PFOA und PFOS	Membrane:	PTFE (polyterafluoroethylene) free from PFOA and PFOS
Formdichtung:	Silikon	Molded seal:	Silicone
O-Ring:	Silikon	O-ring:	Silicone
Schutzart:	IP 66 / IP68 (0.5 bar/1h) / IP69 / IP6K9K	Protection class:	IP 66 / IP68 (0.5 bar/1h) / IP69 / IP6K9K
Schlagtest:	IK10 (IEC 62262)	Impact test:	IK10 (IEC 62262)
Luftdurchsatz:	> 14.00 l/min /cm <sup>2</sup> bei 700 mbar Luftdurchsatz siehe Leistungs- erklärung auf der Website	Air flow rate:	> 14.00 ml/min / cm <sup>2</sup> at 700 mbar For air flow rate, see per- formance declaration on the website.
Einsatztemperatur:	-60 °C / +150 °C	Operation temperature:	-60 °C / +150 °C



Mit Membrane  
Mit O-Ring

with membrane  
with O-ring

<b>G</b>		<b>H</b>	<b>L</b>
	mm	mm	mm
<b>M12x1.5</b>	17	7	8

Art.-No.



**2460.12.97.34**

10

Patent angemeldet

Patent pending



# Druckausgleichselement Messing mit Sinterfilter

## Pressure balance element nickel-plated brass with sintered filter

### Anschlussgewinde metrisch | Entry thread metric

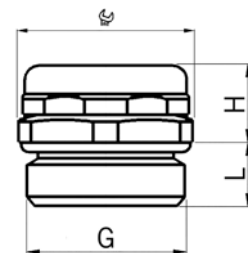

Material:	Messing vernickelt	Material:	Nickel-plated brass
Filterscheibe:	Sinterbronze	Filter disc:	Sintered bronze
O-Ring:	NBR	O-ring:	NBR
Schutzart:	IP 54 / IP x9	Protection class:	IP 54 / IP x9
Filtergrad:	40 µm	Degree of filter:	40 µm
Luftdurchsatz:	1.) > 59.70 l/min / cm <sup>2</sup> bei 700 mbar 2.) > 91.30 l/min / cm <sup>2</sup> bei 700 mbar Luftdurchsatz siehe Leistungs- erklärung auf der Website	Air flow rate:	1.) > 59.70 ml/min / cm <sup>2</sup> at 700 mbar 2.) > 91.30 ml/min / cm <sup>2</sup> at 700 mbar For air flow rate, see per- formance declaration on the website.
Einsatztemperatur:	-50 °C / +110 °C	Operation temperature:	-50 °C / +110 °C



Mit Sinterfilter Mit O-Ring	Sintered filter with O-ring		
<b>G</b>	 <b>H</b> <b>L</b> <b>i</b>	<b>Art.-No.</b>	
	mm mm mm info		
<b>M12x1.5</b>	18 9.5 8 1	<b>2450.12.32</b>	25
<b>M16x1.5</b>	18 9.5 8 1	<b>2450.17.32</b>	20
<b>M20x1.5</b>	22 10.0 8 2	<b>2450.20.32</b>	20
Auf Anfrage lieferbar: Für hohe Temperaturen (+200°C)	Available on request: For high temperature applications (+200°C)		



### Anschlussgewinde Pg | Entry thread Pg

Mit Sinterfilter Mit O-Ring	Sintered filter with O-ring		
<b>G</b>	 <b>H</b> <b>L</b> <b>i</b>	<b>Art.-No.</b>	
	mm mm mm info		
<b>Pg 7</b>	18 9.5 8 1	<b>2450.07.32</b>	25
<b>Pg 11</b>	22 10.0 8 2	<b>2450.11.32</b>	20
Auf Anfrage lieferbar: Für hohe Temperaturen (+200°C)	Available on request: For high temperature applications (+200°C)		



1  
2  
3  
4  
5  
6  
7  
8  
9  
10  
11  
12  
13  
14  
15

# Gegenmutter zu Entwässerungselement Lock nut for drainage element

## Anschlussgewinde metrisch | Entry thread metric

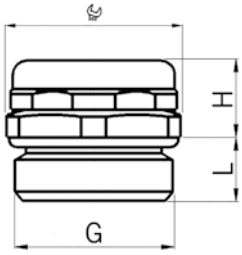



Material: Messing vernickelt  
 Sieb: Rostfreier Stahl A2  
 O-Ring: NBR  
 Schutzart: IP 4x  
 Einsatztemperatur: -50 °C / +110 °C

Material: Nickel-plated brass  
 Mesh: Stainless steel A2  
 O-ring: NBR  
 Protection class: IP 4x  
 Operation temperature: -50 °C / +110 °C



Mit Sieb  
 Mit O-Ring

with mesh  
 with O-ring

G	 mm	H mm	L mm	Art.-No.	
<b>M12x1.5</b>	18	9.5	10	<b>2450.12.36</b>	25
<b>M16x1.5</b>	18	9.5	10	<b>2450.17.36</b>	20
<b>M20x1.5</b>	22	10.0	10	<b>2450.20.36</b>	20

Auf Anfrage lieferbar:  
 Rostfreier Stahl A2 oder A4

Available on request:  
 Stainless steel A2 or A4

## Anschlussgewinde metrisch | Entry thread metric

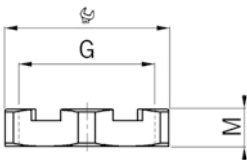



Material: Messing vernickelt  
 Einsatztemperatur: -50 °C / +200 °C

Material: Nickel-plated brass  
 Operation temperature: -50 °C / +200 °C



Zu Entwässerungselement

for drainage element

G	 mm	M mm	Art.-No.	
<b>M12x1.5</b>	15	4.5	<b>8324.12</b>	25
<b>M16x1.5</b>	19	5.5	<b>8324.17</b>	20
<b>M20x1.5</b>	24	5.5	<b>8324.20</b>	20



# Richtungsfeststeller Messing Adjustable fixing devices nickel-plated brass

## Kurzes Anschlussgewinde metrisch | Short entry thread metric

Material: Messing vernickelt  
 Dichtringe: NBR  
 Schutzart: IP 68  
 Eigenschaften: Universell verwendbar mit Kabel- oder Schlauchverschraubungen, gute Drehfreudigkeit durch spezielle Lagerung  
 Einsatztemperatur: -40 °C / +100 °C

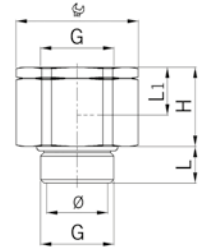
Material: Nickel-plated brass  
 Sealing rings: NBR  
 Protection class: IP 68  
 Properties: Multifunctional use in combination with cable- or conduit glands, smooth rotation due to a special bearing  
 Operation temperature: -40 °C / +100 °C



G		H	L	L1	Ø	Art.-No.	
	mm	mm	mm	mm	mm		
M16x1.5	24	20	10	12	11.0	2410.17	25
M20x1.5	30	22	10	13	15.5	2410.20	25
M25x1.5	36	24	11	13	20.5	2410.25	25
M32x1.5	46	27	13	14	28.0	2410.32	10
M40x1.5	55	28	13	15	35.0	2410.40	10
M50x1.5	65	32	14	16.5	43.0	2410.50	5

Achtung! Der Universal-Drehadapter kann kein Kugel- oder Wälzlager ersetzen!      Attention! The swivel adapter can not replace rolling- or ball bearings!





## Anschlussgewinde metrisch | Entry thread metric

Material: Messing vernickelt  
 O-Ring: 2 x NBR  
 Schutzart: IP 68  
 Einsatzbereich: Besonders geeignet für die richtungsstabile Montage von Winkeln  
 Einsatztemperatur: -40 °C / +100 °C

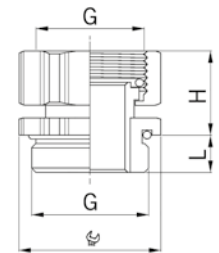
Material: Nickel-plated brass  
 O-ring: 2 x NBR  
 Protection class: IP 68  
 Application: Suitable for directionally stable mounting of elbows  
 Operation temperature: -40 °C / +100 °C



G		H	L	Art.-No.	
	mm	mm	mm		
M16x1.5	18	14	6	5000.17.50	50
M20x1.5	22	14	6.5	5000.20.50	50
M25x1.5	28	15	7	5000.25.50	50
M32x1.5	35	18	8	5000.32.50	50

Richtungsfeststeller Mit O-Ring      Adjustable fixing devices with O-ring



# Gegenmuttern Messing

## Lock nuts nickel-plated brass

### Anschlussgewinde metrisch | Entry thread metric

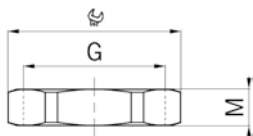



Material: Messing vernickelt  
 Ausführung: 6-kant  
 Einsatztemperatur: -60 °C / +200 °C

Material: Nickel-plated brass  
 Execution: Hexagonal design  
 Operation temperature: -60 °C / +200 °C



#### Gewinde metrisch

#### Metric thread

G	 mm	M mm	i info	Art.-No.	
M6x0.75	9	2.8	-	8000.06.1	50
M6x1.0	9	2.8	1	8000.06	50
M8x1.0	11	2.8	-	8000.08.1	50
M8x1.25	11	2.8	1	8000.08	50
M10x1.0	13	2.8	-	8000.10.1	50
M10x1.5	13	2.8	1	8000.10	50
M12x1.5	15	3.0	-	8000.12	100
M16x1.5	19	3.0	-	8000.17	100
M20x1.5	24	3.5	-	8000.20	100
M25x1.5	30	4.0	-	8000.25	50
M32x1.5	36	4.0	-	8000.32	25
M40x1.5	46	5.0	-	8000.40	25
M50x1.5	55	5.5	-	8000.50	10
M63x1.5	70	6.0	-	8000.63	10
M75x1.5	80	6.0	-	8000.75	10
M80x2.0	95	8.0	-	8000.080	5
M85x2.0	95	8.0	-	8000.085	5
M95x2.0	110	9.0	-	8000.095	5
M100x3.0	115	9.0	-	8000.100	1
M105x3.0	120	9.0	-	8000.105	1
M115x3.0	125	10.0	-	8000.115	1

1 = Metrisches Regelgewinde

1 = Metric coarse-pitch thread

### Anschlussgewinde Pg | Entry thread Pg



#### Gewinde Pg

#### Pg thread

G	 mm	M mm	Art.-No.	
Pg 7	15	3.0	8007	50
Pg 9	18	3.0	8009	50
Pg 11	21	3.0	8011	50
Pg 13	23	3.0	8013	50
Pg 16	26	3.0	8016	50
Pg 21	32	3.5	8021	25
Pg 29	41	4.0	8029	10
Pg 36	51	5.0	8036	10
Pg 42	60	5.0	8042	10
Pg 48	65	5.5	8048.48	10

# Gegenmuttern Messing, dicke Ausführung Lock nuts nickel-plated brass, thick-walled version

## Anschlussgewinde Gasrohr | Gas-pipe entry thread

Material: Messing vernickelt  
Ausführung: 6-kant  
Einsatztemperatur: -60 °C / +200 °C

Material: Nickel-plated brass  
Execution: Hexagonal design  
Operation temperature: -60 °C / +200 °C

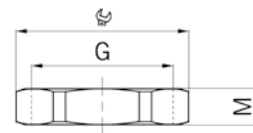

### Gasrohr-Gewinde

### Gas-pipe thread

G	 mm	M mm	i info	Art.-No.	
G 3/8"	19	3.0	-	803/8G	10
G 1/2"	24	3.0	-	801/2G	10
G 5/8"	26	3.0	-	805/8G	10
G 3/4"	30	3.5	-	803/4G	10
G 1"	38	4.5	-	801G	10
G 1 1/2"	51	5.0	-	8011/2G	10
G 1 1/4"	46	5.0	-	8011/4G	10
G 2"	65	5.5	-	8048	5
G 2 1/2"	90	12.0	1	8050	5
G 3"	105	12.0	1	8051	5

1 = Runde Bauform, Stahl verzinkt

1 = Round form, zinc coated steel



## Anschlussgewinde metrisch | Entry thread metric

### Dicke Ausführung

### Thick-walled version

G	 mm	M mm	Art.-No.	
M12x1.5	15	5.0	8300.12	50
M16x1.5	19	5.0	8300.17	50
M20x1.5	24	5.5	8300.20	50
M25x1.5	30	5.5	8300.25	50
M32x1.5	36	6.0	8300.32	50
M40x1.5	46	7.0	8300.40	50



## Anschlussgewinde Pg | Entry thread Pg

### Dicke Ausführung

### Thick-walled version

G	 mm	M mm	Art.-No.	
Pg 7	15	5.0	8300.07	50
Pg 9	18	5.0	8300.09	50
Pg 11	21	5.0	8300.11	50
Pg 13	24	5.5	8300.13	50
Pg 16	26	5.5	8300.16	50
Pg 21	32	6.0	8300.21	50
Pg 29	41	7.0	8300.29	50



# Gegenmuttern Messing mit Hinterstich für O-Ring

## Lock nuts nickel-plated brass with recess for O-ring

### Anschlussgewinde metrisch | Entry thread metric

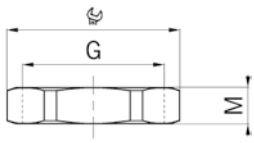

Material: Messing vernickelt  
 Ausführung: 6-kant  
 O-Ring: Separat bestellen  
 Einsatztemperatur: -60 °C / +200 °C

Material: Nickel-plated brass  
 Execution: Hexagonal design  
 O-ring: To be ordered separately  
 Operation temperature: -60 °C / +200 °C



Dicke Ausführung  
 Ohne O-Ring

Thick-walled version  
 without O-Ring

G	 mm	M mm	O-ring	Art.-No.	
<b>M12x1.5</b>	15	5.0	1007.00.08	<b>8300.12.1</b>	50
<b>M16x1.5</b>	19	5.0	1016.00.15.08	<b>8300.17.1</b>	50
<b>M20x1.5</b>	24	5.5	1016.00.08	<b>8300.20.1</b>	50
<b>M25x1.5</b>	30	5.5	1013.00.22.08	<b>8300.25.1</b>	50
<b>M32x1.5</b>	36	6.0	1021.00.30.08	<b>8300.32.1</b>	50
<b>M40x1.5</b>	46	7.0	1029.00.39.08	<b>8300.40.1</b>	50
<b>M50x1.5</b>	55	7.5	1036.00.49.08	<b>8300.50.1</b>	10
<b>M63x1.5</b>	70	8.0	1048.00.62.08	<b>8300.63.1</b>	10

### Rostfreier Stahl A2 | Stainless steel A2

Material: Rostfreier CrNi-Stahl A2  
(DIN EN 1.4305 / AISI 303)

Ausführung: 6-kant



Einsatztemperatur: -60 °C / +300 °C

Material: CrNi stainless steel A2  
(DIN EN 1.4305 / AISI 303)

Execution: Hexagonal design

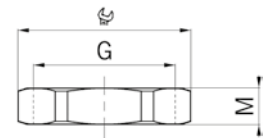

Operation temperature: -60 °C / +300 °C



Gewinde metrisch				Metric thread		
G	 mm	M mm	i info	Art.-No.		
M8x1.25	11	2.8	1	8008.96	50	
M10x1.5	13	2.8	1	8010.96	50	
M12x1.5	17	3.0	-	8012.96	50	
M16x1.5	19	3.0	-	8017.96	50	
M20x1.5	24	3.5	-	8020.96	50	
M25x1.5	30	3.5	-	8025.96	25	
M32x1.5	36	4.5	-	8032.96	25	
M40x1.5	46	4.5	-	8040.96	10	
M50x1.5	55	5.5	-	8050.96	10	
M63x1.5	70	6.0	-	8063.96	5	

1 = Metrisches Regelgewinde      1 = Metric coarse-pitch thread



Gewinde Pg			Pg thread		
G	 mm	M mm	Art.-No.		
Pg 7	17	3.5	8007.96	50	
Pg 9	19	3.5	8009.96	50	
Pg 11	22	3.5	8011.96	50	
Pg 13	24	4.0	8013.96	50	
Pg 16	27	4.0	8016.96	50	
Pg 21	32	4.5	8021.96	25	
Pg 29	41	5.5	8029.96	10	
Pg 36	51	6.0	8036.96	10	

1  
2  
3  
4  
5  
6  
7  
8  
9  
10  
11  
12  
13  
14  
15

# Gegenmuttern rostfreier Stahl

## Stainless steel lock nuts

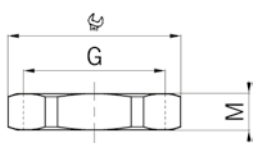

### Rostfreier und säurebeständiger Stahl A4 | Stainless steel and acid resistant steel A4



Material: Rostfreier und säurebeständiger CrNiMo-Stahl A4 (DIN EN 1.4435 / AISI 316L)  
 Ausführung: 6-kant  
 Einsatztemperatur: -60 °C / +300 °C

Material: Stainless steel and acid resistant steel A4 CrNiMo (DIN EN 1.4435 / AISI 316L)  
 Execution: Hexagonal design  
 Operation temperature: -60 °C / +300 °C



Gewinde metrisch				Metric thread		
G	 mm	M mm	i info	Art.-No.		
M8x1.25	11	2.8	1	8008.98	50	
M10x1.5	13	2.8	1	8010.98	50	
M12x1.5	17	3.0	-	8012.98	50	
M16x1.5	19	3.0	-	8017.98	50	
M20x1.5	24	3.5	-	8020.98	50	
M25x1.5	30	3.5	-	8025.98	25	
M32x1.5	36	4.5	-	8032.98	25	
M40x1.5	46	4.5	-	8040.98	10	
M50x1.5	55	5.5	-	8050.98	10	
M63x1.5	70	6.0	-	8063.98	5	



1 = Metrisches Regelgewinde                      1 = Metric coarse-pitch thread

### Anschlussgewinde metrisch | Entry thread metric

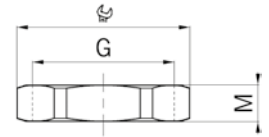

Material: Polyamid  
glasfaserverstärkt  
Eigenschaften: halogenfrei  
Ausführung: 6-kant  
Einsatztemperatur: -40 °C / +100 °C

Material: Polyamide  
glass fiber reinforced  
Properties: halogen-free  
Execution: Hexagonal design  
Operation temperature: -40 °C / +100 °C



Hellgrau RAL 7035			Light grey RAL 7035		
G	 mm	M	Art.-No.		
M12x1.5	17	5.5	8212	100	
M16x1.5	22	5.5	8217	100	
M20x1.5	26	6.5	8220	100	
M25x1.5	32	7.0	8225	100	
M32x1.5	41	7.0	8232	100	
M40x1.5	50	7.0	8240	50	
M50x1.5	60	8.5	8250	10	



Schwarz RAL 9005			Black RAL 9005		
G	 mm	M	Art.-No.		
M12x1.5	17	5.5	8212.40	100	
M16x1.5	22	5.5	8217.40	100	
M20x1.5	26	6.5	8220.40	100	
M25x1.5	32	7.0	8225.40	100	
M32x1.5	41	7.0	8232.40	100	
M40x1.5	50	7.0	8240.40	50	
M50x1.5	60	8.5	8250.40	10	



# Gegenmutter Kunststoff

## Synthetic lock nuts

### Anschlussgewinde Pg | Entry thread Pg

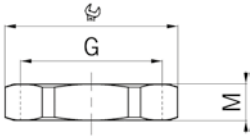

Material: Polyamid glasfaserverstärkt

Eigenschaften: halogenfrei

Ausführung: 6-kant

Einsatztemperatur: -40 °C / +100 °C

Material: Polyamide

Properties: glass fiber reinforced

Execution: halogen-free

Operation temperature: Hexagonal design -40 °C / +100 °C

Polyamide  
glass fiber reinforced

halogen-free

Hexagonal design

-40 °C / +100 °C



Hellgrau RAL 7035

Light grey RAL 7035

G	 mm	M	Art.-No.	
Pg 7	19	5.0	8207	100
Pg 9	22	6.0	8209	100
Pg 11	24	6.0	8211	100
Pg 13	27	6.0	8213	100
Pg 16	30	6.0	8216	100
Pg 21	36	7.0	8221	100
Pg 29	46	7.0	8229	50
Pg 36	60	8.0	8236	25
Pg 42	65	8.0	8242	25
Pg 48	70	8.0	8248.48	25



Schwarz RAL 9005

Black RAL 9005

G	 mm	M	Art.-No.	
Pg 7	19	5.0	8207.40	100
Pg 9	22	6.0	8209.40	100
Pg 11	24	6.0	8211.40	100
Pg 13	27	6.0	8213.40	100
Pg 16	30	6.0	8216.40	100
Pg 21	36	7.0	8221.40	100
Pg 29	46	7.0	8229.40	50
Pg 36	60	8.0	8236.40	25
Pg 42	65	8.0	8242.40	25
Pg 48	70	8.0	8248.48.40	25

# Gegenmutter Kunststoff mit Flansch



## Synthetic lock nuts with flange

### Anschlussgewinde metrisch | Entry thread metric

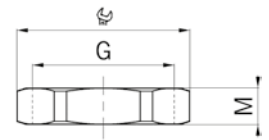

Material: Polyamid PA 6  
 Eigenschaften: halogenfrei  
 Ausführung: 6-kant mit Flansch  
 Einsatztemperatur: -30 °C / +100 °C

Material: Polyamide PA 6  
 Properties: halogen-free  
 Execution: Hexagonal design with flange  
 Operation temperature: -30 °C / +100 °C



Hellgrau RAL 7035			Light grey RAL 7035		
G	 mm	M	Art.-No.		
M12x1.5	17	5.0	8255.12	100	
M16x1.5	22	5.0	8255.17	100	
M20x1.5	27	6.0	8255.20	100	
M25x1.5	33	6.7	8255.25	100	
M32x1.5	42	7.9	8255.32	50	
M40x1.5	48	8.4	8255.40	50	
M50x1.5	59	9.9	8255.50	10	
M63x1.5	73	11.0	8255.63	10	



Schwarz RAL 9005			Black RAL 9005		
G	 mm	M	Art.-No.		
M12x1.5	17	5.0	8245.12	100	
M16x1.5	22	5.0	8245.17	100	
M20x1.5	27	6.0	8245.20	100	
M25x1.5	33	6.7	8245.25	100	
M32x1.5	42	7.9	8245.32	50	
M40x1.5	48	8.4	8245.40	50	
M50x1.5	59	9.9	8245.50	10	
M63x1.5	73	11.0	8245.63	10	



# Gegenmuttern Kunststoff mit Flansch

## Synthetic lock nuts with flange

### Anschlussgewinde Pg | Entry thread Pg

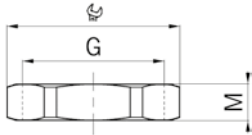

Material: Polyamid PA 6  
 Eigenschaften: halogenfrei  
 Ausführung: 6-kant mit Flansch  
 Einsatztemperatur: -30 °C / +100 °C

Material: Polyamide PA 6  
 Properties: halogen-free  
 Execution: Hexagonal design with flange  
 Operation temperature: -30 °C / +100 °C



Hellgrau RAL 7035

Light grey RAL 7035

G	 mm	M	Art.-No.	
<b>Pg 7</b>	19	5.0	<b>8255.07</b>	100
<b>Pg 9</b>	21	5.0	<b>8255.09</b>	100
<b>Pg 11</b>	24	5.0	<b>8255.11</b>	100
<b>Pg 13</b>	27	6.0	<b>8255.13</b>	100
<b>Pg 16</b>	30	6.0	<b>8255.16</b>	100
<b>Pg 21</b>	36	7.0	<b>8255.21</b>	50
<b>Pg 29</b>	46	8.0	<b>8255.29</b>	50
<b>Pg 36</b>	59	8.0	<b>8255.36</b>	25
<b>Pg 42</b>	65	8.0	<b>8255.42</b>	10
<b>Pg 48</b>	69	8.0	<b>8255.48</b>	10



Schwarz RAL 9005

Black RAL 9005

G	 mm	M	Art.-No.	
<b>Pg 7</b>	19	5.0	<b>8245.07</b>	100
<b>Pg 9</b>	21	5.0	<b>8245.09</b>	100
<b>Pg 11</b>	24	5.0	<b>8245.11</b>	100
<b>Pg 13</b>	27	6.0	<b>8245.13</b>	100
<b>Pg 16</b>	30	6.0	<b>8245.16</b>	100
<b>Pg 21</b>	36	7.0	<b>8245.21</b>	50
<b>Pg 29</b>	46	8.0	<b>8245.29</b>	50
<b>Pg 36</b>	59	8.0	<b>8245.36</b>	25
<b>Pg 42</b>	65	8.0	<b>8245.42</b>	10
<b>Pg 48</b>	69	8.0	<b>8245.48</b>	10

### Anschlussgewinde metrisch | Entry thread metric

Material: Polyamid PA 6  
 Eigenschaften: halogenfrei  
 Ausführung: 6-kant  
 Einsatztemperatur: -50 °C / +105 °C

Material: Polyamide PA 6  
 Properties: halogen-free  
 Execution: Hexagonal design  
 Operation temperature: -50 °C / +105 °C

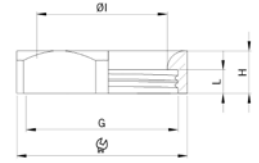

Schwarz RAL 9005  
 Verhindert den Abrieb des Kabelmantels  
 Teilbar für die nachträgliche Montage

Black RAL 9005  
 Prevents abrasion of the cable sheath  
 Divisible for retrofitting

G	 mm	L mm	H mm	ØI mm	Art.-No.	
M16x1.5	22	5	9	12	8200.17.45	50
M20x1.5	24	5	9	16	8200.20.45	50
M25x1.5	30	5	9	21	8200.25.45	50
M32x1.5	36	5	9	27.5	8200.32.45	25
M40x1.5	46	5	10	35	8200.40.45	25
M50x1.5	55	5	10	45	8200.50.45	10
M63x1.5	70	5	12	55.5	8200.63.45	10



EN 45545-2  
 HL 3

# Reduktionen Messing

## Reduction fittings nickel-plated brass

mit 6-kant | hexagonal

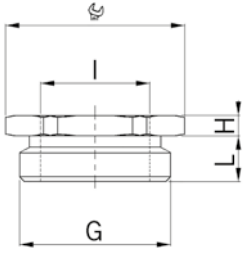



Material: Messing vernickelt  
 O-Ring: NBR  
 Schutzart: IP 68  
 Einsatztemperatur: -40 °C / +100 °C

Material: Nickel-plated brass  
 O-ring: NBR  
 Protection class: IP 68  
 Operation temperature: -40 °C / +100 °C



Aussengewinde metrisch  
 Innengewinde metrisch  
 Mit O-Ring

Outer thread metric  
 Inner thread metric  
 with O-ring

G	I	 mm	H mm	L mm	i info	Art.-No.	
M 8x1.25	M 6x1.0	11	8.0	5	1	3500.08.06	50
M 10x1.5	M 6x1.0	13	3.0	5	1	3500.10.06	50
M 10x1.5	M 8x1.25	13	8.0	5	1	3500.10.08	50
M 12x1.5	M 8x1.25	15	3.0	5	1	3500.12.08	50
M 12x1.5	M 10x1.5	15	8.0	5	1	3500.12.10	50
M 16x1.5	M 10x1.5	18	3.0	5	1	3500.17.10	50
M 16x1.5	M 12x1.5	18	3.0	5	-	3500.17.12	50
M 20x1.5	M 12x1.5	24	3.0	6	-	3500.20.12	50
M 20x1.5	M 16x1.5	24	3.0	6	-	3500.20.17	50
M 25x1.5	M 16x1.5	30	3.5	7	-	3500.25.17	25
M 25x1.5	M 20x1.5	30	3.5	7	-	3500.25.20	25
M 32x1.5	M 20x1.5	36	4.0	8	-	3500.32.20	20
M 32x1.5	M 25x1.5	36	4.0	8	-	3500.32.25	20
M 40x1.5	M 25x1.5	46	4.5	8	-	3500.40.25	10
M 40x1.5	M 32x1.5	46	4.5	8	-	3500.40.32	10
M 50x1.5	M 32x1.5	55	5.0	9	-	3500.50.32	10
M 50x1.5	M 40x1.5	55	5.0	9	-	3500.50.40	10
M 63x1.5	M 40x1.5	70	5.5	10	-	3500.63.40	5
M 63x1.5	M 50x1.5	70	5.5	10	-	3500.63.50	5
M 75x1.5	M 50x1.5	80	6.0	11	-	3500.75.50	5
M 75x1.5	M 63x1.5	80	6.0	11	-	3500.75.63	5

1 = Metrisches Regelgewinde

1 = Metric coarse-pitch thread

## Runde Bauform, randriert | Round, knurled

Material: Messing vernickelt  
Schutzart: IP 54  
Gewinde: IP 68, wenn Anschlussge-  
winde abgedichtet  
Einsatztemperatur: -40 °C / +200 °C

Material: Nickel-plated brass  
Protection class: IP 54  
Entry thread: IP 68, if the entry thread  
is sealed  
Operation temperature: -40 °C / +200 °C

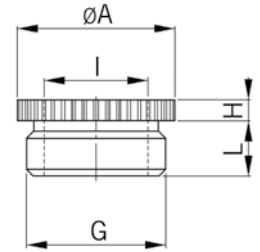

Aussengewinde metrisch  
Innengewinde metrisch  
Ohne O-Ring

Outer thread metric  
Inner thread metric  
without O-Ring

G	I	øA	H	L	Art.-No.	
		mm	mm	mm		
M16x1.5	M12x1.5	18	3	7	3545.17.12	100
M20x1.5	M12x1.5	22	3	8	3545.20.12	100
M20x1.5	M16x1.5	22	3	8	3545.20.17	100
M25x1.5	M16x1.5	27	3	8	3545.25.17	50
M25x1.5	M20x1.5	27	3	8	3545.25.20	50
M32x1.5	M20x1.5	34	4	9	3545.32.20	50
M32x1.5	M25x1.5	34	4	9	3545.32.25	50
M40x1.5	M25x1.5	42	4.5	9	3545.40.25	50
M40x1.5	M32x1.5	42	4.5	9	3545.40.32	25
M50x1.5	M32x1.5	52	4.5	10	3545.50.32	25
M50x1.5	M40x1.5	52	4.5	10	3545.50.40	10
M63x1.5	M40x1.5	65	5	11	3545.63.40	10
M63x1.5	M50x1.5	65	5	11	3545.63.50	10

## mit 6-kant | hexagonal

Material: Messing vernickelt  
O-Ring: NBR  
Schutzart: IP 68  
Einsatztemperatur: -40 °C / +100 °C

Material: Nickel-plated brass  
O-ring: NBR  
Protection class: IP 68  
Operation temperature: -40 °C / +100 °C

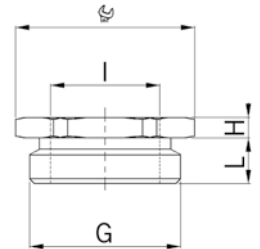

Aussengewinde Pg  
Innengewinde Pg  
Mit O-Ring

Outer thread Pg  
Inner thread Pg  
with O-ring

G	I	øA	H	L	Art.-No.	
		mm	mm	mm		
Pg 9	Pg 7	18	3.0	6.5	3509.07	50
Pg 11	Pg 7	20	3.0	6.5	3511.07	50
Pg 11	Pg 9	22	3.0	7.0	3511.09	50
Pg 13	Pg 7	24	3.0	7.0	3513.07	50
Pg 13	Pg 9	24	3.0	7.0	3513.09	50
Pg 13	Pg 11	24	3.0	7.0	3513.11	50
Pg 16	Pg 9	24	3.0	7.0	3516.09	50
Pg 16	Pg 11	24	3.0	7.0	3516.11	50
Pg 16	Pg 13	27	3.0	7.0	3516.13	50
Pg 21	Pg 11	32	3.5	7.5	3521.11	25
Pg 21	Pg 13	32	3.5	7.5	3521.13	25
Pg 21	Pg 16	32	3.5	7.5	3521.16	25
Pg 29	Pg 13	38	4.0	8.0	3529.13	10
Pg 29	Pg 16	38	4.0	8.0	3529.16	10
Pg 29	Pg 21	38	4.0	8.0	3529.21	10
Pg 36	Pg 21	50	4.5	8.5	3536.21	10
Pg 36	Pg 29	50	4.5	8.5	3536.29	10
Pg 42	Pg 29	60	4.0	11.0	3542.29	10
Pg 42	Pg 36	60	4.0	11.0	3542.36	10
Pg 48	Pg 36	65	4.0	11.0	3548.48.36	10

1  
2  
3  
4  
5  
6  
7  
8  
9  
10  
11  
12  
13  
14  
15

# Erweiterungen Messing

## Enlarging fittings nickel-plated brass

### mit 6-kant | hexagonal

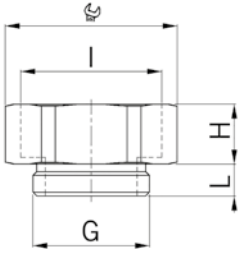



Material: Messing vernickelt  
 O-Ring: NBR  
 Schutzart: IP 68  
 Einsatztemperatur: -40 °C / +100 °C

Material: Nickel-plated brass  
 O-ring: NBR  
 Protection class: IP 68  
 Operation temperature: -40 °C / +100 °C



Aussengewinde metrisch  
 Innengewinde metrisch  
 Mit O-Ring

Outer thread metric  
 Inner thread metric  
 with O-ring

G	I	 mm	H mm	L mm	i info	Art.-No.	
M 6x1.0	M 8x1.25	11	8.5	5	1	3600.06.08	50
M 6x1.0	M 10x1.5	13	8.5	5	1	3600.06.10	50
M 8x1.25	M 10x1.5	13	9	5	1	3600.08.10	50
M 8x1.25	M 12x1.5	15	9	5	1	3600.08.12	50
M 10x1.5	M 12x1.5	15	9	5	1	3600.10.12	50
M 10x1.5	M 16x1.5	18	9	5	1	3600.10.17	50
M 12x1.5	M 16x1.5	18	9	5	-	3600.12.17	50
M 12x1.5	M 20x1.5	24	10	5	-	3600.12.20	50
M 16x1.5	M 20x1.5	24	10	5	-	3600.17.20	50
M 20x1.5	M 25x1.5	30	11.5	6	-	3600.20.25	25
M 25x1.5	M 32x1.5	36	14	7	-	3600.25.32	25
M 32x1.5	M 40x1.5	46	14	8	-	3600.32.40	25
M 40x1.5	M 50x1.5	55	16	8	-	3600.40.50	10
M 50x1.5	M 63x1.5	70	17	9	-	3600.50.63	10
M 63x1.5	M 75x1.5	80	18	10	-	3600.63.75	10

1 = Metrisches Regelgewinde

1 = Metric coarse-pitch thread

### Runde Bauform | Round execution

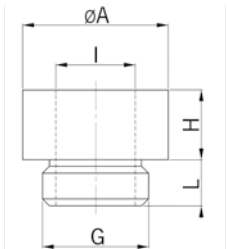

Material: Messing vernickelt  
 Schutzart: IP 54  
 Gewinde: IP 68, wenn Anschlussge-  
 winde abgedichtet  
 Einsatztemperatur: -40 °C / +200 °C

Material: Nickel-plated brass  
 Protection class: IP 54  
 Entry thread: IP 68, if the entry thread  
 is sealed  
 Operation temperature: -40 °C / +200 °C



Aussengewinde metrisch  
 Innengewinde metrisch  
 Ohne O-Ring

Outer thread metric  
 Inner thread metric  
 without O-Ring

G	I	ØA mm	H mm	L mm	Art.-No.	
M 12x1.5	M 16x1.5	19	9.5	6.5	3645.12.17	100
M 16x1.5	M 20x1.5	22	10.5	7	3645.17.20	100
M 20x1.5	M 25x1.5	27	11	8	3645.20.25	100
M 25x1.5	M 32x1.5	34	12	8	3645.25.32	50
M 32x1.5	M 40x1.5	42	12	9	3645.32.40	50
M 40x1.5	M 50x1.5	53	14	9	3645.40.50	25
M 50x1.5	M 63x1.5	66	19	10	3645.50.63	25

mit 6-kant | hexagonal

Material: Messing vernickelt  
O-Ring: NBR  
Schutzart: IP 68  
Einsatztemperatur: -40 °C / +100 °C

Material: Nickel-plated brass  
O-ring: NBR  
Protection class: IP 68  
Operation temperature: -40 °C / +100 °C

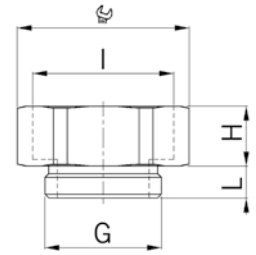

Aussengewinde Pg  
Innengewinde Pg  
Mit O-Ring

Outer thread Pg  
Inner thread Pg  
with O-ring

G	I	 mm	H mm	L mm	Art.-No.	
<b>Pg 7</b>	Pg 9	18	13	8	<b>3607.09.08</b>	50
<b>Pg 9</b>	Pg 11	22	15	8	<b>3609.11.08</b>	50
<b>Pg 9</b>	Pg 13	24	15	8	<b>3609.13.08</b>	50
<b>Pg 11</b>	Pg 13	24	15	8	<b>3611.13.08</b>	50
<b>Pg 11</b>	Pg 16	24	15	8	<b>3611.16.08</b>	50
<b>Pg 11</b>	Pg 21	32	16	8	<b>3611.21.08</b>	50
<b>Pg 13</b>	Pg 16	24	15	8	<b>3613.16.08</b>	50
<b>Pg 13</b>	Pg 21	32	16	8	<b>3613.21.08</b>	25
<b>Pg 16</b>	Pg 21	32	16	8	<b>3616.21.08</b>	25
<b>Pg 16</b>	Pg 29	40	16	8	<b>3616.29.08</b>	25
<b>Pg 21</b>	Pg 29	40	16	8	<b>3621.29.08</b>	25
<b>Pg 29</b>	Pg 36	50	18	10	<b>3629.36.08</b>	20
<b>Pg 36</b>	Pg 42	60	19	12	<b>3636.42.08</b>	10
<b>Pg 36</b>	Pg 48	64	20	12	<b>3636.48.48.08</b>	10

# Adapter Messing

## Adapter nickel-plated brass

mit 6-kant | hexagonal

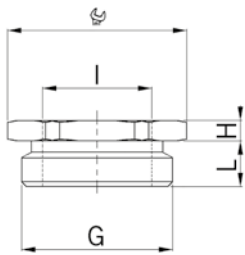

Material: Messing vernickelt  
 O-Ring: NBR  
 Schutzart: IP 68  
 Einsatztemperatur: -40 °C / +100 °C

Material: Nickel-plated brass  
 O-ring: NBR  
 Protection class: IP 68  
 Operation temperature: -40 °C / +100 °C



Aussengewinde metrisch  
 Innengewinde Pg  
 Mit O-Ring

Outer thread metric  
 Inner thread Pg  
 with O-ring

G	I	 mm	H mm	L mm	Art.-No.	
M16x1.5	Pg 7	20	3.0	5	3500.17.07	50
M20x1.5	Pg 7	24	3.0	6	3500.20.07	50
M20x1.5	Pg 9	24	3.0	6	3500.20.09	50
M20x1.5	Pg 11	24	10.0	6	3500.20.11	50
M25x1.5	Pg 9	30	3.5	7	3500.25.09	50
M25x1.5	Pg 11	30	3.5	7	3500.25.11	50
M25x1.5	Pg 13	30	3.8	7	3500.25.13	50
M25x1.5	Pg 16	30	15.0	7	3500.25.16	25
M32x1.5	Pg 21	38	16.0	8	3500.32.21	25
M40x1.5	Pg 29	45	16.0	8	3500.40.29	10
M50x1.5	Pg 29	55	4.0	9	3500.50.29	10
M63x1.5	Pg 36	70	5.5	10	3500.63.36	10



Aussengewinde metrisch  
 Innengewinde Pg  
 Mit O-Ring

Outer thread metric  
 Inner thread Pg  
 with O-ring

G	I	 mm	H mm	L mm	i info	Art.-No.	
M10x1.5	Pg 7	16	12	5	1	3600.10.07	50
M10x1.5	Pg 9	18	12	5	1	3600.10.09	50
M12x1.5	Pg 9	18	12	5	-	3600.12.09	50
M16x1.5	Pg 11	22	14	5	-	3600.17.11	50
M20x1.5	Pg 13	24	15	6	-	3600.20.13	50
M20x1.5	Pg 16	24	15	6	-	3600.20.16	50
M25x1.5	Pg 21	32	16	7	-	3600.25.21	25
M32x1.5	Pg 29	40	16	8	-	3600.32.29	25
M40x1.5	Pg 36	50	18	8	-	3600.40.36	20
M50x1.5	Pg 42	60	19	9	-	3600.50.42	10
M50x1.5	Pg 48	64	20	9	-	3600.50.48	10

1 = Metrisches Regelgewinde

1 = Metric coarse-pitch thread

mit 6-kant | hexagonal

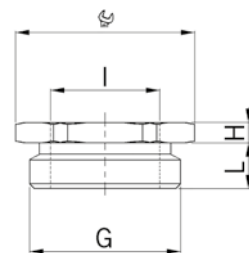

Material: Messing vernickelt  
O-Ring: NBR  
Schutzart: IP 68  
Einsatztemperatur: -40 °C / +100 °C

Material: Nickel-plated brass  
O-ring: NBR  
Protection class: IP 68  
Operation temperature: -40 °C / +100 °C



Aussengewinde Pg  
Innengewinde metrisch  
Mit O-Ring

Outer thread Pg  
Inner thread metric  
with O-ring

G	I	 mm	H mm	L mm	i info	Art.-No.	
Pg 7	M 6x1.0	15	3.0	6	1	3500.07.06	50
Pg 7	M 8x1.25	15	3.0	6	1	3500.07.08	50
Pg 7	M 10x1.5	15	7.0	6	1	3500.07.10	50
Pg 9	M 6x1.0	18	3.0	6	1	3500.09.06	50
Pg 9	M 8x1.25	18	3.0	6	1	3500.09.08	50
Pg 9	M 10x1.5	18	3.0	6	1	3500.09.10	50
Pg 9	M 12x1.5	18	8.0	6	-	3500.09.12	50
Pg 11	M 6x1.0	21	3.0	6	1	3500.11.06	50
Pg 11	M 8x1.25	21	3.0	6	1	3500.11.08	50
Pg 11	M 10x1.5	21	3.0	6	1	3500.11.10	50
Pg 11	M 12x1.5	21	3.0	6	-	3500.11.12	50
Pg 11	M 16x1.5	21	8.0	6	-	3500.11.17	50
Pg 13	M 12x1.5	24	3.0	6	-	3500.13.12	50
Pg 13	M 16x1.5	24	3.0	6	-	3500.13.17	50
Pg 16	M 12x1.5	24	3.0	6	-	3500.16.12	25
Pg 16	M 16x1.5	24	3.0	6	-	3500.16.17	25
Pg 16	M 20x1.5	24	10.5	6	-	3500.16.20	25
Pg 21	M 16x1.5	30	3.5	7.5	-	3500.21.17	25
Pg 21	M 20x1.5	30	3.5	7.5	-	3500.21.20	25
Pg 21	M 25x1.5	30	10.5	7.5	-	3500.21.25	25
Pg 29	M 25x1.5	38	4.0	8	-	3500.29.25	20
Pg 29	M 32x1.5	38	13.0	8	-	3500.29.32	20
Pg 36	M 32x1.5	50	4.5	8	-	3500.36.32	10
Pg 36	M 40x1.5	50	4.5	8	-	3500.36.40	10
Pg 42	M 32x1.5	55	5.0	10	-	3500.42.32	10
Pg 42	M 40x1.5	55	5.0	10	-	3500.42.40	10
Pg 42	M 50x1.5	55	15.0	10	-	3500.42.50	10
Pg 48	M 40x1.5	65	5.5	11	-	3500.48.40	5
Pg 48	M 50x1.5	65	5.5	11	-	3500.48.50	5

1 = Metrisches Regelgewinde

1 = Metric coarse-pitch thread

# Adapter Messing

## Adapter nickel-plated brass

mit 6-kant | hexagonal

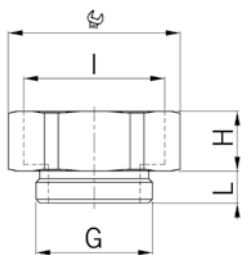



Material: Messing vernickelt  
 O-Ring: NBR  
 Schutzart: IP 68  
 Einsatztemperatur: -40 °C / +100 °C

Material: Nickel-plated brass  
 O-ring: NBR  
 Protection class: IP 68  
 Operation temperature: -40 °C / +100 °C



Aussengewinde Pg  
 Innengewinde metrisch  
 Mit O-Ring

Outer thread Pg  
 Inner thread metric  
 with O-ring

G	I	 mm	H mm	L mm	Art.-No.	
Pg 7	M12x1.5	15	9.0	6	3600.07.12	50
Pg 7	M16x1.5	18	9.0	6	3600.07.17	50
Pg 9	M16x1.5	18	9.5	6	3600.09.17	50
Pg 9	M20x1.5	24	10.5	6	3600.09.20	50
Pg 11	M20x1.5	24	10.5	6	3600.11.20	50
Pg 11	M25x1.5	30	11.5	6	3600.11.25	25
Pg 13	M20x1.5	24	10.5	6	3600.13.20	50
Pg 13	M25x1.5	30	11.5	6	3600.13.25	25
Pg 16	M25x1.5	30	11.5	6	3600.16.25	25
Pg 16	M32x1.5	36	13.5	6	3600.16.32	25
Pg 21	M32x1.5	36	14.0	7.5	3600.21.32	25
Pg 21	M40x1.5	46	14.0	7.5	3600.21.40	20
Pg 29	M40x1.5	46	14.0	8	3600.29.40	20
Pg 29	M50x1.5	55	16.0	8	3600.29.50	10
Pg 36	M50x1.5	55	16.0	8	3600.36.50	10
Pg 36	M63x1.5	70	17.0	8	3600.36.63	10
Pg 42	M63x1.5	70	17.0	10	3600.42.63	10
Pg 42	M75x1.5	80	18.0	10	3600.42.75	10
Pg 48	M63x1.5	70	17.0	11	3600.48.63	10
Pg 48	M75x1.5	80	18.0	11	3600.48.75	10

## Runde Bauform, randriert | Round, knurled

Material: Messing vernickelt  
Schutzart: IP 54  
Gewinde: IP 68, wenn Anschlussge-  
winde abgedichtet  
Einsatztemperatur: -40 °C / +200 °C

Material: Nickel-plated brass  
Protection class: IP 54  
Entry thread: IP 68, if the entry thread  
is sealed  
Operation temperature: -40 °C / +200 °C

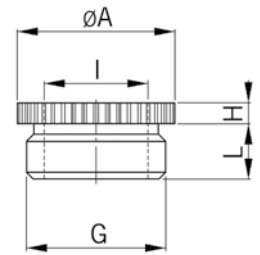

Aussengewinde Pg  
Innengewinde metrisch  
Ohne O-Ring

Outer thread Pg  
Inner thread metric  
without O-Ring

G	I	øA mm	H mm	L mm	Art.-No.	
Pg 11	M16x1.5	20	10	6	3545.11.17	50
Pg 16	M20x1.5	24	11	6	3545.16.20	50
Pg 21	M20x1.5	30	3.5	7.5	3545.21.20	50
Pg 21	M25x1.5	30	11	7.5	3545.21.25	50
Pg 29	M25x1.5	39	4	8	3545.29.25	25
Pg 29	M32x1.5	39	4	8	3545.29.32	25
Pg 36	M40x1.5	50	4.5	8	3545.36.40	10



## Runde Bauform | Round execution

Material: Messing vernickelt  
Schutzart: IP 54  
Gewinde: IP 68, wenn Anschlussge-  
winde abgedichtet  
Einsatztemperatur: -40 °C / +200 °C

Material: Nickel-plated brass  
Protection class: IP 54  
Entry thread: IP 68, if the entry thread  
is sealed  
Operation temperature: -40 °C / +200 °C

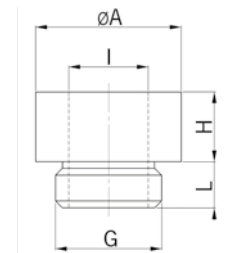

Aussengewinde Pg  
Innengewinde metrisch  
Ohne O-Ring

Outer thread Pg  
Inner thread metric  
without O-Ring

G	I	øA mm	H mm	L mm	Art.-No.	
Pg 7	M12x1.5	14	9	6	3645.07.12	100
Pg 9	M16x1.5	19	9.5	6	3645.09.17	50
Pg 11	M20x1.5	22	11	6	3645.11.20	50
Pg 13	M20x1.5	22	11	6	3645.13.20	50
Pg 16	M25x1.5	27	11	6	3645.16.25	50
Pg 21	M32x1.5	34	12	7.5	3645.21.32	50
Pg 29	M40x1.5	42	12	8	3645.29.40	10



# Adapter Messing

## Adapter nickel-plated brass

mit 6-kant | hexagonal

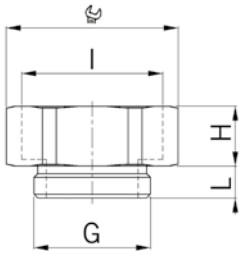

Material: Messing vernickelt  
 O-Ring: NBR  
 Schutzart: IP 68  
 Einsatztemperatur: -40 °C / +100 °C

Material: Nickel-plated brass  
 O-ring: NBR  
 Protection class: IP 68  
 Operation temperature: -40 °C / +100 °C



Aussengewinde Pg  
 Innengewinde Gasrohr  
 Mit O-Ring

Outer thread Pg  
 Inner thread gas-pipe  
 with O-ring

G	I	 mm	H mm	L mm	Art.-No.	
<b>Pg 13</b>	G3/8"	24	3	7	<b>35133/8G</b>	50
<b>Pg 16</b>	G1/2"	24	14	10	<b>36161/2G.08</b>	50
<b>Pg 21</b>	G3/4"	32	14	12	<b>36213/4G.08</b>	25
<b>Pg 36</b>	G 2"	64	20	12	<b>3636.48.08</b>	10
<b>Pg 42</b>	G 2"	64	20	15	<b>3642.48.08</b>	10



Aussengewinde Gasrohr  
 Innengewinde Pg  
 Mit O-Ring

Outer thread gas-pipe  
 Inner thread Pg  
 with O-ring

G	I	 mm	H mm	L mm	Art.-No.	
<b>G3/8"</b>	Pg 7	20	3	10	<b>353/8G.07</b>	50
<b>G1/2"</b>	Pg 9	24	3	9.5	<b>351/2G.09</b>	50
<b>G3/4"</b>	Pg 9	30	3.5	11	<b>353/4G.09</b>	50
<b>G3/4"</b>	Pg 11	30	3.5	11	<b>353/4G.11</b>	50
<b>G3/4"</b>	Pg 16	32	3.5	11	<b>353/4G.16</b>	50
<b>G 1"</b>	Pg 21	38	3.5	11	<b>351G.21</b>	25
<b>G 1 1/4"</b>	Pg 29	50	5	11	<b>3511/4G.29</b>	25
<b>G 2"</b>	Pg 36	64	5	11	<b>352G.36</b>	10
<b>G 2"</b>	Pg 42	64	5	11	<b>352G.42</b>	10



Aussengewinde Gasrohr  
 Gewinde innen Pg  
 Mit O-Ring

Outer thread gas-pipe  
 Inner thread Pg  
 with O-ring

G	I	 mm	H mm	L mm	Art.-No.	
<b>G3/8"</b>	Pg 11	20	12	10	<b>363/8G.11.08</b>	50
<b>G1/2"</b>	Pg 11	24	12	10	<b>361/2G.11.08</b>	50
<b>G1/2"</b>	Pg 13	24	12	10	<b>361/2G.13.08</b>	50
<b>G1/2"</b>	Pg 16	24	12	10	<b>361/2G.16.08</b>	50
<b>G5/8"</b>	Pg 16	24	12	10	<b>365/8G.16.08</b>	50
<b>G3/4"</b>	Pg 21	32	15	12	<b>363/4G.21.08</b>	25
<b>G7/8"</b>	Pg 29	41	15	12	<b>367/8G.29.08</b>	25
<b>G 1"</b>	Pg 29	41	15	11	<b>361G.29.08</b>	25
<b>G 1 1/2"</b>	Pg 36	54	22	12	<b>3611/2G.36.08</b>	10

## mit 6-kant | hexagonal

Material: Messing vernickelt  
 Gewinde: IP 68, wenn Anschlussge-  
 winde abgedichtet  
 Einsatztemperatur: -40 °C / +100 °C

Material: Nickel-plated brass  
 Entry thread: IP 68, if the entry thread  
 is sealed  
 Operation temperature: -40 °C / +100 °C

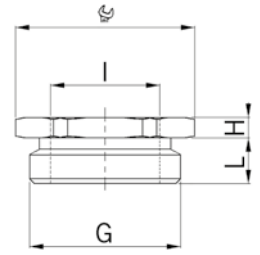

Aussengewinde NPT  
 Innengewinde Pg  
 Ohne O-Ring

Outer thread NPT  
 Inner thread Pg  
 without O-Ring

G	I	 mm	H mm	L mm	Art.-No.	
NPT1/2"	Pg 9	22	4.5	20	351/2NPT.09	50
NPT3/4"	Pg 11	30	4	20	353/4NPT.11	10
NPT3/4"	Pg 13	30	4	20	353/4NPT.13	10
NPT 1"	Pg 16	36	6	26	351NPT.16	10

## mit 6-kant | hexagonal

Material: Messing vernickelt  
 O-Ring: NBR  
 Gewinde: IP 68, wenn Anschlussge-  
 winde abgedichtet  
 Einsatztemperatur: -40 °C / +100 °C

Material: Nickel-plated brass  
 O-ring: NBR  
 Entry thread: IP 68, if the entry thread  
 is sealed  
 Operation temperature: -40 °C / +100 °C

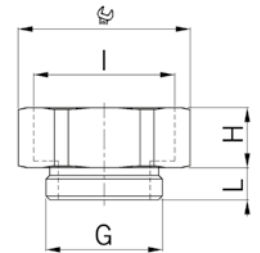

Aussengewinde NPT  
 Innengewinde Pg  
 Ohne O-Ring

Outer thread NPT  
 Inner thread Pg  
 without O-Ring

G	I	 mm	H mm	L mm	Art.-No.	
NPT1/2"	Pg 11	24	12	20	361/2NPT.11	50
NPT1/2"	Pg 13	24	14	20	361/2NPT.13	50
NPT1/2"	Pg 16	34	20	20	361/2NPT.16	50
NPT3/4"	Pg 21	32	14	20	363/4NPT.21	25

1  
2  
3  
4  
5  
6  
7  
8  
9  
10  
11  
12  
13  
14  
15

# Reduktionen Kunststoff

## Synthetic reduction fittings

### mit 6-kant | hexagonal

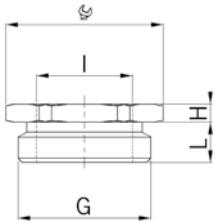



Material: Polyamid PA 6  
 Eigenschaften: halogenfrei  
 Schutzart: IP 54  
 Gewinde: IP 68, wenn Anschlussge-  
 winde abgedichtet  
 Einsatztemperatur: -30 °C / +100 °C

Material: Polyamide PA 6  
 Properties: halogen-free  
 Protection class: IP 54  
 Entry thread: IP 68, if the entry thread  
 is sealed  
 Operation temperature: -30 °C / +100 °C



Aussengewinde metrisch  
 Innengewinde metrisch  
 Hellgrau RAL 7035

Outer thread metric  
 Inner thread metric  
 Light grey RAL 7035

G	I	 mm	H mm	L mm	Art.-No.	
M16x1.5	M12x1.5	22	4	8	3455.17.12	100
M20x1.5	M12x1.5	24	4	8	3455.20.12	100
M20x1.5	M16x1.5	24	4	8	3455.20.17	100
M25x1.5	M12x1.5	29	6	8	3455.25.12	100
M25x1.5	M16x1.5	29	6	8	3455.25.17	100
M25x1.5	M20x1.5	29	6	8	3455.25.20	100
M32x1.5	M12x1.5	36	6	10	3455.32.12	50
M32x1.5	M16x1.5	36	6	10	3455.32.17	50
M32x1.5	M20x1.5	36	6	10	3455.32.20	50
M32x1.5	M25x1.5	36	6	10	3455.32.25	50
M40x1.5	M16x1.5	46	6	10	3455.40.17	50
M40x1.5	M20x1.5	46	6	10	3455.40.20	50
M40x1.5	M25x1.5	46	6	10	3455.40.25	25
M40x1.5	M32x1.5	46	6	10	3455.40.32	25
M50x1.5	M20x1.5	55	6	12	3455.50.20	5
M50x1.5	M25x1.5	55	6	12	3455.50.25	5
M50x1.5	M32x1.5	55	6	12	3455.50.32	5
M50x1.5	M40x1.5	55	6	12	3455.50.40	5
M63x1.5	M25x1.5	68	6	12	3455.63.25	5
M63x1.5	M32x1.5	68	6	12	3455.63.32	5
M63x1.5	M40x1.5	68	6	12	3455.63.40	5
M63x1.5	M50x1.5	68	6	12	3455.63.50	5

### mit 6-kant | hexagonal

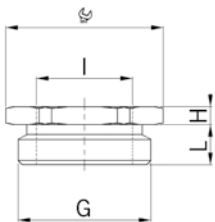

Material: Polyamid  
 glasfaserverstärkt  
 Schutzart: IP 54  
 Gewinde: IP 68, wenn Anschlussge-  
 winde abgedichtet  
 Einsatztemperatur: -20 °C / +100 °C

Material: Polyamide  
 glass fiber reinforced  
 Protection class: IP 54  
 Entry thread: IP 68, if the entry thread  
 is sealed  
 Operation temperature: -20 °C / +100 °C



Aussengewinde Pg  
 Innengewinde Pg  
 Hellgrau

Outer thread Pg  
 Inner thread Pg  
 Light grey

G	I	 mm	H mm	L mm	Art.-No.	
Pg 9	Pg 7	19	12	8	3409.07	50
Pg 11	Pg 7	22	3	8	3411.07	50
Pg 11	Pg 9	22	15	8	3411.09	50
Pg 13	Pg 9	24	3	9	3413.09	50
Pg 13	Pg 11	24	15	9	3413.11	50
Pg 16	Pg 9	27	5	9	3416.09	50
Pg 16	Pg 11	27	5	9	3416.11	50
Pg 16	Pg 13	27	17	10	3416.13	50
Pg 21	Pg 13	32	5	11	3421.13	25
Pg 21	Pg 16	32	5	11	3421.16	25
Pg 29	Pg 21	41	6	12	3429.21	10
Pg 36	Pg 29	50	6	14	3436.29	10

## rund mit 6-kant | round with hexagon

Material: Polyamid PA 6  
Eigenschaften: halogenfrei  
Schutzart: IP 54  
Gewinde: IP 68, wenn Anschlussge-  
winde abgedichtet  
Einsatztemperatur: -30 °C / +100 °C

Material: Polyamide PA 6  
Properties: halogen-free  
Protection class: IP 54  
Entry thread: IP 68, if the entry thread  
is sealed  
Operation temperature: -30 °C / +100 °C

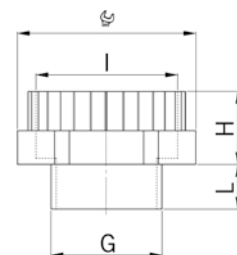

Aussengewinde metrisch  
Innengewinde metrisch  
Hellgrau RAL 7035

Outer thread metric  
Inner thread metric  
Light grey RAL 7035

G	I	 mm	H mm	L mm	Art.-No.	
M12x1.5	M16x1.5	20	13	8	3755.12.17	100
M16x1.5	M20x1.5	24	13	8	3755.17.20	100
M20x1.5	M25x1.5	29	13	8	3755.20.25	100
M25x1.5	M32x1.5	36	15	8	3755.25.32	50
M32x1.5	M40x1.5	46	15	10	3755.32.40	25
M40x1.5	M50x1.5	55	15	10	3755.40.50	10
M50x1.5	M63x1.5	68	15	10	3755.50.63	10



## rund mit 6-kant | round with hexagon

Material: Polyamid  
glasfaserverstärkt  
Schutzart: IP 54  
Gewinde: IP 68, wenn Anschlussge-  
winde abgedichtet  
Einsatztemperatur: -20 °C / +100 °C

Material: Polyamide  
glass fiber reinforced  
Protection class: IP 54  
Entry thread: IP 68, if the entry thread  
is sealed  
Operation temperature: -20 °C / +100 °C

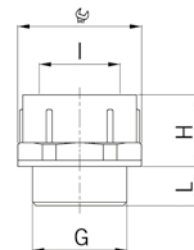

Aussengewinde Pg  
Innengewinde Pg  
Hellgrau

Outer thread Pg  
Inner thread Pg  
Light grey

G	I	 mm	H mm	L mm	Art.-No.	
Pg 7	Pg 9	19	18	7	3707.09	50
Pg 9	Pg 11	22	19	7	3709.11	50
Pg 11	Pg 13	24	21	8	3711.13	50
Pg 13	Pg 16	27	23	9	3713.16	50
Pg 16	Pg 21	32	26	9	3716.21	25
Pg 21	Pg 29	41	33	10	3721.29	25
Pg 29	Pg 36	55	39	12	3729.36	10
Pg 36	Pg 42	60	46	14	3736.42	10
Pg 42	Pg 48	65	39	16	3742.48	10



# Adapter Kunststoff

## Synthetic adapter

rund mit 6-kant | round with hexagon

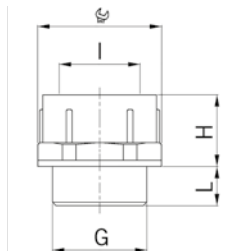

Material: Polyamid  
glasfaserverstärkt  
Schutzart: IP 54  
Gewinde: IP 68, wenn Anschlussge-  
winde abgedichtet  
Einsatztemperatur: -20 °C / +100 °C

Material: Polyamide  
glass fiber reinforced  
Protection class: IP 54  
Entry thread: IP 68, if the entry thread  
is sealed  
Operation temperature: -20 °C / +100 °C



Aussengewinde metrisch  
Innengewinde Pg  
Hellgrau

Outer thread metric  
Inner thread Pg  
Light grey

G	I	 mm	H mm	L mm	Art.-No.	
M12x1.5	Pg 9	19	13	11	3712.09	50
M20x1.5	Pg 13	24	15	11	3720.13	50
M20x1.5	Pg 16	27	17	11	3720.16	50
M25x1.5	Pg 21	33	20	11	3725.21	25
M32x1.5	Pg 29	42	22	11	3732.29	25
M50x1.5	Pg 42	60	28	11	3750.42	10

Aussengewinde metrisch  
Innengewinde Pg  
Hellgrau

Outer thread metric  
Inner thread Pg  
Light grey

G	I	 mm	H mm	L mm	Art.-No.	
M16x1.5	Pg 9	19	14	11	3417.09	50
M20x1.5	Pg 11	22	16	11	3420.11	50
M25x1.5	Pg 16	27	18	11	3425.16	50
M40x1.5	Pg 29	42	23	11	3440.29	25
M50x1.5	Pg 36	53	26	11	3450.36	10
M63x1.5	Pg 48	65	29	11	3463.48	5

## rund mit 6-kant | round with hexagon

Material: Polyamid PA 6  
Eigenschaften: halogenfrei  
Schutzart: IP 54  
Gewinde: IP 68, wenn Anschlussge-  
winde abgedichtet  
Einsatztemperatur: -30 °C / +100 °C

Material: Polyamide PA 6  
Properties: halogen-free  
Protection class: IP 54  
Entry thread: IP 68, if the entry thread  
is sealed  
Operation temperature: -30 °C / +100 °C

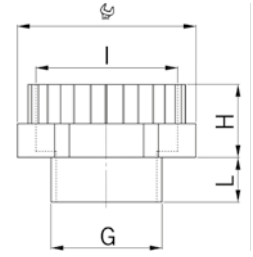

Aussengewinde Pg  
Innengewinde metrisch  
Hellgrau RAL 7035

Outer thread Pg  
Inner thread metric  
Light grey RAL 7035

G	I	 mm	H mm	L mm	Art.-No.	
Pg 7	M12x1.5	15	12	8	3755.07.12	100
Pg 7	M16x1.5	20	12	8	3755.07.17	100
Pg 9	M16x1.5	20	12	8	3755.09.17	100
Pg 9	M20x1.5	24	12	8	3755.09.20	100
Pg 11	M20x1.5	24	12	8	3755.11.20	100
Pg 13	M25x1.5	30	13	9	3755.13.25	100
Pg 16	M25x1.5	30	13	10	3755.16.25	50
Pg 21	M32x1.5	37	14	11	3755.21.32	50
Pg 29	M40x1.5	45	14	11	3755.29.40	50
Pg 42	M50x1.5	55	17	11	3755.42.50	10
Pg 48	M63x1.5	68	17	11	3755.48.63	5

Aussengewinde Pg  
Innengewinde metrisch  
Hellgrau RAL 7035

Outer thread Pg  
Inner thread metric  
Light grey RAL 7035

G	I	 mm	H mm	L mm	Art.-No.	
Pg 9	M12x1.5	19	12	8	3455.09.12	100
Pg 11	M16x1.5	22	12	8	3455.11.17	100
Pg 13	M16x1.5	24	13	9	3455.13.17	100
Pg 13	M20x1.5	24	13	9	3455.13.20	100
Pg 16	M20x1.5	27	13	10	3455.16.20	50
Pg 21	M25x1.5	33	14	11	3455.21.25	50
Pg 29	M32x1.5	42	14	11	3455.29.32	50
Pg 36	M40x1.5	55	14	11	3455.36.40	25

# Verschlusschraube Messing

## Locking plug nickel-plated brass

### Kurzes Anschlussgewinde metrisch | Short entry thread metric

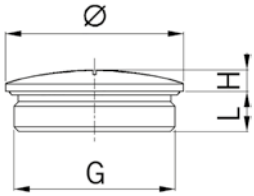

Material: Messing vernickelt  
 O-Ring: NBR  
 Schutzart: IP 68  
 Einsatztemperatur: -40 °C / +100 °C

Material: Nickel-plated brass  
 O-ring: NBR  
 Protection class: IP 68  
 Operation temperature: -40 °C / +100 °C



Runde Bauform  
 Mit O-Ring

Round execution  
 with O-ring

G	Ø mm	H mm	L mm	i info	Art.-No.	
M6x1.0	9	3	5	1	8706.08	50
M8x1.25	10	3	5	1	8708.08	50
M10x1.5	12	3	5	1	8710.08	50
M12x1.5	14	3	5	-	8712.08	50
M16x1.5	19	3	5	-	8717.08	50
M20x1.5	24	3	6	-	8720.08	25
M25x1.5	28	4	7	-	8725.08	25
M32x1.5	35	4	8	-	8732.08	10
M40x1.5	45	6	8	-	8740.08	10
M50x1.5	55	6	9	-	8750.08	10
M63x1.5	70	6	10	-	8763.08	10
M75x1.5	80	6	11	-	8775.08	5

1 = Metrisches Regelgewinde

1 = Metric coarse-pitch thread

### Langes Anschlussgewinde metrisch | Long entry thread metric



Runde Bauform  
 Mit O-Ring

Round execution  
 with O-ring

G	Ø mm	H mm	L mm	i info	Art.-No.	
M6x1.0	9	3	8	1	8706.11.08	50
M8x1.25	10	3	10	1	8708.11.08	50
M10x1.5	12	3	10	1	8710.11.08	50
M12x1.5	14	3	10	-	8712.11.08	50
M16x1.5	19	3	10	-	8717.11.08	50
M20x1.5	24	3	10	-	8720.11.08	25
M25x1.5	28	4	11	-	8725.11.08	25
M32x1.5	35	4	13	-	8732.11.08	10
M40x1.5	45	6	13	-	8740.11.08	10
M50x1.5	55	6	14	-	8750.11.08	10
M63x1.5	70	6	15	-	8763.11.08	10
M75x1.5	80	6	15	-	8775.11.08	5

1 = Metrisches Regelgewinde

1 = Metric coarse-pitch thread

# Verschlusschraube Messing Locking plug nickel-plated brass

## Kurzes Anschlussgewinde metrisch | Short entry thread metric

Material: Messing vernickelt  
Schutzart: IP 54  
Gewinde: IP 68, wenn Anschlussgewinde abgedichtet  
Einsatztemperatur: -40 °C / +200 °C

Material: Nickel-plated brass  
Protection class: IP 54  
Entry thread: IP 68, if the entry thread is sealed  
Operation temperature: -40 °C / +200 °C

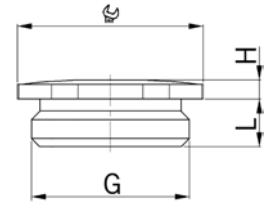

Mit 6-kant  
Ohne O-Ring

with hexagon  
without O-Ring

G	 mm	H mm	L mm	Art.-No.	
M12x1.5	14	2.5	5	8745.12	100
M16x1.5	18	2.5	5	8745.17	100
M20x1.5	22	2.5	6	8745.20	100
M25x1.5	27	3.0	7	8745.25	50
M32x1.5	34	3.5	8	8745.32	25
M40x1.5	42	4.0	8	8745.40	25
M50x1.5	52	4.0	9	8745.50	10
M63x1.5	65	4.0	10	8745.63	10



## Kurzes Anschlussgewinde metrisch | Short entry thread metric

Material: Messing vernickelt  
O-Ring: NBR  
Schutzart: IP 68  
Einsatztemperatur: -40 °C / +100 °C

Material: Nickel-plated brass  
O-ring: NBR  
Protection class: IP 68  
Operation temperature: -40 °C / +100 °C

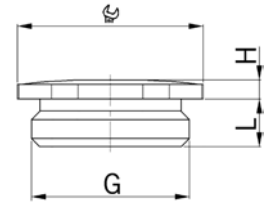

Mit 6-kant  
Mit O-Ring

with hexagon  
with O-ring

G	 mm	H mm	L mm	Art.-No.	
M12x1.5	15	2.8	5	8745.12.08	50
M16x1.5	18	3.2	5	8745.17.08	100
M20x1.5	24	3.6	6	8745.20.08	100
M25x1.5	30	4.5	7	8745.25.08	10
M32x1.5	36	4.8	8	8745.32.08	10
M40x1.5	46	6.0	8	8745.40.08	25
M50x1.5	55	7.0	9	8745.50.08	10
M63x1.5	70	8.0	10	8745.63.08	10



Auf Anfrage lieferbar:

Available on request:

Langes Anschlussgewinde metrisch

Long entry thread metric

# Verschlusschraube Messing

## Locking plug nickel-plated brass

### Kurzes Anschlussgewinde Pg | Short entry thread Pg

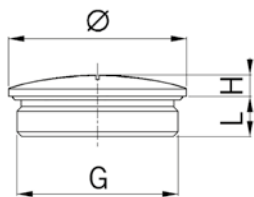

Material: Messing vernickelt  
 O-Ring: NBR  
 Schutzart: IP 68  
 Einsatztemperatur: -40 °C / +100 °C

Material: Nickel-plated brass  
 O-ring: NBR  
 Protection class: IP 68  
 Operation temperature: -40 °C / +100 °C



Runde Bauform  
 Mit O-Ring

Round execution  
 with O-ring

G	Ø mm	H mm	L mm	Art.-No.	
<b>Pg 7</b>	14	3	5	<b>8707.08</b>	100
<b>Pg 9</b>	17	3	6	<b>8709.08</b>	100
<b>Pg 11</b>	20	3	6	<b>8711.08</b>	100
<b>Pg 13</b>	22	3	6.5	<b>8713.08</b>	50
<b>Pg 16</b>	24	3	6.5	<b>8716.08</b>	50
<b>Pg 21</b>	30	4	7	<b>8721.08</b>	10
<b>Pg 29</b>	39	4	8	<b>8729.08</b>	10
<b>Pg 36</b>	50	6	9	<b>8736.08</b>	10
<b>Pg 42</b>	60	6	10	<b>8742.08</b>	10
<b>Pg 48</b>	65	6	10	<b>8748.48.08</b>	10
<b>G 2"</b>	65	6	10	<b>8748.08</b>	10

### Langes Anschlussgewinde Pg | Long entry thread Pg



Runde Bauform  
 Mit O-Ring

Round execution  
 with O-ring

G	Ø mm	H mm	L mm	Art.-No.	
<b>Pg 7</b>	14	3	10	<b>8707.11.08</b>	100
<b>Pg 9</b>	17	3	10	<b>8709.11.08</b>	100
<b>Pg 11</b>	20	3	10	<b>8711.11.08</b>	100
<b>Pg 13</b>	22	3	10	<b>8713.11.08</b>	50
<b>Pg 16</b>	24	3	10	<b>8716.11.08</b>	50
<b>Pg 21</b>	30	4	12	<b>8721.11.08</b>	10
<b>Pg 29</b>	39	4	12	<b>8729.11.08</b>	10
<b>Pg 36</b>	50	6	15	<b>8736.11.08</b>	10

### Kurzes Anschlussgewinde metrisch | Short entry thread metric

Material: Rostfreier CrNi-Stahl A2  
(DIN EN 1.4305 / AISI 303)  
O-Ring: NBR  
Schutzart: IP 68  
Einsatztemperatur: -40 °C / +100 °C

Material: CrNi stainless steel A2  
(DIN EN 1.4305 / AISI 303)  
O-ring: NBR  
Protection class: IP 68  
Operation temperature: -40 °C / +100 °C

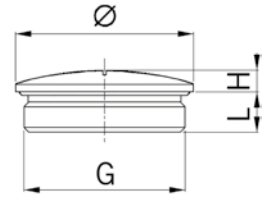

Runde Bauform  
Mit O-Ring

Round execution  
with O-ring

G	Ø mm	H mm	L mm	i info	Art.-No.	
M10x1.5	12	3	5	1	8710.96.08.70	50
M12x1.5	14	3	5	-	8712.96.08.70	50
M16x1.5	19	3	5	-	8717.96.08.70	50
M20x1.5	24	3	6	-	8720.96.08.70	25
M25x1.5	28	4	7	-	8725.96.08.70	25
M32x1.5	35	4	8	-	8732.96.08.70	10
M40x1.5	45	6	8	-	8740.96.08.70	10
M50x1.5	55	6	9	-	8750.96.08.70	10
M63x1.5	70	6	10	-	8763.96.08.70	10
M75x1.5	80	6	11	-	8775.96.08.70	5

1 = Metrisches Regelgewinde

1 = Metric coarse-pitch thread

Auf Anfrage lieferbar:

Available on request:

Anschlussgewinde Pg

Entry thread Pg



### Langes Anschlussgewinde metrisch | Long entry thread metric

Runde Bauform  
Mit O-Ring

Round execution  
with O-ring

G	Ø mm	H mm	L mm	i info	Art.-No.	
M10x1.5	12	3	10	1	8710.96.11.08.70	50
M12x1.5	14	3	10	-	8712.96.11.08.70	50
M16x1.5	19	3	10	-	8717.96.11.08.70	50
M20x1.5	24	3	10	-	8720.96.11.08.70	25
M25x1.5	28	4	11	-	8725.96.11.08.70	25
M32x1.5	35	4	13	-	8732.96.11.08.70	10
M40x1.5	45	6	13	-	8740.96.11.08.70	10
M50x1.5	55	6	14	-	8750.96.11.08.70	10
M63x1.5	70	6	15	-	8763.96.11.08.70	10
M75x1.5	80	6	15	-	8775.96.11.08.70	5

1 = Metrisches Regelgewinde

1 = Metric coarse-pitch thread

Auf Anfrage lieferbar:

Available on request:

Anschlussgewinde Pg

Entry thread Pg



# Verschlusschrauben rostfreier Stahl A2 für hohe Temperaturen

## Locking plugs stainless steel A2 for high temperature applications

### Kurzes Anschlussgewinde metrisch | Short entry thread metric

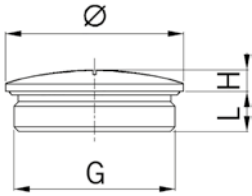

Material: Rostfreier CrNi-Stahl A2 (DIN EN 1.4305 / AISI 303)  
 O-Ring: FPM  
 Schutzart: IP 68  
 Einsatztemperatur: -40 °C / +200 °C

Material: CrNi stainless steel A2 (DIN EN 1.4305 / AISI 303)  
 O-ring: FPM  
 Protection class: IP 68  
 Operation temperature: -40 °C / +200 °C



Runde Bauform  
Mit O-Ring

Round execution  
with O-ring

G	Ø mm	H mm	L mm	i info	Art.-No.	
M10x1.5	12	3	5	1	8710.96.08	50
M12x1.5	14	3	5	-	8712.96.08	50
M16x1.5	19	3	5	-	8717.96.08	50
M20x1.5	24	3	6	-	8720.96.08	25
M25x1.5	28	4	7	-	8725.96.08	25
M32x1.5	35	4	8	-	8732.96.08	10
M40x1.5	45	6	8	-	8740.96.08	10
M50x1.5	55	6	9	-	8750.96.08	10
M63x1.5	70	6	10	-	8763.96.08	10
M75x1.5	80	6	11	-	8775.96.08	5

1 = Metrisches Regelgewinde

1 = Metric coarse-pitch thread

Auf Anfrage lieferbar:

Available on request:

Anschlussgewinde Pg

Entry thread Pg

### Langes Anschlussgewinde metrisch | Long entry thread metric



Runde Bauform  
Mit O-Ring

Round execution  
with O-ring

G	Ø mm	H mm	L mm	i info	Art.-No.	
M10x1.5	12	3	10	1	8710.96.11.08	50
M12x1.5	14	3	10	-	8712.96.11.08	50
M16x1.5	19	3	10	-	8717.96.11.08	50
M20x1.5	24	3	10	-	8720.96.11.08	25
M25x1.5	28	4	11	-	8725.96.11.08	25
M32x1.5	35	4	13	-	8732.96.11.08	10
M40x1.5	45	6	13	-	8740.96.11.08	10
M50x1.5	55	6	14	-	8750.96.11.08	10
M63x1.5	70	6	15	-	8763.96.11.08	10
M75x1.5	80	6	15	-	8775.96.11.08	5

1 = Metrisches Regelgewinde

1 = Metric coarse-pitch thread

Auf Anfrage lieferbar:

Available on request:

Anschlussgewinde Pg

Entry thread Pg

### Anschlussgewinde metrisch | Entry thread metric

Material: Polyamid PA 6  
 Schutzart: IP 54  
 Gewinde: IP 68, wenn Anschlussgewinde abgedichtet  
 Einsatztemperatur: -30 °C / +100 °C

Material: Polyamide PA 6  
 Protection class: IP 54  
 Entry thread: IP 68, if the entry thread is sealed  
 Operation temperature: -30 °C / +100 °C

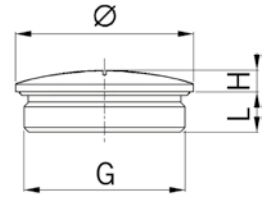

Hellgrau RAL 7035 Ohne O-Ring				Light grey RAL 7035 without O-Ring	
G	Ø mm	H mm	L mm	Art.-No.	
M12x1.5	15	4.5	6	8855.12	100
M16x1.5	20	4.5	6	8855.17	100
M20x1.5	24	4.5	6	8855.20	100
M25x1.5	30	5.0	8	8855.25	100
M32x1.5	37	5.5	8	8855.32	50
M40x1.5	46	6.0	8	8855.40	50
M50x1.5	56	6.0	10	8855.50	10
M63x1.5	70	6.0	12	8855.63	10



Schwarz RAL 9005 Ohne O-Ring				Black RAL 9005 without O-Ring	
G	Ø mm	H mm	L mm	Art.-No.	
M12x1.5	15	4.5	6	8845.12	100
M16x1.5	20	4.5	6	8845.17	100
M20x1.5	24	4.5	6	8845.20	100
M25x1.5	30	5.0	8	8845.25	100
M32x1.5	37	5.5	8	8845.32	50
M40x1.5	46	6.0	8	8845.40	50
M50x1.5	56	6.0	10	8845.50	10
M63x1.5	70	6.0	12	8845.63	10



### Anschlussgewinde Pg | Entry thread Pg

Material: Polystyrol schlagfest  
 Schutzart: IP 54  
 Gewinde: IP 68, wenn Anschlussgewinde abgedichtet  
 Einsatztemperatur: -20 °C / +80 °C

Material: Shock-resistant polystyrene  
 Protection class: IP 54  
 Entry thread: IP 68, if the entry thread is sealed  
 Operation temperature: -20 °C / +80 °C

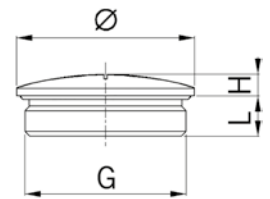

Hellgrau RAL 7035 Ohne O-Ring				Light grey RAL 7035 without O-Ring	
G	Ø mm	H mm	L mm	Art.-No.	
Pg 7	15	2.0	6.0	8807	100
Pg 9	19	3.0	6.5	8809	100
Pg 11	22	3.5	6.5	8811	100
Pg 13	25	3.5	6.5	8813	100
Pg 16	27	3.5	6.5	8816	100
Pg 21	33	4.0	8.0	8821	100
Pg 29	44	4.0	8.0	8829	50
Pg 36	55	4.0	10.0	8836	25
Pg 42	62	6.0	10.0	8842	10



1  
2  
3  
4  
5  
6  
7  
8  
9  
10  
11  
12  
13  
14  
15

# Dichteinsätze Vollgummi

## Solid rubber sealing inserts

passend zu Kabelverschraubungen Progress® | suitable for cable glands Progress®

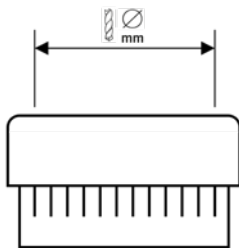

Material: NBR  
Einsatztemperatur: -40 °C / +100 °C

Material: NBR  
Operation temperature: -40 °C / +100 °C



Kurzer Dichteinsatz ohne Bohrung

Short sealing insert without drilled hole

G	 mm	Art.-No.	
M6	3.5	1000.06.30.03	1
M8	5.0	1000.08.30.03	1
M10	6.0	1000.10.30.03	1
Pg 11	12.0	1000.11.30.03	1
M12 / Pg 7	8.0	1000.12.30.03	1
M16 / Pg 9	10.5	1000.17.30.03	1
M20 / Pg 13 / Pg 16	15.0	1000.20.30.03	1
M25 / Pg 21	20.5	1000.25.30.03	1
Pg 29	27.5	1000.29.30.03	1
M32	25.5	1000.32.30.03	1
Pg 36	35.0	1000.36.30.03	1
M40	33.0	1000.40.30.03	1
Pg 48	49.0	1000.48.30.03	1
M50 / Pg 42	42.0	1000.50.30.03	1
M63	52.0	1000.63.30.03	1
M75	63.0	1000.75.30.03	1
M85	70.0	1000.085.30.03	1
M95	80.0	1000.095.30.03	1
M100	85.0	1000.100.30.03	1
M105	90.0	1000.105.30.03	1
M115	95.0	1000.115.30.03	1

Dichteinsätze ohne Bohrung lassen sich gut bearbeiten, wenn sie vorher auf mindestens -25°C gefroren wurden.

When frozen to at least -25°C, the solid sealing inserts are easy to drill.

# Dichteinsätze Vollgummi für hohe Temperaturen Solid rubber sealing inserts for high temperatures applications

passend zu Kabelverschraubungen Progress® | suitable for cable glands Progress®

Material: FPM  
Einsatztemperatur: -40 °C / +200 °C

Material: FPM  
Operation temperature: -40 °C / +200 °C

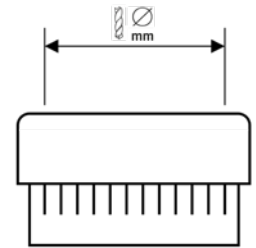

Kurzer Dichteinsatz ohne Bohrung

Short sealing insert without drilled hole

<b>G</b>	 mm	<b>Art.-No.</b>	
M6	3.5	1000.06.98.30.03	1
M8	5.0	1000.08.98.30.03	1
M10	6.0	1000.10.98.30.03	1
Pg 11	12.0	1000.11.98.30.03	1
M12 / Pg 7	8.0	1000.12.98.30.03	1
M16 / Pg 9	10.5	1000.17.98.30.03	1
M20 / Pg 16	15.0	1000.20.98.30.03	1
M25 / Pg 21	20.5	1000.25.98.30.03	1
Pg 29	27.5	1000.29.98.30.03	1
M32	25.5	1000.32.98.30.03	1
Pg 36	35.0	1000.36.98.30.03	1
M40 / Pg 29	33.0	1000.40.98.30.03	1
Pg 48	49.0	1000.48.98.30.03	1
M50 / Pg 42	42.0	1000.50.98.30.03	1
M63	52.0	1000.63.98.30.03	1

Dichteinsätze ohne Bohrung lassen sich gut bearbeiten, wenn sie vorher auf mindestens -25°C gefroren wurden.

When frozen to at least -25°C, the solid sealing inserts are easy to drill.

1  
2  
3  
4  
5  
6  
7  
8  
9  
10  
11  
12  
13  
14  
15

passend zu Kabelverschraubungen Progress® | suitable for cable glands Progress®

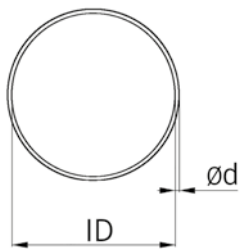

Material: NBR  
Einsatztemperatur: -40 °C / +100 °C

Material: NBR  
Operation temperature: -40 °C / +100 °C



Zu Anschlussgewinde metrisch oder Pg

suitable for entry thread metric or Pg

G	øl mm	ød mm	Art.-No.	
M 6	5.0	1.0	1005.00.08	1
M 8	6.0	1.5	1006.00.08	1
M10	8.1	1.6	1006.06.08	1
M12 / Pg 7	10.0	1.5	1007.00.08	1
M16 / Pg 9	13.1	1.6	1000.09.00.08	1
M20	17.0	2.0	2111.00.08	1
M25	22.0	2.0	1013.00.22.08	1
M32	30.0	2.0	1021.00.30.08	1
M40	36.0	2.0	1000.40.00.08	1
M50	46.0	2.0	1000.50.00.08	1
M63	60.0	2.0	1000.63.00.08	1
M75	72.0	2.0	1000.75.00.08	1
Pg 11	15.0	2.0	1011.00.08	1
Pg 13 / Pg 16	19.0	2.0	1016.00.08	1
Pg 21	25.0	2.0	1016.00.25.08	1
Pg 29	33.3	2.4	1029.00.08	1
Pg 36	42.5	2.6	1036.00.08	1
Pg 42	48.0	3.0	1000.42.00.08	1
Pg 48	55.0	2.0	1000.48.00.08	1

passend zu Kabelverschraubungen Progress® | suitable for cable glands Progress®

Material: FPM  
Einsatztemperatur: -40 °C / +200 °C

Material: FPM  
Operation temperature: -40 °C / +200 °C

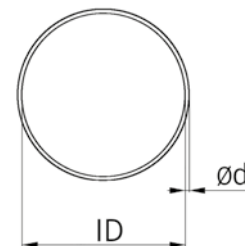

Zu Anschlussgewinde metrisch oder Pg

suitable for entry thread metric or Pg

G	Øl mm	Ød mm	Art.-No.	
M 6	5.0	1.0	1105.98.08	1
M 8	6.0	1.8	1106.98.08	1
M10	8.1	1.6	1106.06.98.08	1
M12 / Pg 7	10.0	1.5	1107.98.08	1
M16 / Pg 9	13.1	1.6	1100.09.98.08	1
M20	17.0	2.0	2111.98.08	1
M25	22.0	2.0	1113.98.22.08	1
M32	30.0	2.0	1121.98.30.08	1
M40	36.0	2.0	1100.40.98.08	1
M50	46.0	2.0	1100.50.98.08	1
M63	60.0	2.0	1100.63.98.08	1
M75	72.0	2.0	1100.75.98.08	1
Pg 11	15.0	2.0	1111.98.08	1
Pg 13 / Pg 16	18.0	2.0	1116.98.08	1
Pg 21	25.0	2.0	1116.98.25.08	1
Pg 29	31.4	2.2	1129.98.08	1
Pg 36	42.5	2.6	1136.98.08	1

# Dichtungsscheiben

## Sealing washers

passend zu Kabelverschraubungen Progress® | suitable for cable glands Progress®

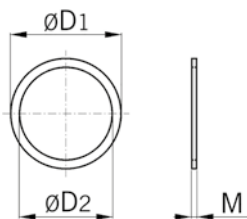

Material: KlingerSIL C-4300  
 Farbe: grün  
 Einsatztemperatur: -60 °C / +300 °C

Material: KlingerSIL C-4300  
 Colour: green  
 Operation temperature: -60 °C / +300 °C



zu Anschlussgewinde metrisch

suitable for metric entry thread

G	ØD1 mm	ØD2 mm	M mm	Art.-No.	
M6	10.0	6.0	1.5	1006.00.16	50
M8	12.0	8.0	1.5	1008.00.16	50
M10	14.0	10.0	1.5	1010.00.16	50
M12	16.0	12.0	1.5	1012.00.16	50
M16	21.0	16.0	1.5	1017.00.16	50
M20 / Pg 13	25.0	20.5	1.5	1013.00.16	50
M25	31.0	25.0	2.0	1025.00.16	50
M32	39.0	32.0	2.0	1032.00.16	50
M40	48.0	40.0	2.0	1040.00.16	50
M50	59.0	50.0	2.0	1050.00.16	50
M63	73.0	63.0	2.0	1063.00.16	50

zu Anschlussgewinde Pg

suitable for entry thread Pg

G	ØD1 mm	ØD2 mm	M mm	Art.-No.	
Pg 7	16.5	12.5	1.5	1007.00.16	50
Pg 9	19.0	15.2	1.5	1009.00.16	50
Pg 11	22.5	18.5	1.5	1011.00.16	50
M20 / Pg 13	25.0	20.5	1.5	1013.00.16	50
Pg 16	27.0	22.5	1.5	1016.00.16	50
Pg 21	33.5	28.5	2.0	1021.00.16	50
Pg 29	43.5	37.0	2.0	1029.00.16	50
Pg 36	55.0	47.0	2.0	1036.00.16	50
Pg 42	63.0	54.0	2.0	1042.00.16	50
Pg 48	69.0	59.3	2.0	1048.00.16	50

passend zu Kabelverschraubungen Syntec® | suitable for cable glands Syntec®

Material: Perbunan  
Einsatztemperatur: -20 °C / +120 °C

Material: Perbunan  
Operation temperature: -20 °C / +120 °C

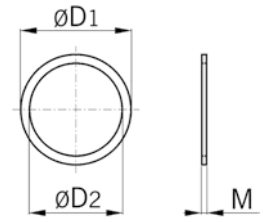

zu Anschlussgewinde metrisch

suitable for metric entry thread

G	ØD1 mm	ØD2 mm	M mm	Art.-No.	
<b>M12</b>	20	12	1.5	<b>1012.45.16</b>	50
<b>M16</b>	23	16	2.0	<b>1017.45.16</b>	50
<b>M20</b>	29	20	2.0	<b>1020.45.16</b>	50
<b>M25</b>	37	25	2.0	<b>1025.45.16</b>	50
<b>M32</b>	44	32	2.0	<b>1032.45.16</b>	25
<b>M40</b>	52	40	2.0	<b>1040.45.16</b>	25
<b>M50</b>	64	50	2.5	<b>1050.45.16</b>	25
<b>M63</b>	66	60.5	3.0	<b>1063.45.16</b>	10



zu Anschlussgewinde Pg

suitable for entry thread Pg

G	ØD1 mm	ØD2 mm	M mm	Art.-No.	
<b>Pg 7</b>	16.0	11.5	2.0	<b>1007.45.16</b>	50
<b>Pg 9</b>	19.0	14.0	2.0	<b>1009.45.16</b>	50
<b>Pg 11</b>	22.5	18.5	2.0	<b>1011.45.16</b>	50
<b>Pg 13</b>	25.0	19.0	2.0	<b>1013.45.16</b>	50
<b>Pg 16</b>	27.0	21.0	2.0	<b>1016.45.16</b>	50
<b>Pg 21</b>	34.0	27.0	2.5	<b>1021.45.16</b>	25
<b>Pg 29</b>	43.0	35.0	2.5	<b>1029.45.16</b>	25
<b>Pg 36</b>	54.0	45.0	2.5	<b>1036.45.16</b>	25

1  
2  
3  
4  
5  
6  
7  
8  
9  
10  
11  
12  
13  
14  
15

# Blindscheiben

## Blind discs

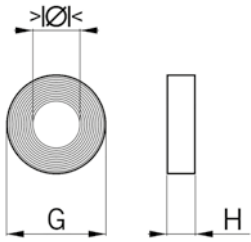

Material: NBR  
 Einsatzbereich: Passend zu Stopfbuchsen B107 - B263  
 Einsatztemperatur: -20 °C / +100 °C

Material: NBR  
 Application: Suitable for cable glands series B107 - B263  
 Operation temperature: -20 °C / +100 °C



G	>Ø< min mm	>Ø< max mm	H mm	Art.-No.	
M12 / Pg 7	6.0	8.0	5.0	B 107.00.03	50
M16 / Pg 9	4.0	11.0	5.5	B 109.00.03	50
Pg 11	6.5	12.0	6.0	B 111.00.03	50
Pg 13	6.5	13.5	6.0	B 113.00.03	50
M20 / Pg 16	6.5	16.0	7.0	B 116.00.03	50
M25 / Pg 21	9.0	20.0	8.0	B 121.00.03	50
M32 / Pg 29	17.0	28.0	9.5	B 129.00.03	50
M40 / Pg 36	23.0	34.0	12.0	B 136.00.03	50
M50 / Pg 42	29.0	40.0	14.0	B 142.00.03	10
M63 / Pg 48	35.0	46.0	14.0	B 148.00.03	10

### Blindscheiben passend zu Kabelverschraubungen | Blind discs suitable for cable glands

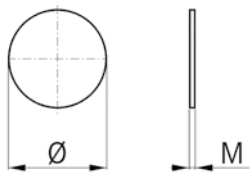

Material: Polyamid  
 Einsatzbereich: Staubverschluss zu Kabelverschraubungen  
 Einsatztemperatur: -20 °C / +100 °C

Material: Polyamide  
 Application: Dust stopper for cable glands  
 Operation temperature: -20 °C / +100 °C



G	Ø mm	M mm	Art.-No.	
M10 / M12 / Pg 7	10.5	0.3	1012.00.19	50
M16 / Pg 9	13.5	0.3	1017.00.19	50
M20 / Pg 11	16.5	0.3	1011.00.19	50
Pg 13 / Pg 16	20.5	0.3	1020.00.19	50
M25 / Pg 21	26.5	0.3	1025.00.19	50
Pg 29	35.0	0.3	1029.00.19	50
M32	30.0	0.3	1032.00.19	50
Pg 36	45.0	0.3	1036.00.19	50
M40	38.0	0.3	1040.00.19	50
M50 / Pg 42	52.0	0.3	1050.00.19	50
M63 / Pg 48	57.0	0.3	1063.00.19	50

Blindscheibe als Staubschutz

Blind disc for dust protection

für Syntec M25 / for Syntec M25

für Syntec M50 / for Syntec M50

# Verschlussbolzen Messing vernickelt

## Locking pins nickel-plated brass

### aus Kunststoff zu Mehrfach-Kabelverschraubungen | syntetic, for multi-duct cable glands

Material: Polyamid PA 6  
 Einsatzbereich: Zum Verschliessen nicht belegter Bohrungen in Mehrfach-Kabelverschraubungen  
 Einsatztemperatur: -30 °C / +100 °C

Material: Polyamide PA 6  
 Application: Usable as inserts to close unused holes in sealings of multi-duct cable glands  
 Operation temperature: -30 °C / +100 °C

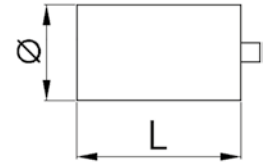

Verschlussbolzen zu Kabelverschraubungen		Locking pins for cable glands	
$\frac{>\text{Ø}<}{\text{mm}}$	L	Art.-No.	
2	12	1310.020.07	50
3	14	1310.030.07	50
4	14	1310.040.07	50
5	14	1310.050.07	50
6	14	1310.060.07	50
7	14	1310.070.07	50
8	14	1310.080.07	50
9	14	1310.090.07	50
10	14	1310.100.07	50
11	14	1310.110.07	50
12	14	1310.120.07	50



### für Multi-Kabelverschraubungen | for multi cable glands

Material: Messing vernickelt  
 Einsatzbereich: Zum Verschliessen nicht belegter Bohrungen in Mehrfach-Kabelverschraubungen  
 Einsatztemperatur: -60 °C / +100 °C

Material: Nickel-plated brass  
 Application: Usable as inserts to close unused holes in sealings of multi-duct cable glands  
 Operation temperature: -60 °C / +100 °C

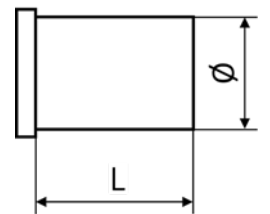

Verschlussbolzen zu Kabelverschraubungen		Locking pins for cable glands	
$\frac{>\text{Ø}<}{\text{mm}}$	L	Art.-No.	
1.5	6	EX1310.015.07	25
3	7	EX1310.030.07	25
4	7	EX1310.040.07	25
5	7	EX1310.050.07	25
6	7	EX1310.060.07	25
7	7	EX1310.070.07	25
9	9	EX1310.090.07	25
10	9	EX1310.100.07	25
12	11	EX1310.120.07	25
15	11	EX1310.150.07	25
18	12	EX1310.180.07	25

Einsetzbar auch für Ex Multi-Kabelverschraubungen    Can also be used for Ex multi cable glands



1  
2  
3  
4  
5  
6  
7  
8  
9  
10  
11  
12  
13  
14  
15

# Spezialwerkzeug für Kabelverschraubungen

## Special tool for cable glands

### Für Kabelverschraubungen | For cable glands

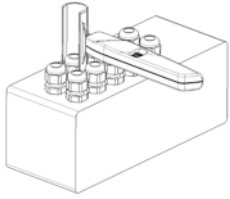

**Einsatzbereich:** Montagewerkzeug für Kabelverschraubungen bei engsten Platzverhältnissen

**Eigenschaften:** Nur 2 Werkzeuge für Schlüsselweiten von 11 bis 36 mm notwendig, Zeitersparnis durch Ratschenfunktion



**Application:** Assembly tool for cable glands in restricted spaces

**Properties:** Only 2 tools necessary for wrench sizes from 11 to 36 mm, time-saving due to the ratchet function



verstellbare Schlüsselweiten  
bei geringem Platzbedarf

adjustable wrench sizes  
for restricted spaces

 1 mm	 2 mm	<b>L</b> mm	<b>B</b> mm
<b>11</b>	24	190	60
<b>24</b>	36	204	60

**Art.-No.**







**4800.24**

1

**4800.36**

1



AGROflex PET Geflechschläuche Polyester AGROflex PET braided sleeveings polyester		<b>303</b>
AGROflex Box PET Geflechschläuche in Spenderboxen AGROflex Box PET braided sleeveings in dispenser boxes		<b>304</b>
AGROflex PA Geflechschläuche Polyamid AGROflex PA braided cable sleeveings polyamide		<b>305</b>
AGROsnap selbstschliessender Gewebeslauch AGROsnap self-closing braided sleeve		<b>306 - 307</b>

1

2

3

4

5

6

7

8

9

10

11

12

13

**14**

15



# AGROflex Geflechschläuche in Polyester und Polyamid

## AGROflex braided sleeves made of polyester and polyamide



In Zusammenarbeit mit namhaften Kunden haben wir die Produkteigenschaften erarbeitet, welche für den Anwender besonders wichtig sind und versucht, diese Kriterien zusammen mit Produktionstechnikern in verbesserte Produkte umzusetzen.

Die bemerkenswerteste Änderung ist der spitzere Flechtwinkel, in welchem die Einzelfäden miteinander verwoben sind. Diese neue Flechtweise kombiniert mit einem etwas dünneren Monofil bei der Ausführung in Polyester führt zu einem extrem flexiblen Schlauch und zu einer hervorragenden Aufstauchbarkeit. Die Geflechte lassen sich auf das Doppelte ihrer Nennweite aufstauchen.

Der spitzere Flechtwinkel erlaubt ein geschmeidigeres Einführen von Leitungen und Kabeln auch über grössere Längen. Die Einzelfilamente laufen sozusagen parallel zu den Kabeln und stellen sich ihnen nicht als Hindernis oder „Einfädelstelle“ in den Weg.

### Wichtigste Eigenschaften

- Hochflexibel
- Aufstauchverhältnis 1:2
- Gute Laugen- und Säurenbeständigkeit
- Geprüft nach EN 45545-2 Hazard Level 3

In cooperation with our well-known customers, we have defined the product properties which are especially important for the user and have worked with our production engineers to translate these criteria into improved products.

The most notable change is the more pointed braid angle with which the individual strands are woven together. This new way of braiding, combined with a slightly thinner monofilament in the polyester version, results in an extremely flexible sleeving and in outstanding stretching qualities. The braiding can stretch to twice its nominal width.

The more pointed braid angle permits smoother insertion of power cords and cables, even across long distances. The individual strands run more parallel to the cable and do not obstruct or “catch” the cable.

### Key properties

- Extremely flexible
- Shortening/expansion ratio 1:2
- High resistance to acids and alkaline substances
- Tested according to EN 45545-2 Hazard Level 3

Material: Polyester PET  
 Monofil: Ø 0.22mm  
 Eigenschaften: Hochflexibel, selbstanpassend, abriebfest, frei von Cadmium, Formaldehyd, Halogen und Graphit, selbstverlöschend nach DIN 75200 (FMVSS 302), gute Beständigkeit gegen Kraftstoffe, Mineralöle und Chemikalien

Aufweitung: Aufstauchverhältnis 1 : 2  
 Zulassung: EN 45545-2 (HL3)  
 Einsatztemperatur: -50 °C / +150 °C

Material: Polyester PET  
 Monofil: Ø 0.22mm  
 Properties: Highly flexible, self-adapting, resistant to abrasion, free of cadmium, formaldehyde, halogen and graphite, self-extinguishing acc. to DIN 75200 (FMVSS 302), good resistance to fuel, mineral oil and chemicals

Expansion: Expansion ratio 1 : 2  
 Approval: EN 45545-2 (HL3)  
 Operation temperature: -50 °C / +150 °C

Polyester PET Schwarz matt				Polyester PET Black matt	
NW	Ø min mm	Ø max mm	OFB %	Art.-No.	
3	2	6	86	6875.40.03	200
5	4	10	89	6875.40.05	200
8	7	15	81	6875.40.08	150
10	8	20	79	6875.40.10	150
15	13	25	81	6875.40.15	100
20	16	28	77	6875.40.20	100
24	24	38	82	6875.40.24	100
36	35	65	78	6875.40.36	100
50	45	80	82	6875.40.50	100

OFB = Oberflächendeckung  
 Auf Anfrage lieferbar:  
 Verpackungseinheiten auf Grossrollen

OFB = Percentage of the surface covered by fabric  
 Available on request:  
 Packaging units on large rolls



AGROflex PET



Polyester PET Grau matt				Polyester PET Grey matt	
NW	Ø min mm	Ø max mm	OFB %	Art.-No.	
3	2	7	86	6875.70.03	200
5	4	10	89	6875.70.05	200
8	7	15	81	6875.70.08	150
10	8	20	79	6875.70.10	100
15	13	25	81	6875.70.15	100
20	16	28	77	6875.70.20	100
24	24	38	82	6875.70.24	100
36	35	65	78	6875.70.36	300
50	45	80	82	6875.70.50	100

OFB = Oberflächendeckung  
 Auf Anfrage lieferbar:  
 Verpackungseinheiten auf Grossrollen

OFB = Percentage of the surface covered by fabric  
 Available on request:  
 Packaging units on large rolls



AGROflex PET



# AGROflex Box PET Geflechschlauch in Spenderbox

## AGROflex Box PET braided sleeving in dispenser box

### Geflechschlauch für Elektrofahrzeuge | Braided sleeving for electric vehicles

Material: Polyester PET  
 Monofil: Ø 0.25mm  
 Eigenschaften: Hochflexibel, selbstanpassend, abriebfest, frei von Cadmium, Formaldehyd, Halogen und Graphit, selbstverlöschend nach DIN 75200 (FMVSS 302), gute Beständigkeit gegen Kraftstoffe, Mineralöle und Chemikalien

Aufweitung: Aufstauchverhältnis 1 : 2  
 Einsatztemperatur: -55 °C / +150 °C

Material: Polyester PET  
 Monofil: Ø 0.25mm  
 Properties: Highly flexible, self-adapting, resistant to abrasion, free of cadmium, formaldehyde, halogen and graphite, self-extinguishing acc. to DIN 75200 (FMVSS 302), good resistance to fuel, mineral oil and chemicals

Expansion: Expansion ratio 1 : 2  
 Operation temperature: -55 °C / +150 °C



Orange				Orange	
NW	Ø min mm	Ø max mm	OFB %	Art.-No.	
5	4	10	89	6875.80.05	100
8	6	11	85	6875.80.08	100
10	8	14	84	6875.80.10	100
12	10	16	88	6875.80.12	100
16	14	24	86	6875.80.16	100
20	18	25	88	6875.80.20	100
25	18	33	87	6875.80.25	100
35	30	52	85	6875.80.35	100
45	38	60	85	6875.80.45	100

Farbe Orange für Elektrofahrzeuge  
 OFB = Oberflächendeckung

Colour orange for electric vehicles  
 OFB = Percentage of the surface covered by fabric

### Spenderbox für Service und Unterhalt | Dispenser box for service and maintenance

Material: Polyester PET  
 Monofil: Ø 0.22mm  
 Eigenschaften: Hochflexibel, selbstanpassend, abriebfest, frei von Cadmium, Formaldehyd, Halogen und Graphit, selbstverlöschend nach DIN 75200 (FMVSS 302), gute Beständigkeit gegen Kraftstoffe, Mineralöle und Chemikalien

Aufweitung: Aufstauchverhältnis 1 : 2  
 Zulassung: EN 45545-2 (HL3)  
 Einsatztemperatur: -50 °C / +150 °C

Material: Polyester PET  
 Monofil: Ø 0.22mm  
 Properties: Highly flexible, self-adapting, resistant to abrasion, free of cadmium, formaldehyde, halogen and graphite, self-extinguishing acc. to DIN 75200 (FMVSS 302), good resistance to fuel, mineral oil and chemicals

Expansion: Expansion ratio 1 : 2  
 Approval: EN 45545-2 (HL3)  
 Operation temperature: -50 °C / +150 °C



Schwarz				Black	
NW	Ø min mm	Ø max mm	i info	Art.-No.	
5	3	10	12 m	6875.40.05.10	1
10	8	20	12 m	6875.40.10.10	1
18	18	27	6 m	6875.40.18.06	1
30	23	50	6 m	6875.40.30.06	1

# AGROflex PA Geflechschläuche Polyamid

## AGROflex PA braided cable sleeves polyamide

Material:	Polyamid PA 6	Material:	Polyamide PA 6
Monofil:	Ø 0.25mm	Monofil:	Ø 0.25mm
Eigenschaften:	Hochflexibel, selbstanpassend, abriebfest, frei von Cadmium, Formaldehyd, Halogen und Graphit, selbstverlöschend nach DIN 75200 (FMVSS 302), gute Beständigkeit gegen Kraftstoffe, Mineralöle und Chemikalien	Properties:	Highly flexible, self-adapting, resistant to abrasion, free of cadmium, formaldehyde, halogen and graphite, self-extinguishing acc. to DIN 75200 (FMVSS 302), good resistance to fuel, mineral oil and chemicals
Aufweitung:	Aufstauchverhältnis 1 : 2	Expansion:	Expansion ratio 1 : 2
Einsatztemperatur:	-55 °C / +125 °C	Operation temperature:	-55 °C / +125 °C

Schwarz				Black		
NW	Ø min mm	Ø max mm	OFB %	Art.-No.		
3	2.5	6.0	85	6850.40.03	100	
4	3.0	8.5	91	6850.40.04	100	
5	4.0	10.0	95	6850.40.05	100	
6	4.0	9.0	85	6850.40.06	100	
10	7.0	16.0	90	6850.40.10	100	
12	9.0	17.0	94	6850.40.12	100	
16	14.0	26.0	87	6850.40.16	100	
22	18.0	30.0	84	6850.40.22	100	
24	20.0	35.0	82	6850.40.24	100	
30	26.0	40.0	88	6850.40.30	100	
35	28.0	40.0	88	6850.40.35	100	
45	38.0	58.0	84	6850.40.45	100	
50	35.0	80.0	88	6850.40.50	100	
70	55.0	80.0	91	6850.40.70	100	

OFB = Oberflächendeckung	OFB = Percentage of the surface covered by fabric
Grau auf Anfrage	Colour grey on request



# AGROsnap selbstschliessender Gewebeslauch

## AGROsnap self-closing braided sleeve

### für nachträgliche Installation | for additional installation

Material:	Monofil Polyester PET mit Multifil-Fasern	Material:	Monofil polyester PET with multifilament fibres
Monofil:	Ø 0.25mm	Monofil:	Ø 0.25mm
Einsatzbereich:	Problemloses Einziehen von vorkonfektionierten Kabeln, für nachträgliche Installation	Application:	Sinking of pre-connected cables without problems, for additional installation
Eigenschaften:	Hochflexibel, selbstanpassend, abriebfest, frei von Cadmium, Formaldehyd, Halogen und Graphit, selbstverlöschend nach DIN 75200 (FMVSS 302), gute Beständigkeit gegen Kraftstoffe, Mineralöle und Chemikalien	Properties:	Highly flexible, self-adapting, resistant to abrasion, free of cadmium, formaldehyde, halogen and graphite, self-extinguishing acc. to DIN 75200 (FMVSS 302), good resistance to fuel, mineral oil and chemicals
Zertifikat:	EN 45545-2 / NFPA 130	Certificate:	EN 45545-2 / NFPA 130
Ausführung:	gebündelter Wickelstrang	Execution:	bundled winding strand
Einsatztemperatur:	-55 °C / +150 °C	Operation temperature:	-55 °C / +150 °C



Schwarz			Black	
NW	Ø min mm	Ø max mm	Art.-No.	
5	3	5	6879.40.05	50
8	5	8	6879.40.08	50
10	8	10	6879.40.10	50
13	10	13	6879.40.13	50
16	13	16	6879.40.16	50
19	16	19	6879.40.19	25
25	22	25	6879.40.25	25
29	26	29	6879.40.29	25
32	29	32	6879.40.32	25
38	35	44	6879.40.38	25
50	44	50	6879.40.50	25

Nominaler Innendurchmesser mit einer Überlappung von 25% / 90°      Nominal inner diameter with 25% / 90° overlap

Auf Anfrage lieferbar:      Available on request:  
Farbe Orange für Elektrofahrzeuge      Colour orange for electric vehicles



# AGROsnap selbstschliessender Gewebeslauch

## AGROsnap self-closing braided sleeve

für nachträgliche Installation | for additional installation

Material:	Monofil Polyester PET mit Multifil-Fasern	Material:	Monofil polyester PET with multifilament fibres
Monofil:	Ø 0.25mm	Monofil:	Ø 0.25mm
Einsatzbereich:	Problemloses Einziehen von vorkonfektionierten Kabeln, für nachträgliche Installation	Application:	Sinking of pre-connected cables without problems, for additional installation
Eigenschaften:	Hochflexibel, selbstanpassend, abriebfest, frei von Cadmium, Formaldehyd, Halogen und Graphit, selbstverlöschend nach DIN 75200 (FMVSS 302), gute Beständigkeit gegen Kraftstoffe, Mineralöle und Chemikalien	Properties:	Highly flexible, self-adapting, resistant to abrasion, free of cadmium, formaldehyde, halogen and graphite, self-extinguishing acc. to DIN 75200 (FMVSS 302), good resistance to fuel, mineral oil and chemicals
Ausführung:	gebündelter Wickelstrang	Execution:	bundled winding strand
Einsatztemperatur:	-55 °C / +150 °C	Operation temperature:	-55 °C / +150 °C

Orange			Orange	
NW	Ø min mm	Ø max mm	Art.-No.	
8	5	8	6879.80.08	50
13	10	13	6879.80.13	50
16	13	16	6879.80.16	50
19	16	19	6879.80.19	25
25	22	25	6879.80.25	25
29	26	29	6879.80.29	25
32	29	32	6879.80.32	25
38	35	44	6879.80.38	25
50	44	50	6879.80.50	25

Farbe Orange für Elektrofahrzeuge  
Nominaler Innendurchmesser mit einer Überlappung von 25% / 90°

Colour orange for electric vehicles  
Nominal inner diameter with 25% / 90° overlap





- AGRO online
- Dynamische Produktsuche
- Merkliste
- Produktvergleich
- 3D-Ansicht
- CAD-Download
- Anfragefunktion

- AGRO online
- Dynamic product searching
- Memo list
- Product comparison
- 3D views
- CAD download
- Inquiry function

Auf unserer Website [www.agro.ch](http://www.agro.ch) bieten wir Ihnen **umfangreiche Informationen**. Dank der **benutzerfreundlichen Navigation** und der **dynamischen Suchfunktionen** finden Sie die zu Ihrer Anwendung passenden Kabelverschraubungen hier in Sekundenschnelle. Die **Produktansicht** zeigt alle technischen Daten sowie Zulassungen auf einen Blick. Aus jeder Produktansicht können Sie ein **Produktdatenblatt im PDF-Format** generieren. Die gewählten Produkte können Sie in einer **Merkliste** speichern, welche eine Vielfalt an Funktionen bietet – z. B. Produktvergleich, Medien-Download oder Anfrageformular. Die **CAD-Daten** zu allen Kabelverschraubungen sind online hinterlegt. Diese können entweder in einer dynamisch generierten **3D-Ansicht** angezeigt werden oder lassen sich in allen gängigen CAD-Formaten an die eigene E-Mail-Adresse senden. Wir freuen uns auf Ihren virtuellen Besuch auf unserer Website!

You can find **comprehensive information** on our website, [www.agro.ch](http://www.agro.ch). The **user-friendly navigation** and the **dynamic search functions** enable you to find the products you need for your application in just a few seconds. The **product overview** for each product shows all the technical information including technical approvals at a glance. You can generate a **pdf-format product data sheet** from every product overview. In addition, you can save the products you need for your application in a **memo list** which gives you a wide range of functions, for example product comparisons, media download or an inquiry form. We have put online the **CAD data** on all cable glands. The data can be displayed as a dynamically-generated **3D view** or can be sent to an email address in all standard CAD formats. We look forward to your virtual visit to our website!



YouTube

#### Neu: Produkt-Animationen für Ihr Smartphone

Der QR-Code ermöglicht Ihnen einen schnellen und bequemen Zugriff auf unsere informativen Produkt-Animationen mit Ihrem Smartphone. Probieren Sie es aus!

#### New: Product animations for your smartphone

The QR code gives you fast, easy access to our informative product animations via your smartphone. Try it - you'll like it!



Spezielle Einführungslösungen Special entry solutions	310 - 311	1
Prüfzeichen Certification marks	312 - 313	2
Brandschutz für Schienenfahrzeuge nach EN 45545 Fire protection for railway vehicles according to EN 45545	314 - 315	3
Progress® Baukasten und AGRO Sonderlösungen Progress® Modular assembly system and AGRO special solutions	316 - 321	4
AGRO Prüftechnik AGRO Test laboratory	322 - 325	5
Sonderlösung für very heavy duty Special solution for "very heavy duty" application	326	6
Montageanleitungen Kabelverschraubungen Assembly instructions for cable glands	327 - 332	7
Gewindetabelle Threads table	333	8
Verzeichnis der Schutzarten (IP) List of Protection Classes (IP)	334	9
Materialübersichtstabellen Materials overview	335 - 338	10
Vergleich rostfreier und säurebeständiger Stahl A4 Comparison of A4 stainless and acid-resistant steels	339	11
Suchhilfen Search help	340 - 364	12

## Spezielle Einführungs-lösungen Special entry solutions



### **AGRO Kabelverschraubungen – die Alleskönner**

Unser Standard-Sortiment an Kabelverschraubungen ist darauf ausgerichtet, ideale Einführungs-lösungen für Standardapplikationen zu bieten.

In manchen spezifischen Situationen muss die Kabelverschraubung den konkreten Anforderungen angepasst werden. Sehr oft ist es ausreichend, die Bestandteile des Progress® Baukastens individuell zusammenzustellen, um eine passende Lösung zu finden. Alle Einzelkomponenten des Baukastens sind kompatibel und können frei kombiniert werden.

Manche Montagesituationen oder Anforderungen sind jedoch besonders und es muss eine spezifische Einführungs-lösung gefunden werden. Auch für diesen Fall bietet der Progress® Baukasten die notwendige Flexibilität für schnelle und kostengünstige Einzelanfertigungen.

Kabelverschraubungen können auf jeder Stufe des Baukastens den Anforderungen entsprechend individualisiert werden.

Wir können alle technischen Gewinde in verschiedenen Materialien umsetzen und Dichteinsätze im Hinblick auf Anzahl, Form der Durchführungen und Materialwahl so individualisieren, dass den Anforderungen genau entsprochen wird. Langfristige Funktionssicherheit ist das oberste Ziel.

Sprechen Sie mit uns, wenn Sie Kabel in Ihr Gerät einführen müssen. Wir finden eine einfachere, rationellere oder schönere Lösung für Sie!

### **AGRO cable glands – the all-rounders**

Our standard range of cable glands is designed to provide ideal cable entry solutions for standard applications.

In some specific situations, the cable gland must be adapted to special requirements. It is often possible to find a suitable solution simply by assembling the Progress® system's components in an appropriate way. All individual components of the system are compatible and can be easily combined.

However, in some cases, a special cable entry solution must be developed. In this case too, the modular design of the Progress®-system enables any single component of the cable gland to be customised individually, making the process fast and cost-effective.

We can supply cable glands with any required thread type, in various materials and customise sealing inserts in terms of material and of number and shape of cable entries in order to meet all requirements. Long-term reliability is the top priority.

Contact us, if your equipment needs cable entries. We will find a nicer, simpler or more efficient solution for you!

# Zwei Klemmtechnologien für alle Anforderungen

## Two clamping technologies for all requirements

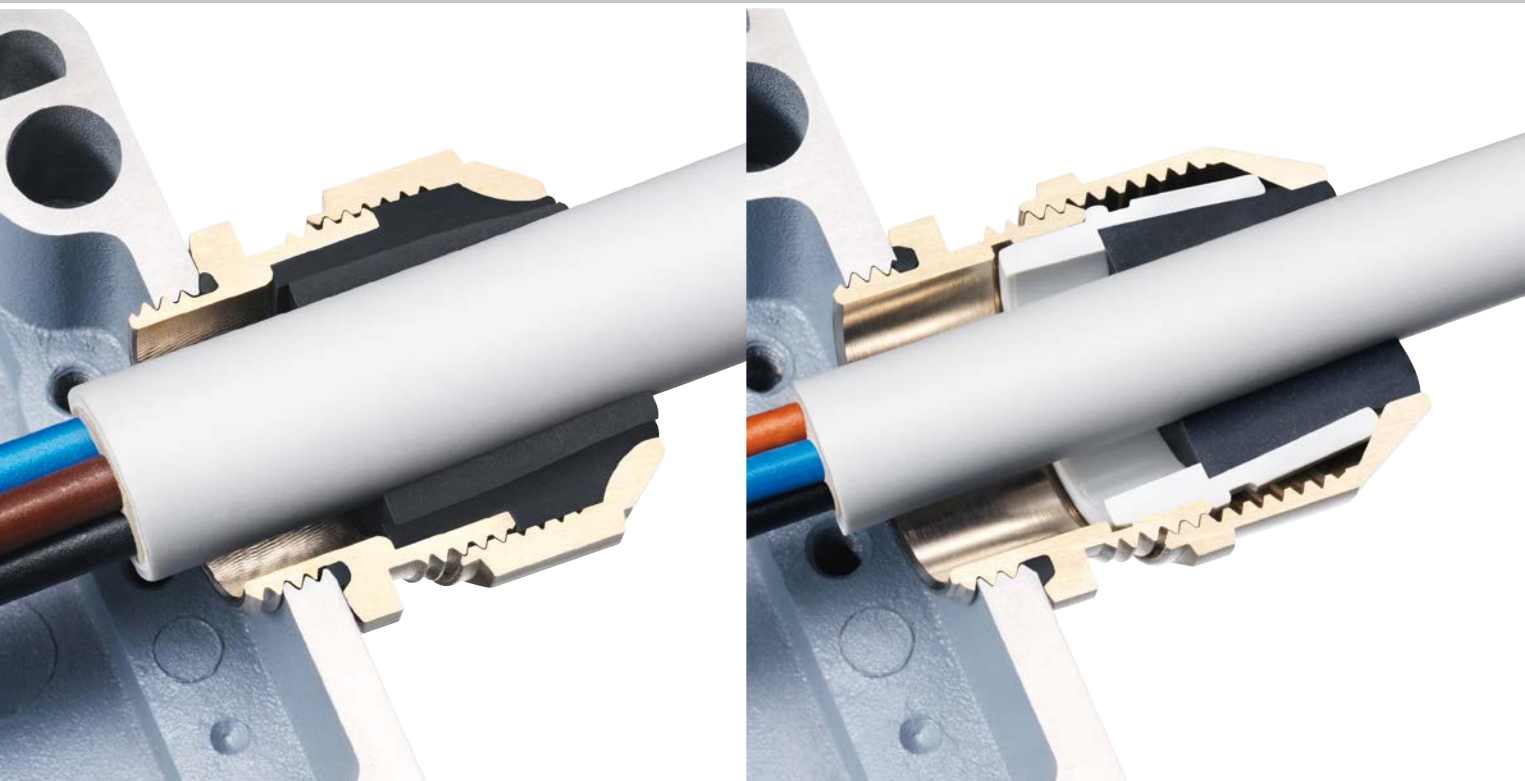

### Progress® in Messing, Stahl oder Kunststoff

AGRO Kabelverschraubungen Progress® mit herausragender Kompressionstechnik sorgen für eine hohe Dichtigkeit und eine äusserst kabelschonende Zugentlastung auch bei dynamischen Belastungen. Dichteinsätze für spezifische Anwendungen wie Bahnapplikationen nach EN 45545, im Trinkwasserbereich, in der Lebensmittel- und Reinraumtechnologie oder bei hohen Temperaturen sind standardmässig verfügbar.

- 1 Kurze, lange oder Spezial-Anschlussgewinde in metrischer, Pg-, Gasrohr- oder NPT-Ausführung
- 2 Hoher Verdrehenschutz dank Längsrandrierung im Dichteinsatz
- 3 Zweiteilige Dichteinsätze erweitern den Klemmbereich
- 4 Auf den Dichteinsatz abgestimmte Innenkonturen sorgen für eine zielgerichtete Verformung des Dichteinsatzes und garantieren die Schutzart IP 68 bis 10 bar sowie IP 69



### Progress® in brass, steel or synthetic material

The outstanding compression technology of AGRO Progress® cable glands ensures effective sealing and excellent cable-protecting strain relief, also for dynamic loads. Sealing inserts for special applications such as railway (EN 45545), drinking water, food industry, cleanroom and high-temperature applications are available as standard.

- 1 Short, long or special entry threads (metric, PG, gas pipe or NPT)
- 2 High anti-rotation protection thanks to longitudinal grooves in the sealing insert
- 3 Two-piece sealing inserts for larger clamping range
- 4 Inner contours matched to the sealing insert cause the desired deformation ensuring sealing performance in compliance with protection class IP 68 up to 10 bar and IP 69

### Syntec® in Messing oder Kunststoff

Kabelverschraubungen Syntec® sind mit ihrer innovativen Lamellentechnik speziell geeignet für den flexiblen und sicheren täglichen Einsatz. Die Vorfixierung der Kunststoff-Druckmutter erleichtert Überkopf-Montagen.

- 1 Kurze oder lange Anschlussgewinde in metrischer, Pg- oder NPT-Ausführung
- 2 Elastische und umweltbeständige Dichtringe garantieren die Schutzart IP 68
- 3 Die Lamellengeometrie mit beweglichen Gelenklamellen ermöglicht das Einführen verschiedener Kabeldurchmesser bei hervorragender Zugentlastung und exzellentem Verdrehenschutz
- 4 Der grossflächige Sechskant der Druckmutter der Kunststoffausführungen bietet sicheren und festen Halt



### Syntec® in brass or synthetic material

Syntec® cable glands with their innovative lamellar technology are particularly suitable for flexible, reliable everyday use. The pre-fixation of the synthetic compression nut facilitates easy over-head installation.

- 1 Short or long entry threads (metric, PG or NPT)
- 2 Elastic and environmentally resistant sealing rings ensure protection class IP 68
- 3 Lamellar technology for cable gripping facilitates the insertion of cables of varying diameters and ensures outstanding strain relief and anti-rotation protection
- 4 The large-area hexagonal surface of the compression nut of the plastic version offers reliable and secure grip



### SEV

Das SEV-Konformitätszeichen wird auf Grund bestandener Prüfungen von Eurofins E&E erteilt. Grundlage für Kabelverschraubungen ist hierbei die europäische Norm EN 62444.

### SEV

The SEV conformity mark is awarded on the basis of tests conducted by Eurofins E&E. European standard EN 62444 forms the basis for cable glands.



### VDE

Das VDE-Zeichen kennzeichnet die Konformität mit den VDE-Bestimmungen bzw. europäischen oder international harmonisierten Normen und bestätigt die Einhaltung der Schutzanforderungen der zutreffenden Richtlinien. Das VDE-Zeichen steht für die Sicherheit des Produktes hinsichtlich elektrischer, mechanischer, thermischer und sonstiger Gefährdung.

### VDE

The VDE certification mark signals conformity with the VDE provisions and European or internationally harmonised standards and confirms compliance with the protection requirements of the applicable guidelines. The VDE mark signifies the safety of the product in terms of electrical, mechanical, thermal and other hazards.



### UKCA

Die UKCA-Kennzeichnung (UK Conformity Assessed) ist die neue Produktkennzeichnung, die verwendet werden muss, um nachzuweisen, dass bestimmte Waren den neuen Vorschriften des Vereinigten Königreichs entsprechen. Sie dient als Nachweis der Konformität bestimmter Waren mit den gesetzlichen Anforderungen des Vereinigten Königreichs und wird beim Inverkehrbringen dieser Waren in Großbritannien verwendet. Sie gilt für alle Waren, für die bisher eine CE-Kennzeichnung erforderlich war.

### UKCA

The UKCA (UK Conformity Assessed) mark is the new product labelling that must be used to verify that certain goods comply with the United Kingdom's new regulations. It serves as proof of compliance of certain goods with the UK's legal requirements and is applied when placing these goods on the market in Great Britain. It applies to all goods for which a CE marking was previously required.



### C-UL / US Listing Zeichen

Dieses Prüfzeichen wird bei Produkten verwendet, die auf kanadischen und U.S.-Märkten vertrieben werden. Es weist darauf hin, dass die kanadischen und die U.S.-Anforderungen für klassifizierbare Produkte erfüllt wurden.

### C-UL / US Listing Mark

This approval mark is used for products that are sold in the US and Canadian markets. It indicates that the US and Canadian requirements for classifiable products have been fulfilled.



### Recognized Component Zeichen für Kanada und die USA

Das Recognized Component Mark von UL darf für Komponenten verwendet werden, die Bestandteil eines grösseren Produktes oder Systems sind. Diese sind von UL gemäss kanadischen und U.S.-Anforderungen zertifiziert.

### Recognized Component Mark for Canada and the USA

The UL Recognized Component Mark can be used for components that are part of a larger product or system. These are certified by UL in accordance with US and Canadian requirements.



### CCC

CCC steht für China Compulsory Certificate. Das chinesische CCC ist vergleichbar mit anderen Zertifizierungen zur Standardisierung der Produktqualität. Im Rahmen der Zertifizierung werden Produkttests und Werksaudits durchgeführt. Die CCC-Zertifizierung basiert auf den nationalen, chinesischen GB Standards und Durchführungsbestimmungen (Implementation Rules). Die zertifizierungspflichtigen Produkte dürfen erst nach China importiert, in China verkauft und in Geschäftsaktivitäten in China verwendet werden, nachdem eine CCC-Zertifizierung des Produktes beantragt und erteilt wurde.

### CCC

CCC stands for China Compulsory Certificate. The Chinese CCC is comparable to other certifications used to standardise product quality. Product tests and factory audits are carried out as part of the certification. The CCC certification is based on the national Chinese GB standards and implementation rules. The products subject to certification may only be imported into China, sold in China, and used in business activities in China, after a CCC certification of the product has been applied for and granted.

**Det Norske Veritas (DNV)**

Det Norske Veritas (DNV) ist eine Schiffsklassifikations-Gesellschaft in Form einer Stiftung. Sie klassiert und erteilt Zertifikate zum unbedenklichen Einsatz von Produkten auf Schiffen. DNV wurde 1864 in Oslo gegründet.

**Det Norske Veritas (DNV)**

Det Norske Veritas (DNV) is a ship classification society in the form of a foundation. It classifies and issues certificates relating to the safe use of products on ships. DNV was founded in Oslo in 1864.



1

**IEC Ex**

Das IEC Ex / ATEX-Prüfzeichen ist eine spezielle Kennzeichnung für Explosionsschutz-Einrichtungen. Es bedeutet, dass Einrichtungen, Schutzsysteme oder Bauteile den Anforderungen der internationalen und europäischen Norm entsprechen, die mit der Richtlinie 2014/34/EU (ATEX-Direktive, benannt nach der französischen Bezeichnung „ATmosphere EXplosible“) harmonisiert sind.



2

**IEC Ex**

The IEC Ex / ATEX mark of conformity is a special marking for equipment used in explosive atmospheres. It means that equipment, protective systems or components meet the requirements of the international and European standards which are harmonised with Directive 2014/34/EC (the ATEX directive, named after the French “ATmosphere EXplosible” certification).

4

**RoHS**

„Restriction of the use of certain Hazardous Substances in electronic equipment“ ist der Titel der EU-Richtlinie 2002/95/EG. Sie verbietet ab 1.7.2006 im gesamten Gebiet der EU den Verkauf von elektrischen Geräten, welche mehr als nur Spuren von Blei, Cadmium, Chrom VI, Quecksilber oder von polybromierten Flammschutzmitteln PBB/PBDE enthalten.

**RoHS**

5

**RoHS**

“Restriction of the use of certain Hazardous Substances in electronic equipment“ is the title of EC Directive 2002/95/EC. With effect from 1 July 2006, it forbids the sale of electric equipment which contain more than traces of lead, cadmium, chromium(VI), mercury or polybrominated flame retardants (PBBs and PBDEs) throughout the entire EC.

6

**REACH**

Die Verordnung (EG) Nr. 1907/2006 (REACH-Verordnung) ist eine EU-Chemikalienverordnung, die am 1. Juni 2007 in Kraft getreten ist. REACH steht für Registration, Evaluation, Authorisation and Restriction of Chemicals. Das REACH-System basiert auf dem Grundsatz der Eigenverantwortung der Industrie. Innerhalb des Geltungsbereiches dürfen nur noch chemische Stoffe in Verkehr gebracht werden, die vorher registriert worden sind.



8

**REACH**

Regulation (EC) No. 1907/2006 (REACH Regulation) is an EU chemicals regulation that came into force on June 1st, 2007. REACH stands for Registration, Evaluation, Authorisation and Restriction of Chemicals. The REACH system is based on the principle of self-responsibility of the industry. Within the regulation’s scope, only chemical substances that have been already registered may be placed on the market.

9

**EN 45545**

Die EN 45545 setzt sich aus mehreren Teilen zusammen und definiert den Brandschutz in Schienenfahrzeugen. Teil 1 umfasst allgemeine Regeln, Teil 2 (EN 45545-2) ist in Bezug auf gefährliche Rauchgase sehr wichtig und Teil 3 (EN 45545-3) definiert den Feuerwiderstand von Feuerschutzabschlüssen (Raumabschlüsse).

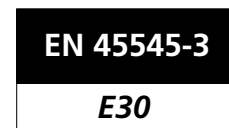

10

11

**EN 45545**

The EN 45545 standard consists of several parts and specifies rules relating to fire protection of railway vehicles. Part 1 covers general requirements, part 2 (EN 45545-2) is very important in relation to dangerous smoke gases and part 3 (EN 45545-3) defines the fire resistance requirements for fire barriers.

12

**NFPA**

Die amerikanische Norm NFPA 130 definiert die zulässigen Werte für die Wärmefreisetzung und Rauchentwicklung (ASTM E 1354) sowie die Rauchgas-Toxizität (SMP 800) für Produkte, welche in Schienenfahrzeugen zur Anwendung kommen.



13

**NFPA**

The American standard NFPA 130 specifies permitted values for heat release and smoke emission (ASTM E 1354) as well as smoke toxicity (SMP 800) of products for use in rolling stock applications.

14

# AGRO Kabelverschraubungen sind nach EN 45545-2 zertifiziert

## AGRO cable glands are certified according to EN 45545-2

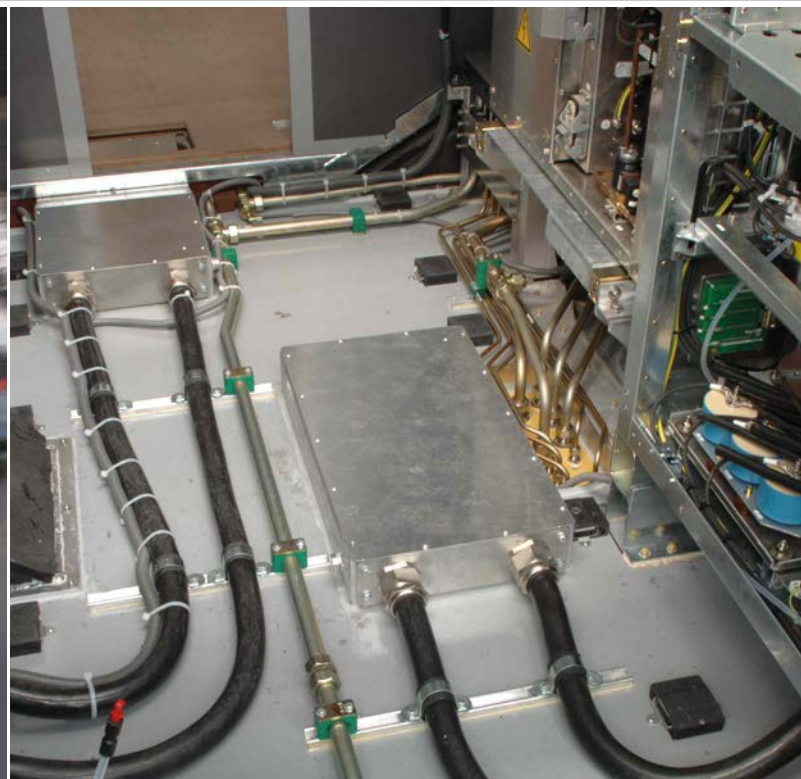

### AGRO Progress® bedenkenlos für Schienenfahrzeuge

AGRO Progress® Kabelverschraubungen aus Metall können bedenkenlos für alle Anwendungen und Anordnungen im Schienenfahrzeugbereich eingesetzt werden. Dies bescheinigt das neue Zertifikat.

Die herausragende Progress® Kompressionstechnik sorgt für eine hohe Dichtigkeit und eine äusserst kabelschonende Zugentlastung auch bei dynamischen Anwendungen. Standard- und EMV-Kabelverschraubungen mit dem entsprechenden Zubehör bilden das Basissortiment für nahezu alle Anwendungen. AGRO fertigt bei Bedarf auch zertifizierte Lösungen gemäss Anforderungen der Kunden.

### Beste Resultate bei Prüfungen nach EN 45545-2 (Komponenten)

Die Progress® Dichteinsätze sind aus einem speziellen TPE gefertigt und sind im anspruchsvollsten **Hazard Level 3** zertifiziert.

Die geforderten Werte für Hazard Level 3 wurden sowohl im Aussen- als auch im Innenbereich deutlich übertroffen:

### AGRO Progress® - the ideal solution for rolling stock

AGRO Progress® metal cable glands can be used with confidence for any rolling stock application, in any arrangement, as has been recently certified.

The outstanding Progress® compression technology ensures tight seals and offers cables exceptional damage-preventing strain relief, even in dynamic applications. A comprehensive range of standard and EMC cable glands and accessories offers a solution for almost any application. Where the need arises, AGRO also delivers certified solutions according to customer requirements.

### Best results in testing according to EN 45545-2 (Components)

The seal inserts of Progress® cable glands are made from a special TPE and certified to the demanding **Hazard Level 3**.

The stipulated values for Hazard Level 3 were exceeded, for both indoor and outdoor areas:

	Normwert für HL 3 aussen Requirement for HL 3 outdoor	Normwert für HL 3 innen Requirement for HL 3 indoor	AGRO Resultat AGRO result
Sauerstoffindex   Oxygen index	Min. 32%	Min. 32%	<b>39%</b>
Rauchgasdichte Ds   Smoke gas density Ds	Max. 300	Max. 150	<b>110</b>
Toxizität CIT   Toxicity CIT	Max. 1.5	Max. 0.75	<b>0.37</b>

### Kabelverschraubungen zertifiziert für den Einsatz in Schienenfahrzeugen

#### Cable glands certified for rolling stock applications



**Material:** Messing vernickelt  
**Material Dichteinsatz:** Spezial AGRO TPE  
**Farbe Dichteinsatz:** Hellgrau RAL 7035  
**Gewinde:** M12 bis M63  
Pg 7 bis Pg 48  
**Einsatztemperatur:** -50°C / +105°C  
**Schutzart:** IP 68 / IP 69 K  
**Weitere Normen:** EN 62444

**Material:** Nickel-plated brass  
**Material of sealing insert:** Special AGRO TPE  
**Colour of sealing insert:** Light grey RAL 7035  
**Threads:** M12 to M63  
Pg 7 to Pg 48  
**Temperature range:** -50°C / +105°C  
**Protection class:** IP 68 / IP 69 K  
**Further standards:** EN 62444



# AGRO Kabelverschraubungen sind nach EN 45545-3 zertifiziert

## AGRO cable glands are certified according to EN 45545-3

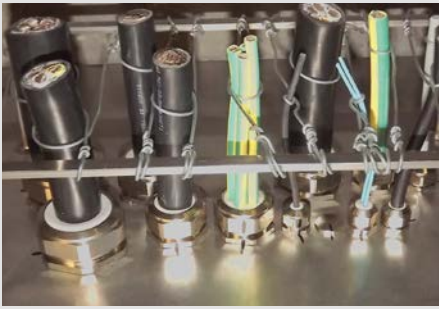

Ausgangssituation / initial situation



nach 10 min. / after 10 min.



nach 20 min. / after 20 min.



nach 30 min. / after 30 min.



nach 35 Minuten / after 35 min.



nach 44 min. / after 44 min.

### Vorgaben der EN 45545-3 übertroffen!

Die EN 45545-3 definiert die Anforderungen an den Feuerwiderstand für Feuerschutzabschlüsse. Ziel der EN 45545-3 ist es, die Brandausbreitung durch Materialanforderungen zu begrenzen. Wenn Kabel durch Feuerschutzabschlüsse geführt werden, gelten diese Anforderungen auch für Kabelverschraubungen.

Um festzustellen, ob der geforderte Feuerwiderstand erreicht wird, werden die Komponenten in einem Prüfofen in Hinblick auf die Kriterien Raumabschluss, Wärmedämmung und Strahlenemission geprüft.

AGRO Progress® Kabelverschraubungen aus Metall übertreffen die Vorgaben der EN 45545-3 bei weitem und erreichen die sehr hohe Feuerwiderstandsklasse E30. Dies bedeutet, dass die Kabelverschraubungen mindestens 30 Minuten lang dicht sind und einen Flammenübertrag auf die dem Feuer abgewandte Seite verhindern. Es bilden sich keine Spalten. Sie können aus brandschutztechnischer Sicht bedenkenlos in allen Schienenfahrzeugen eingesetzt werden.

### Exceeding the demands of EN 45545-3!

EN 45545-3 defines the requirements for fire resistance of fire barriers. The aim of EN 45545-3 is to limit fire spread by specifying the performance of materials and components. If cables are routed through fire barriers, the requirements apply also to the cable glands used.

In order to establish whether or not the required fire resistance is achieved, components are tested in a testing furnace with respect to requirements for fire barrier, thermal insulation and radiation emission.

AGRO Progress® metal cable glands easily exceed the requirements of EN 45545-3 and satisfy the very high demands of fire resistance class E30. This means that the cable gland remain impervious and prevent the spread of fire through the gland for at least 30 minutes. They do not crack or fissure. From a fire protection perspective, they can be used without hesitation in all railway vehicles.



EN 45545-3  
E30

	Einbaulage vertikal Vertical installation	Einbaulage horizontal Horizontal installation	Klassierung Classification
AGRO Resultat AGRO result	44 min.	41 min.	E30

Der Brandversuch wurde durchgeführt mit AGRO Progress® Kabelverschraubungen Messing vernickelt und Dichteinsätzen aus Spezial AGRO TPE, Größen M16 bis M50, sowie mit Multi-Kabelverschraubungen und Verschlusschrauben.

Fire testing was carried out using AGRO Progress® nickel-plated brass cable glands and seal inserts of Special AGRO TPE, sizes M16 to M50, and with multi-cable glands and locking plug.

# Progress®: Der Baukasten – Messing

## Progress®: Modular assembly system – nickel-plated brass

Der modulare Aufbau unserer Kernserie Progress® ist eine ihrer ganz grossen Stärken. Die Bauteile sind aufeinander abgestimmt und können frei kombiniert werden. Kundenspezifischen Anforderungen kann flexibel, pragmatisch und schnell entsprochen werden. Wir kombinieren für Sie das passende Ober- und Unterteil mit dem richtigen Dichteinsatz und finden so die effektive und effiziente Lösung für Ihre Montagesituation.

The modular design of our Progress® range is one of its great strengths. The components are designed with the others in mind, and can be freely combined with each other. Customer-specific requirements can be flexibly, practically and quickly met. We will combine the most suitable upper and lower parts with the right sealing insert for you, and thus deliver the most effective, most efficient solution for your needs.

### Standard Oberteile

#### Standard upper parts



Knickschutz  
Anti-kink spring



Klemmbacken  
Clamps



Trompete  
Trumpet-piece



Klemmbacken und Trompete  
Trumpet-piece with clamps



Schlauchverschraubung  
Conduit gland



Standard-Druckmutter  
Standard compression nut

### Standard Dichteinsätze

#### Standard sealing inserts



Kurzer ein- oder zweiteiliger Dichteinsatz in NBR, TPE, Spezial TPE nach EN 45545 oder FPM (temperaturbeständig)

Short one- or two-piece sealing insert made of NBR, TPE, special TPE according to EN 45545 or FPM (heat resistant)



Langer durchgehend isolierender Dichteinsatz in NBR, TPE, Spezial TPE nach EN 45545, ein oder zweiteilig

Long one- or two-piece overall length insulating sealing insert made of NBR, TPE or special TPE according to EN 45545



Für die gängigsten Kabeldurchmesser sind Dichteinsätze für die Durchführung mehrerer Kabel verfügbar

For the most common cable diameters, sealing inserts are available for the entry of several cables at once



### Standard Unterteile

#### Standard lower parts



mit kurzem Anschlussgewinde  
with short entry thread

- metrisch / metric
- Pg
- NPT
- Gasrohr / gas pipe



mit langem Anschlussgewinde  
with long entry thread

- metrisch / metric
- Pg
- NPT
- Gasrohr / gas pipe

Wenn die Anforderungen ganz spezifisch sind, können wir diesen auf jeder Stufe des Progress®-Baukastens mit individualisierten Komponenten gerecht werden: sowohl Drehteile als auch Dichteinsätze können optimal auf die Kundenbedürfnisse abgestimmt werden. Eine optimale Lösung bietet eine geringere Montagezeit und ein Gewinn an Sicherheit.

Where requirements are very specific, we can custom-design each individual component of our Progress® cable glands accordingly: both metal parts and sealing inserts can be tailored to optimally meet your needs, reducing installation time and enhancing reliability.

## Kundenspezifische Oberteile Customised upper parts

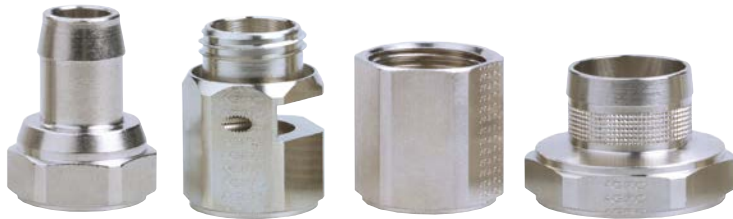

Oberteile können im Hinblick auf die Bauform und das Gewinde individualisiert werden. In Zusammenarbeit mit den Kunden wird ein Bauteil entwickelt, welches den individuellen Anforderungen am Besten entspricht und den optimalen Nutzen bietet.

Upper parts can be customised for shape and thread. By working closely with the customer, a component is developed which best meets individual requirements and optimises user benefits.

## Individualisierte Dichteinsätze Customised sealing inserts



Dichteinsätze können auf der Ebene der Form und Anzahl der Durchführungen und auf der Ebene der Materialwahl individualisiert werden. Wir bearbeiten folgende Materialien:

Sealing inserts can be customised for shape and number of feedthroughs and also with regard to the selection of material. We work with the following materials:

- NBR
- TPE-V
- FPM
- Silikonkautschuk / silicone rubber
- EPDM
- TPE
- HNBR

## Kundenspezifische Unterteile Customer-specific lower parts



Unterteile können im Hinblick auf die Bauform und das Anschlussgewinde individualisiert werden. Sämtlichen Grössen und kundenspezifischen Längen sind in folgenden Gewindearten möglich: Lower parts can be customised for shape and entry thread. All sizes and customer-specific lengths are available with the following types of thread:

- metrisch / metric
- Pg
- NPT
- Gasrohrgewinde / gas pipe

# Sonderlösung Schienenfahrzeug

## Special solutions for railway vehicles

### Die Anforderungen

- EMV-gerechte Einführung von 6 ungeschirmten Kabeln
- Verbindung Stromrichter-Trafo
- Schutzart IP 68 innen und aussen. Dadurch wird verhindert, dass Kondenswasser, welches sich möglicherweise innerhalb des Schlauches bildet, in den Traforaum eindringt

### Die Lösung von AGRO

- Progress®-Spezialverschraubung M75 mit geschlitztem Multi-Dichteinsatz zur leichteren Kabelmontage
- Kombiniert mit Metallschutzschlauch

### The requirements

- EMC-compatible feedthrough of six unshielded cables
- Connection from power rectifier to transformer
- Protection class IP68 inside and out. This prevents condensation water which could possibly build up inside the conduits from making its way into the transformer compartment

### The AGRO solution

- Progress® M75 special cable gland with splittable multi-sealing insert for easier installation
- Combined with metal conduit

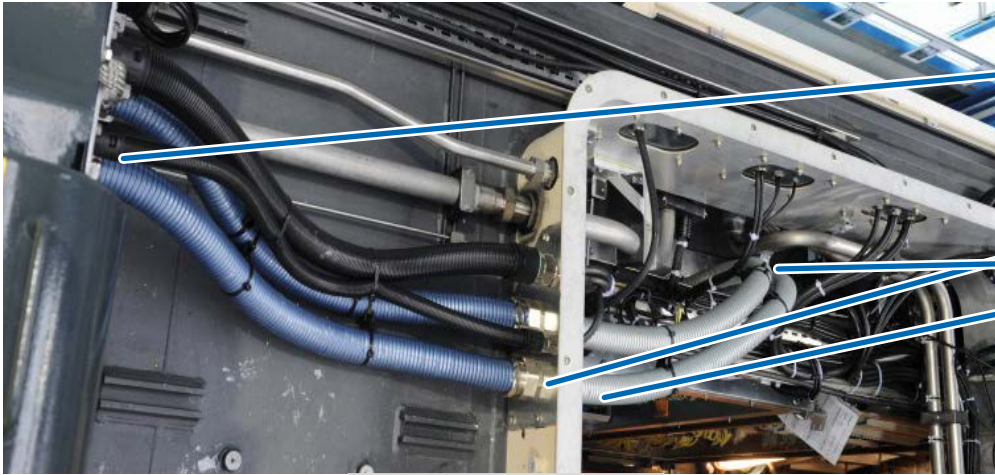

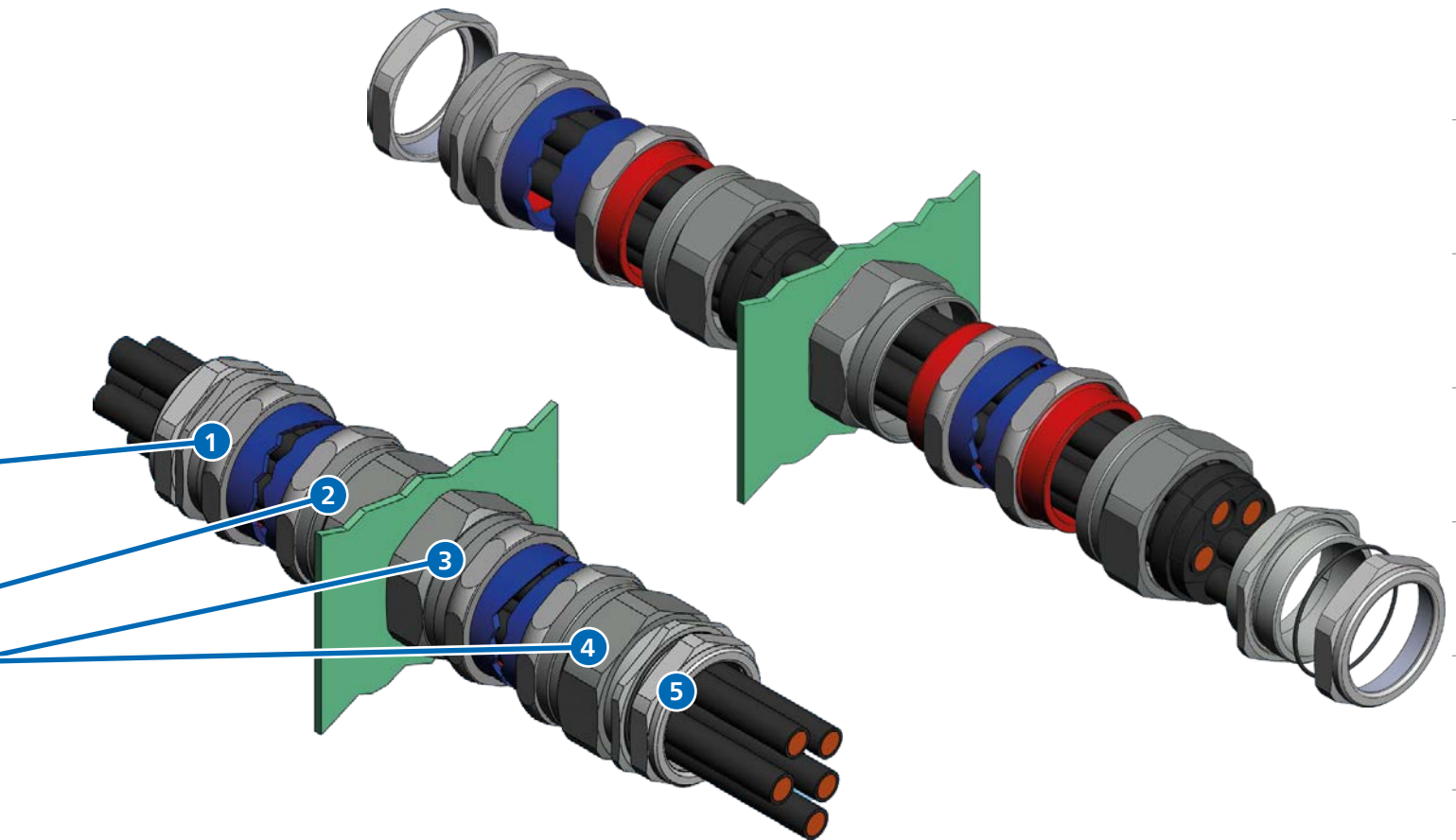

- 1 Schlauchverschraubung zur Befestigung des Metall-Kabelschutzschlauches. Innerhalb des Schutzschlauches werden sechs Stromkabel geführt. Der Metallschutzschlauch funktioniert über seine Verbindung mit den Gehäusen aus Metall als äusserer EMV-Schutz
- 2 Kombi-Schlauchverschraubung mit Progress® Multi-Dichteinsatz zur dichten Einführung der Kabel in den Traforaum (Schutz vor Feuchtigkeit von aussen)
- 3 Schlauchverschraubung zur Aufnahme des Metallschutzschlauches (Weiterführung des EMV-Schutzes)
- 4 Kombi-Schlauchverschraubung (identisch mit 2) zur Einführung der Kabel in den Trafo (Schutz vor Feuchtigkeit von innen)
- 5 Gegenmutter zur Befestigung der Kombi-Schlauchverschraubung

- 1 Conduit gland to secure the metal conduit. Six power cables are routed through the conduit. The metal conduit functions as an exterior EMC shield through its connection with the metal enclosures
- 2 Combination conduit gland with Progress® multi-sealing insert for sealed cable entry into the transformer compartment (protection from outside moisture)
- 3 Conduit gland to accept the metal conduit (extension of EMC protection)
- 4 Combination conduit gland (identical to #2) for cable entry into the transformer compartment (protection from interior moisture)
- 5 Locknut to secure the combination conduit gland

# Sonderlösung Kabelverschraubung Knabberschutz

## Rodent-proof special cable gland solution



© ABB

### Wenn Nager zum Sicherheitsrisiko werden

Manch einer kennt das Phänomen aus eigener Erfahrung: Das Auto will sich am Morgen nicht starten lassen und der Reparaturdienst stellt fest, dass Gummiteile von Mardern weggefressen worden sind.

Marder, Nager und Vögel lieben Gummi. Die Konsistenz und der Duft von Gummi zieht Kleintiere an und sie knabbern ihn an. Freigeknabberte Kabel führen zu Kurzschlüssen und Funktionsstörungen. Wenn ummantelte Kabel in einem natürlichen Umfeld eingesetzt werden, so muss mit einem Nagerschaden gerechnet werden und entsprechende Vorsichtsmaßnahmen sind sinnvoll.



Nagerschaden an Kabel /  
Rodent damage to a cable

ABB baut gasisolierte Schaltanlagen, die in der ganzen Welt unter unterschiedlichsten Umweltbedingungen eingesetzt werden. Möglichen Schäden durch Nager wird standardmässig vorgebeugt, indem die Kabel, welche Generatorschutzschalter und Steuerschrank verbinden, in einem mit Polyurethan ummantelten flüssigkeitsdichten Schlauch mit Stahlwendel geführt werden. Zur IP 68 dichten Einführung der im Schlauch geführten Kabel entwickelte AGRO in Zusammenarbeit mit ABB eine individualisierte Lösung, welche eine feuchtigkeitsdichte Verbindung von Schlauch- und Kabelverschraubung sowie einen sicheren EMV-Abgriff ermöglicht. Mit dieser Lösung werden zwei Probleme auf einmal gelöst: Die Kabelführung und -Einführung ist feuchtigkeitsdicht und vor Nagern geschützt.

### When rodents become a safety risk

Many of us know the phenomenon from personal experience: the car just won't start in the morning and the mechanic finds that rubber parts have been gnawed away by martens.

Just like martens, rodents and also birds love rubber. Small animals seem to be magically drawn to rubber by its consistency, or maybe its scent, and nibble away at it. Damaged cables can result in short circuits and loss of functionality. If shrouded cables are to be used in a natural setting, the risk of rodent damage should be recognised and appropriate precautions taken.



Nagersicherer Kabelschutz Progress® EMV Serie 85 /  
Rodent-proof cable protection Progress® EMC Serie 85

ABB manufactures gas insulated switchgear that is used all around the world in the most varying environments.

Possible damage by rodents is prevented, as standard, by the use of a polyurethane-sheathed, liquid-tight conduit with a steel coil to protect cables connecting generator circuit breakers and control cabinets. For the IP68-compliant entry of the cable in the conduit, AGRO developed, in cooperation with ABB, an individualised solution which facilitates a liquid-tight connection of conduit gland and a reliable EMC connection. This solution solves two problems at once: the cable routing and the cable entry are liquid tight, and the cable is also protected from rodents.

# Sonderlösung im längsten Eisenbahntunnel der Welt (Gotthard Basistunnel)

## Special solution in the world's longest railway tunnel (Gotthard Base Tunnel)



### Die Ausgangslage

Das Sicherheitsdispositiv im Gotthardtunnel ist hoch und sieht die permanente Überwachung der zirkulierenden Züge vor. In relativ kurzen Abständen überprüfen so genannte Achszählgeräte die Vollständigkeit des Zuges. Die Geräte sind den rauen Bedingungen im Tunnel sowie Steinschlag ausgesetzt.

### Die Anforderungen

Die stromführenden Kabel sollten mit einem schlagfesten Schlauch vor Schotterschlag geschützt werden. Die Verbindung Kabelverschraubung-Schlauch sollte auf möglichst einfache Weise erfolgen.



Progress® mit Schlauchanschluss /  
Progress® with conduit connection

### Die Lösung von AGRO

Grundlage des Lösungsansatzes bildet eine Standard Progress® Kabelverschraubung. Sie wird ergänzt durch eine kundenspezifische Schlauchanschlusshülse für die einfache und ausreißfeste Aufnahme für den Schutzschlauch.

Eine Verschlusskappe verschliesst die Kabeleinführung mit einer Dichtigkeit von IP 68, solange diese unbelegt bleibt.

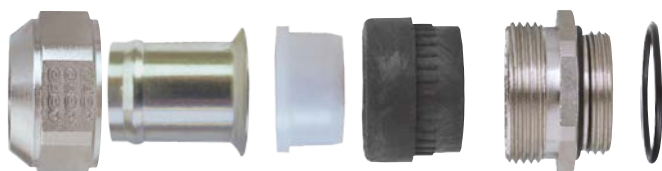

### The situation

Safety arrangements in the Gotthard tunnel are extensive and provide for permanent monitoring of trains as they pass through. At relatively short intervals, so-called axle counters check the completeness of the train. The equipment is exposed to rough tunnel conditions, including stone impacts.

### The requirements

The power cables should be protected from stone ballast by an impact-resistant conduit. The connection between cable gland and conduit should be as simple as possible.



Achszähler /  
Axle counter

### The AGRO solution

The solution is based on a standard Progress® cable gland. It is supplemented by a customised conduit connection sleeve for a simple and pullout-resistant connection of the protective conduit.

When not in use, a cap seals the cable entry to IP 68 requirements.





Das Arbeiten und Leben mit Strom birgt Risiken. Normen und staatliche Richtlinien wollen diese Risiken minimieren und Installateuren, Monteuren und zu guter Letzt auch dem Endnutzer mehr Sicherheit bieten.

**Geprüfte und zertifizierte Produkte** geben dem Installateur Sicherheit bei der Montage und die Gewissheit, dass das Produkt seine Funktion über viele Jahre erfüllen wird.

Das AGRO Labor erfüllt die relevanten Anforderung nach IEC EE OD-2048 als CTF (Customer Testing Facility) Stufe 3 im CB-Verfahren von IEC EE. Dies ermöglicht die eigenständige Durchführung von Normprüfungen und Ausstellung von international anerkannten Prüfberichten. Unser Labor entspricht den anwendbaren Anforderungen aus der ISO/IEC 17025:2017 (Allgemeine Anforderungen an die Kompetenz von Prüf- und Kalibrierlaboratorien).

Hierdurch verfügt die AGRO AG über das nötige normative Wissen (IEC EN 60079-0,-1,-7,-31 - ATEX-IECEX / IEC 62153-4-3, IEC EN 60512-5-2 / 62444 / 60670-1, -21, -22 / 60529 / EN 50085-1, -2-1 sowie UL514B und NEMA 250), um Produkte schnell und rechtssicher zu prüfen.

Die Zulassungsstellen garantieren die Zertifizierungen von Produkten nach Prüfberichten aus dem auditierten AGRO Prüflabor. Unser Prüflabor wird deshalb mindestens einmal jährlich, angemeldet sowie unangemeldet, von den jeweiligen Zulassungsstellen überprüft/auditert.

Working and living with electricity inevitably involves risks. Standards and government directives have the goal of minimising these risks and offering additional safety to electricians, installers and, of course, end users.

**Products that have been tested and certified** help ensure the technician's safety during installation. This testing also provides confidence that the product will perform its function for many years.

The AGRO laboratory fulfils the relevant requirements of IEC EE OD-2048 as a CTF (Customer Testing Facility) Level 3 in the IEC EE CB scheme. This permits the independent performance of standard tests and the issuance of internationally recognised test reports. Our laboratory complies with the applicable requirements of ISO/IEC 17025:2017. (General requirements for the competence of testing and calibration laboratories.)

As a result, AGRO AG has the necessary knowledge of applicable standards (IEC EN 60079-0,-1,-7,-31 - ATEX-IECEX / IEC 62153-4-3, IEC EN 60512-5-2 / 62444 / 60670-1, -21, -22 / 60529 / EN 50085-1, -2-1, UL514B and NEMA 250) to test products quickly and in compliance with legal requirements.

The accreditation bodies warrant the certification of products based on test reports by the audited AGRO testing laboratory. Our test laboratory is therefore checked/audited at least once a year by the responsible accreditation bodies – in some cases unannounced.

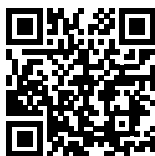

Video Prüflabor



Video Test Laboratory



Kopplungswiderstand / Schirmdämpfung  
Transfer impedance / Shield effectiveness

Alles in allem kommen die Zulassungsstellen zu folgendem Schluss:

„Die Produkte von AGRO halten, was das Unternehmen verspricht“.

Overall, the accreditation bodies come to the following conclusion:

„AGRO products perform just as the company says they will“.

### Im Mittelpunkt der Prüfung

Das erfolgreiche Bestehen der Überprüfung durch die Zulassungsstellen gibt dem Konsumenten die Gewähr, dass der Hersteller eines Produktes über das notwendige normative Wissen verfügt und dass die Prüfeinrichtungen für die Durchführung von Prüfungen nach offiziellen Standards geeignet sind. Überprüft wurden unter anderem die IP-Druckprüfanlage (Schutzart IPX8 bis 10 MPa (100 bar)), die Spritz- und Strahlwasseranlage (IPX3 bis IPX6 und IPX9K) und die Zugprüfmaschinen bis 2.5 kN (250 kg) für das Prüfen von Kabelverschraubungen, Steckdeckeln, Lampendübeln und anderen Komponenten. Ebenso der Klimaschrank für das Durchführen von Wärmealterungen, die Einrichtung für die Schlagprüfungen, mit der die Widerstandskategorie von Kabelverschraubungen ermittelt wird, und das Testgerät, mit dem die Glühdrahtfestigkeit an Bauteilen nach IEC (650°C / 850°C) geprüft wird.



Oil-Spray Test

### At the heart of the testing

Passing the testing of the accreditation bodies gives the consumer the assurance that the manufacturer of a product has the necessary knowledge of applicable standards and that the test equipment is suitable for carrying out tests according to official standards. The tests included the IP compression testing system (Protection Class IP X8 up to 10 MPa (100 bar)), the spray and jet water system (IPX3 to IPX6 and IPX9K) and the tensile testing machines up to 2.5 kN (250 kg) for testing cable glands, push-on covers, lamp boxes and other components. The same applies to the climatic exposure test cabinet for carrying out heat ageing, the device for impact tests to determine the resistance category of cable glands, and the equipment for testing the glow wire strength of components in accordance with IEC (650°C / 850°C).



Pull-out Test

### Eigens konstruierte Prüfeinrichtungen

Wir verfügen ebenfalls über eigens konstruierte Prüfeinrichtungen, welche es uns erlauben, **nach der amerikanischen UL514B zu prüfen**. Dies beinhaltet den Oil-Spray-, den Flexing- und den pull-out-Test sowie die Alterungsprüfung.

Ebenfalls im CTF-Verfahren führen wir Prüfungen und Zertifizierungen für Kabelverschraubungen durch, welche für den Einsatz in Explosionsgefährdeten Bereichen (Zündschutzart „e“ und „d“) zugelassen sind.

Desweiteren haben wir unser Testlabor um Prüfungen für den E-Mobility-Markt erweitert. In unserem EMV-Testlabor messen wir den Einfluss der Kabelverschraubung auf den Kopplungswiderstand des Kabels, oder wir bestimmen die Strombelastbarkeit von Hochvoltkabel mit Kabelverschraubung.

All dies erlaubt uns bereits in der Entwicklungsphase die Normvorschriften zu überprüfen und in die weitere Entwicklung mit einfließen zu lassen.

Darüber hinaus sind wir in den wichtigsten nationalen und internationalen Normengremien vertreten, damit wir aktiv die zukünftigen Normen mitgestalten können.

### Specially built testing facilities

We also have our own specially designed test facilities, which allow us to conduct oil-spray, flexing, pull-out and accelerated aging tests **in accordance with the American UL 514B standard**.

We also carry out CTF testing and certification of cable glands that are approved for use in potentially explosive atmospheres (ignition protection type “e” and “d”).

We have also expanded our test laboratory to include tests for the e-mobility market. In our EMC test laboratory, we can measure the influence of the cable gland on the cable's transfer impedance, for example, or we can determine the current carrying capacity of high-voltage cables with cable glands.

All of this enables us to check with respect to applicable standards already during the initial development phase, and to incorporate their requirements in the subsequent development work.

AGRO is represented in the most important national and international standardisation bodies, enabling us to take an active role in the development of future standards.

# Für jede Sonderlösung richtig

## The right choice for any special needs



### Das AGRO Prüflabor

Unser hauseigenes Prüflabor ist nach CTF-Verfahren durch die Zulassungsstellen zertifiziert und garantiert die Qualität unserer Produkte. Es kann Tests durchführen, deren Resultate durch offizielle Zertifizierungsstellen wie etwa der Eurofins, dem VDE oder den UL als Basis für die Ausstellung eines Zertifikates anerkannt werden.

### The AGRO testing laboratory

Our in-house testing laboratory is certified according to CTF program by the accreditation bodies, and ensures the quality of our products. It can carry out tests, the results of which are recognised by official certification bodies such as Eurofins, VDE or UL as the basis for an official certification.



Staubprüfung / Dust test



Schlagprüfung / Impact test



Oil Spray Test / Oil Spray Test

### Wir testen Ihre individualisierten Komponenten

Wenn ein Sonderteil normative Vorgaben erfüllen muss, so ist unser Prüflabor in der Lage, deren Einhaltung zu überprüfen - mit Ihrem individuellen Produkt und den effektiv eingesetzten Kabeln. Eine grösstmögliche Gewährleistung der Funktionssicherheit unter spezifischen Bedingungen kann so geboten werden. Unser Prüflabor ist mit zeitgemäßem Equipment ausgerüstet und kann folgende Tests durchführen:

- Wasserdruckfestigkeit
- Spritz- und Strahlwasserbeständigkeit
- Zugkraft
- Glühdrahtfestigkeit
- Querdruck
- Wärmealterung
- Wechselbiegefestigkeit
- Staubprüfung
- Klimatest
- Oil Spray Test
- Schlagprüfung
- Strombelastbarkeit
- Kopplungswiderstand Kabelschirm (EMV)
- etc.

### We can test your customised components

If a special part is required to comply with official standards or requirements, our testing laboratory can check its compliance - with your specific product and the cables that are to be used in practice. This ensures the greatest possible assurance of functional reliability under specific conditions. Our testing laboratory is well equipped with up-to-date instruments and can carry out the following tests:

- Water pressure resistance
- Resistance to water splashes and water jets
- Tensile strength
- Glow wire resistance
- Lateral pressure resistance
- Thermal ageing
- Flexural strength
- Dust test
- Climatic test
- Oil spray test
- Impact resistance
- current carrying capacity
- transfer impedance of cable shield (EMC)
- etc.



### Die Ausgangslage

Für den Wagenübergang bei Zügen wurde eine Sonderlösung ausgearbeitet, bei der grosses Gewicht auf Vibrationsicherheit und schonende Kabelklemmung gelegt wurde. Der Dichteinsatz der Kabelverschraubung musste gemäss Anforderungen der EN 45545 ausgeführt sein.

### The situation

A special solution needed to be worked out for the inter-carriage transitions of a particular type of trains, in which great emphasis was placed on vibration resistance and especially protective cable clamping. The sealing insert of the cable gland required to be designed in accordance with EN 45545.



Dichtheitsprüfung / Sealing test



Biegetest / Flexing Test

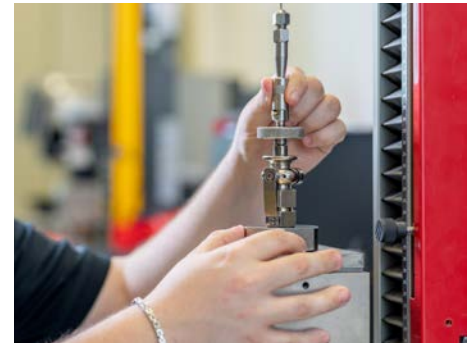

Zugprüfung / Tensile test

### Prüfanordnung

Die Kabelverschraubung mit dem F-Dichteinsatz wurde als erstes mit dem Originalkabel einer Dichtheitsprüfung unterzogen, anschliessend wurde ebenfalls mit dem einzusetzenden Jumperkabel ein Flexingtest mit 500 Zyklen durchgeführt. Nach dieser Belastung wurde eine weitere Dichtheitsprüfung durchgeführt, um zu eruieren, ob - und falls ja - wie stark die Dichtleistung abgenommen hat.

Zu guter Letzt wurde mit der bereits belasteten Kabelverschraubung die maximale Auszugskraft ermittelt.

Nachdem die Kombination Kabelverschraubung-Kabel die Tests erfolgreich bestanden hat, kann der Kunde mit Zuversicht davon ausgehen, dass das ausgearbeitete Sonderenteil im realen Einsatz seine Aufgabe langfristig lösen wird.

### Test arrangement

A cable gland with an F-type sealing insert was first subjected to a sealing test, using the original cable. Then a 500-cycle flexing test was carried out using the proposed jumper cable. After this loading, a further sealing test was carried out to determine whether - and if so, by how much - the sealing performance had decreased.

Finally, the maximum pull-out force was determined using the already stressed cable gland.

After the cable gland / cable combination had successfully passed the tests, the customer could have confidence that the special part as developed will provide good, reliable long-term performance.

# Sonderlösung für very heavy duty

## Special solution for "very heavy duty" application

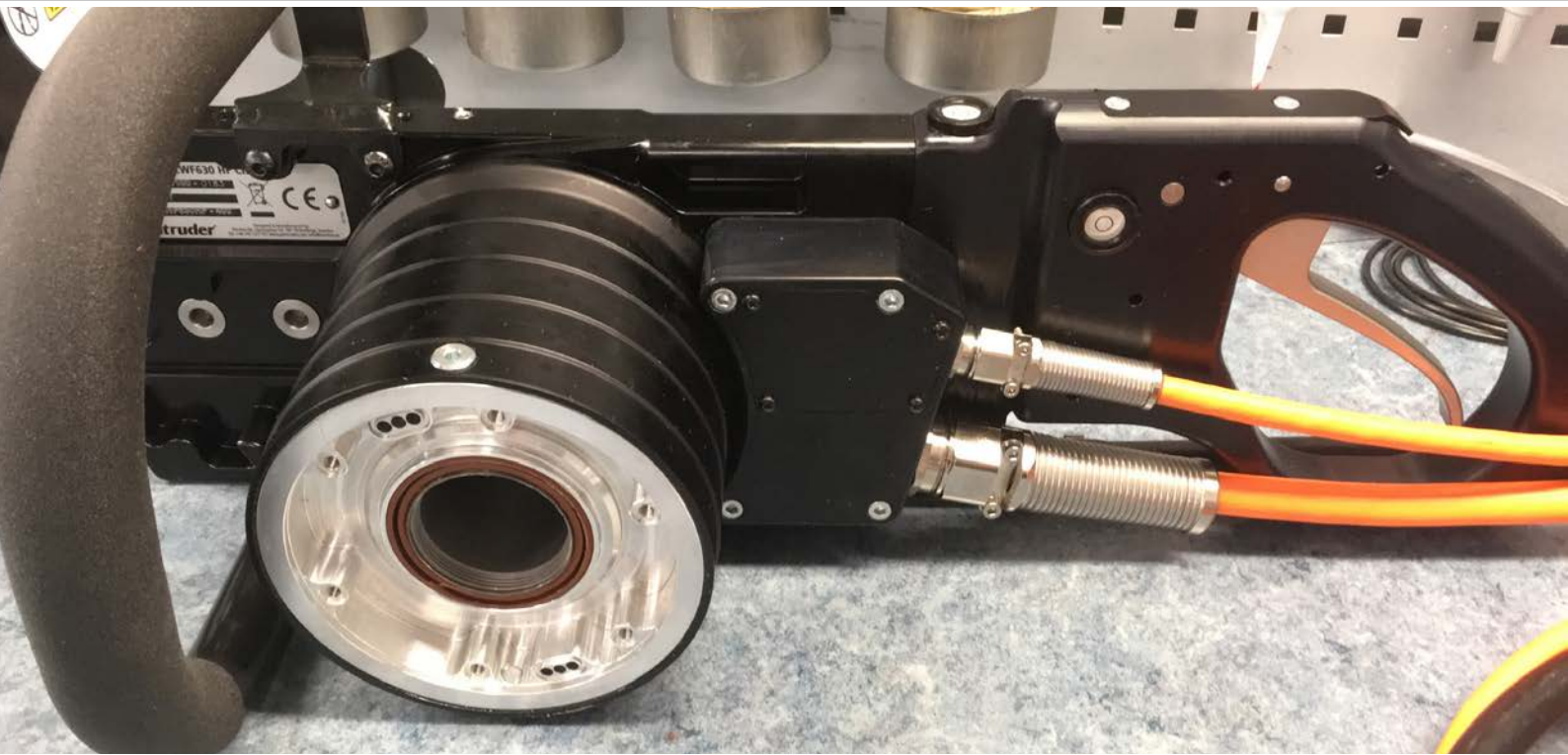

### Die Ausgangslage

Betonbearbeitungsmaschinen müssen viel aushalten können. Sowohl Wasser als auch Steinschlag darf ihnen nichts anhaben können. Kabeleintrittsstellen sind besonders gefährdet.

### Die Anforderungen

Die Kabel sollten durch einen Knickschutz vor Überbelastung geschützt und im gleichen Zug soll verhindert werden, dass Kabel ausreißen können. Gleichzeitig sollte ein EMV-Abgriff bei der Eintrittsstelle erfolgen.



Progress® mit Knickschutzfeder und Klemmbacken /  
Progress® with anti-kink spring and clamps

### Die Lösung von AGRO

Die Standard-EMV-Kabelverschraubung mit Knickschutzfeder aus gewendelttem Edelstahl bildet die Basis der Lösung. Sie fängt selbst hohe dynamische Biegebelastungen sicher am Kabeleintritt ab und sorgt dafür, dass das Kabel vor Quetschen und Abknicken geschützt ist. Mit den zusätzlich integrierten Klemmbacken wird eine sehr hohe Zugentlastung erreicht, die verhindert, dass das Kabel ausgerissen wird und gewährleistet, dass die EMV-Schirmkontaktierung trotz dynamischer Belastung sicher bleibt.

### The situation

Construction equipment for concrete must be able to withstand a great deal. It should not be damaged by water or stone impacts. Cable entry points are particularly vulnerable.

### The requirements

Cables required to be protected against kinking while also being prevented from pulling out of the enclosure. An EMC grip was required at the entry point.



Betonsägemaschine /  
Concrete saw

### The AGRO solution

The solution is based on the standard EMC cable gland with anti-kink protection from a spiral stainless-steel spring. It safely absorbs even high dynamic bending loads at the cable entry point, and protects the cable against crushing and buckling. With the additionally integrated clamping jaws, a very high degree of strain relief is achieved, which prevents the cable from being pulled out and ensures that the EMC shield contact remains secure despite the dynamic loading.

### Montageanleitung für Kabelverschraubungen Progress® Assembly instructions for Progress® cable glands

Das Unterteil der Kabelverschraubung in das entsprechende Gewinde einschrauben.

Oder:

Das Unterteil der Kabelverschraubung in die vorhandene Eintrittsöffnung im Gehäuse einführen und mittels Gegenmutter befestigen.

Wenn bei zweiteiligen Dichteinsätzen der Kabeldurchmesser das obere Ende des Klemmbereiches der Kabelverschraubung erreicht, muss der innere Teil des Dichteinsatzes entfernt werden.

Kabel, Dichteinsatz und Druckmutter in das Unterteil einführen, Druckmutter von Hand leicht verschrauben.

Druckmutter mit passendem Gabelschlüssel anziehen bis der Dichteinsatz zwischen Druckmutter und Kabel einen kleinen Wulst bildet.

Bitte benutzen Sie die Tabelle Montage-Drehmoment auf unserer Website [www.agro.ch](http://www.agro.ch).

Montage nur durch in der Elektrotechnik ausgebildete Installateure! Liegen keine entsprechenden Fachkenntnisse vor, so kann es zu einer unsachgemässen Montage kommen, welche die Sicherheit des Produktnutzers gefährdet.

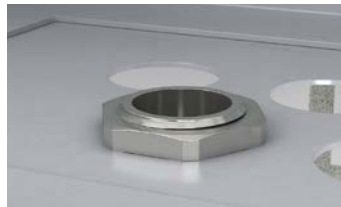

Screw the lower part of the cable gland into the corresponding thread.

Or:

Put the lower part of the cable gland into an existing opening in the enclosure and fix it by means of a lock nut.

Remove the inner part of the two-piece sealing insert if the cable diameter is at the upper end of the clamping range of the cable gland.

Insert the cable, sealing insert and compression nut into the lower part of the cable gland and manually tighten the compression nut.

Tighten the compression nut by means of a spanner until the sealing insert bulges slightly between the compression nut and the cable.

Please refer to the instruction sheet with details of installation torques on our website, [www.agro.ch](http://www.agro.ch).

Installation only by competent technicians with suitable training in the field of electro-technology! If the installer does not have the required specialist knowledge, this can result in improper installation, jeopardising the safety of the product user.

### Progress® EMV easyCONNECT Messing

Kontaktfeder aus dem Unterteil der Kabelverschraubung entfernen.



Das Unterteil der Kabelverschraubung in das entsprechende Gewinde einschrauben oder in die vorhandene Eintrittsöffnung im Gehäuse einführen und mittels Gegenmutter befestigen.



Kabel abisolieren.



Kontaktfeder auf den Kabelschirm aufsetzen.



Wenn bei zweiteiligen Dichteinsätzen der Kabeldurchmesser das obere Ende des Klemmbereiches der Kabelverschraubung erreicht, muss der innere Teil des Dichteinsatzes entfernt werden.



Kabel, Kontaktfeder, Dichteinsatz und Druckmutter in das Unterteil einführen, Druckmutter von Hand leicht verschrauben.



Druckmutter mit passendem Gabelschlüssel anziehen bis der Dichteinsatz zwischen Druckmutter und Kabel einen kleinen Wulst bildet.

Bitte benutzen Sie die Tabelle Montage-Drehmoment auf unserer Website [www.agro.ch](http://www.agro.ch).



Montage nur durch in der Elektrotechnik ausgebildete Installateure! Liegen keine entsprechenden Fachkenntnisse vor, so kann es zu einer unsachgemäßen Montage kommen, welche die Sicherheit des Produktnutzers gefährdet.



### Progress® EMC easyCONNECT brass

Remove the contact spring from the lower part of the cable gland.

Screw the lower part of the cable gland into the corresponding thread or put it into an existing opening in the enclosure and fix it by means of a lock nut.

Strip the cable.

Clip the contact spring onto the cable shield.

Remove the inner part of the two-piece sealing insert if the cable diameter is at the upper end of the clamping range of the cable gland.

Insert the cable, contact spring, sealing insert and compression nut into the lower part of the cable gland and manually tighten the compression nut.

Tighten the compression nut by means of a spanner until the sealing insert bulges slightly between the compression nut and the cable.

Please refer to the instruction sheet with details of installation torques on our website, [www.agro.ch](http://www.agro.ch).

Installation only by competent technicians with suitable training in the field of electro-technology! If the installer does not have the required specialist knowledge, this can result in improper installation, jeopardising the safety of the product user.

## Progress® EMV powerCONNECT Messing

## Progress® EMC powerCONNECT brass

Kabel vorbereiten, empfohlene Schirmlänge gemäss Tabelle.

M16	13 mm +
M20	14 mm +
M25	15 mm +
M32	17 mm +
M40	18 mm +
M50/63	20 mm +
M75/80/85	22 mm +

Prepare cable, consult table for recommended shield length.

Bauteile auf Kabel aufreihen.  
ACHTUNG - Einbau Presshülse.



Line up components on the cable.  
ATTENTION - Orientation of compression ring.

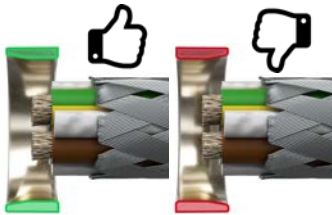

Kabel in Unterteil einführen, Geflecht leicht auffächern und über Konus stülpen.



Insert the cable through the cable gland's lower part, loosen the shield braiding to spread it lightly apart, and insert the shield braiding into the recess of the cable gland's lower part, onto its tapered surface.

Presshülse über Geflecht in Konus schieben.



Push the compression ring into the recess of the cable gland's lower part, clamping the shield braiding onto the tapered surface.

Zwischenstück (mit Dichteinsatz als Zentrierhilfe) aufschrauben und bis auf Block festdrehen.



Screw on the intermediate piece (with the sealing insert acting as a centring aid) and tighten it fully.



Druckmutter auf Zwischenstück schieben und mit Werkzeug anziehen bis der Dichteinsatz zwischen Druckmutter und Kabel einen kleinen Wulst bildet.

Bitte benutzen Sie die Tabelle Montage-Drehmoment auf unserer Website [www.agro.ch](http://www.agro.ch).



Place the compression nut onto the intermediate piece and tighten with a spanner until the sealing insert bulges slightly between the compression nut and the cable.

Please refer to the instruction sheet with details of installation torques on our website, [www.agro.ch](http://www.agro.ch).

Montage nur durch in der Elektrotechnik ausgebildete Installateure! Liegen keine entsprechenden Fachkenntnisse vor, so kann es zu einer unsachgemässen Montage kommen, welche die Sicherheit des Produktnutzers gefährdet.



Installation only by competent technicians with suitable training in the field of electro-technology! If the installer does not have the required specialist knowledge, this can result in improper installation, jeopardising the safety of the product user.

### Progress® EMV RAPID

**1** Komplette Kabelverschraubung (5 Teile) in das vorgesehene Gehäuse einschrauben, ohne die Druckmutter fester anzuziehen.

**2** Kabelaussenmantel partiell abisolieren oder auf gewünschte Länge zuschneiden.

Hinweis: Zum Schutz des Kabelschirms, kann ein Kupfer-Tape auf den Schirm montiert werden.

**3** Kabel in die Kabelverschraubung einführen, bis der Schirm in der Kontaktscheibe (5) einrastet oder der Kabelmantel an der Scheibe ansteht.

**4** Druckmutter (1) mit dem Unterteil (4) verschrauben bis der Dichteinsatz zwischen Druckmutter und Kabel einen kleinen Wulst bildet.

Bitte benutzen Sie die Tabelle Montage-Drehmoment auf unserer Website [www.agro.ch](http://www.agro.ch).

Die Progress® EMV Rapid kann durch Ausstossen der Kontaktscheibe (5) auch ohne Weiterführen des Schirms montiert werden. Weitere Informationen dazu in der Montageanleitung der PROGRESS EMV oder dem Montagevideo auf unserer Webseite [www.agro.ch](http://www.agro.ch).

Montage nur durch in der Elektrotechnik ausgebildete Installateure! Liegen keine entsprechenden Fachkenntnisse vor, so kann es zu einer unsachgemässen Montage kommen, welche die Sicherheit des Produktnutzers gefährdet.

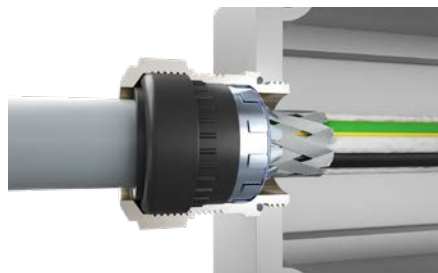
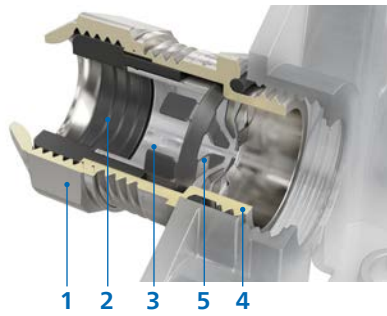

**1** Screw in the complete cable gland (5 parts) into the intended housing without further tightening the compression nut.

**2** Partially dismantle the outer cable sleeve or trim to the desired length.

Note: To protect the cable shield, a copper tape may be wrapped around the shield.

**3** Feed cable into the cable gland until the shielding engages with the contact disc (5) or the cable sheath comes in contact with the disc.

**4** Tighten compression nut (1) onto the cable gland's lower part (4) until the sealing insert bulges slightly between the compression nut and the cable.

Please refer to the instruction sheet with details of installation torques on our website, [www.agro.ch](http://www.agro.ch).

The Progress® EMC Rapid can also be mounted by pushing out the contact disc (5) if the cable shield can be cut at this location. Further information can be found in the PROGRESS® EMC installation instructions or by viewing the installation video on our website, [www.agro.ch](http://www.agro.ch).

Installation only by competent technicians with suitable training in the field of electro-technology! If the installer does not have the required specialist knowledge, this can result in improper installation, jeopardising the safety of the product user.



## Progress® EMV

- 1 Unterteil (4) der Kabelverschraubung in das vorgesehene Gehäuse einschrauben.
- 2 Druckmutter (1), Dichteinsatz (2) und Kontakthülse (3) über das Kabel ziehen.
- 3 Aussenmantel des Kabels auf die gewünschte Länge zurückschneiden.
- 4 Schirmumflechtung oder Schirmfolie ungefähr auf Kontakthülslänge X zuschneiden.
- 5 Kontakthülse, Dichteinsatz und Druckmutter bis Mantelende vorschieben.

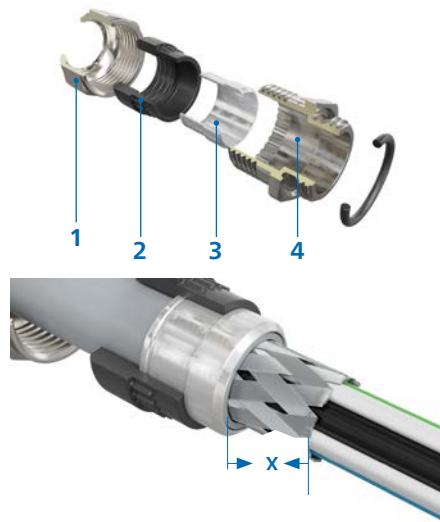

- 6 Schirmgeflecht (6) oder Schirmfolie über Kontakthülse legen und überstehendes Schirmmaterial abschneiden.

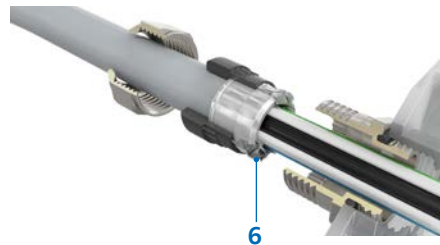

- 7 Kabel durch das bereits montierte Unterteil der Kabelverschraubung führen.

- 8 Dichteinsatz und Kontakthülse bündig in das Unterteil stecken.

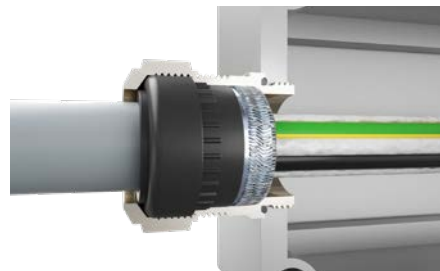

- 9 Druckmutter mit dem Unterteil verschrauben, bis der Dichteinsatz zwischen Druckmutter und Kabel einen kleinen Wulst bildet.

Bitte benutzen Sie die Tabelle Montage-Drehmoment auf unserer Website [www.agro.ch](http://www.agro.ch).



Montage nur durch in der Elektrotechnik ausgebildete Installateure! Liegen keine entsprechenden Fachkenntnisse vor, so kann es zu einer unsachgemässen Montage kommen, welche die Sicherheit des Produktnutzers gefährdet.



- 1 Screw the lower part (4) of the cable gland into the housing.
- 2 Push compression nut (1), sealing insert (2) and contact sleeve (3) over the cable.
- 3 Trim outer sheath of the cable to the desired length.
- 4 Trim shield braiding or shield foil to the the approximate length of the contact sleeve, X.
- 5 Push contact sleeve, sealing insert and compression nut to the end of the sheath.

- 6 Turn back the shield braiding (6) or shield foil over the contact sleeve and cut off the protruding shield material.

- 7 Feed cable through the already mounted lower part of the cable gland.

- 8 Insert sealing insert and contact sleeve fully and cleanly into the lower part.

- 9 Tighten compression nut to the lower part until the sealing insert bulges slightly between the compression nut and the cable. Please refer to the instruction sheet with details of installation torques on our website, [www.agro.ch](http://www.agro.ch).

Installation only by competent technicians with suitable training in the field of electro-technology! If the installer does not have the required specialist knowledge, this can result in improper installation, jeopardising the safety of the product user.

### Progress® EMV Serie 85

1 Den Kabelmantel und Kabelschirm mit einer Schere sauber auf die gewünschte Länge zurückschneiden, wenn der Kabelschirm nicht weiter geführt werden muss.

**Um den Kabelschirm optimal zu schützen, ist es erforderlich, das der Lieferung beiliegende Kupfer-EMV-Tape (Kupferklebeband 25 mm, Scotch 3M Typ 1181) zu montieren.**

2 Das Unterteil (Pos. 5) der Kabelverschraubung in das vorgesehene Gehäuse einschrauben, Druckmutter (Pos. 1), Dichteinsatz (Pos. 2), Zwischenstück (Pos. 4) und Spannzange (Pos. 3) über das Kabel aufschieben. Kabel mit der Spannzange in das Unterteil einführen und positionieren.

3 Zwischenstück mit dem Unterteil verschrauben, bis das Kabel fühlbar geklemmt wird, anschließend gemäss unten stehender Tabelle festziehen.

4 Druckmutter mit dem Zwischenstück (Zwischenstück mit Schlüssel kontern) verschrauben.

Bitte benutzen Sie die Tabelle Montage-Drehmoment auf unserer Website [www.agro.ch](http://www.agro.ch).

Montage nur durch in der Elektrotechnik ausgebildete Installateure! Liegen keine entsprechenden Fachkenntnisse vor, so kann es zu einer unsachgemässen Montage kommen, welche die Sicherheit des Produktnutzers gefährdet.

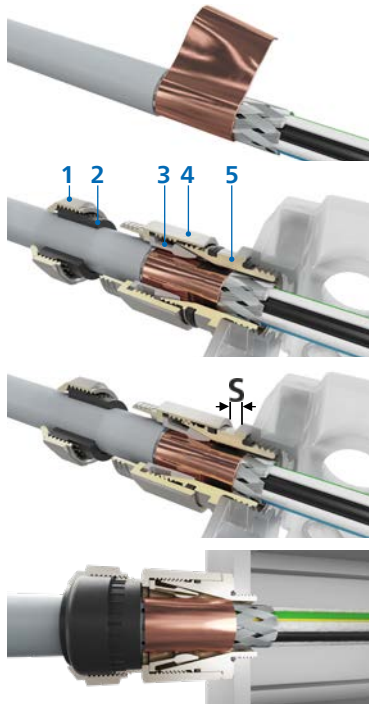

### Progress® EMC Series 85

1 Trim the outer cable sheath and cable shield neatly to the desired length using a cutter if the cable shield need not be continued.

**To provide the best possible protection for the cable shield, it is necessary to use the supplied copper EMC tape (copper adhesive tape 25 mm wide, Scotch 3M type 1181).**

2 Screw the lower part (item 5) of the cable gland into the housing. Push the compression nut (item 1), sealing insert (item 2), intermediate piece (item 4) and collet-grip piece (item 3) over the cable. Insert the cable with the collet-grip piece on it into the cable gland's lower part, and position it.

3 Screw the intermediate piece onto the cable gland's lower part until the cable becomes tangibly clamped, then tighten according to the table below.

4 Screw the compression nut onto the intermediate piece (hold the intermediate piece using a spanner)

Please refer to the instruction sheet with details of installation torques on our website, [www.agro.ch](http://www.agro.ch).

Installation only by competent technicians with suitable training in the field of electrotechnology! If the installer does not have the required specialist knowledge, this can result in improper installation, jeopardising the safety of the product user.

**Das Kupfer-Tape muss zwingend gemäss Illustration montiert werden! Klebeschutzfolie vorgängig entfernen.**

The copper tape must be applied as shown in the illustration! Remove protection film first.

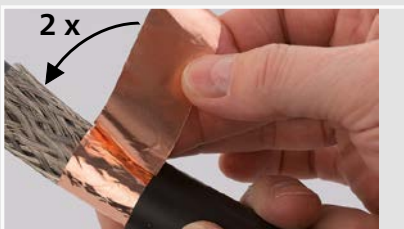

Tape: Scotch 3M Typ 1181  
Tape: Scotch 3M Type 1181



#### Hilfstabelle zur optimalen Schirmkontaktierung

Die Angaben dienen als Arbeitshilfe und ermöglichen eine fachgerechte Montage der Kabelverschraubung Progress EMV Serie 85. Die Richtwerte sind unverbindlich.

#### Information Table for Optimum Shield Contact

The information is provided as a work aid and facilitates professional installation of the Progress EMC Series 85 cable gland. The reference values are provided for general guidance only and are non-binding.

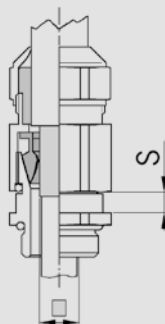

Art-Nr. Art. No.	Ø Schirm Ø Shield	S mm
1000.17.85.045	3.0 - 4.0 4.0 - 4.5	0 1.0
1000.17.85.080	4.5 - 6.0 6.0 - 8.0	0 1.5
1000.17.85.100	7.5 - 10.0 7.5 - 10.0	0 0
1000.20.85.120	10.0 - 12.0 10.0 - 12.0	1.5 0
1000.20.85.140	12.0 - 14.0 12.0 - 14.0	1.5 0
1000.25.85.160	13.0 - 16.0 13.0 - 16.0	2.0 0
1000.25.85.190	14.0 - 16.5 16.5 - 19.0	0 2.0
1000.32.85.220	14.0 - 18.0 18.0 - 22.0	0 3.0
1000.32.85.250	21.0 - 23.0 23.0 - 25.0	0 2.0
1000.40.85.300	21.0 - 25.5 25.5 - 30.0	0 3.0
1000.50.85.380	29.0 - 33.5 33.5 - 38.0	0 3.0
1000.63.85.380	29.0 - 33.5 33.5 - 38.0	0 3.0
1000.63.85.440	35.0 - 39.5 39.5 - 44.0	0.5 3.0

	<b>G</b> [mm]	<b>P</b> [mm]	<b>K</b> [mm]	<b>Df</b> [mm]	<b>D<sup>+0.2</sup><sub>0</sub></b> [mm]
<b>Metrisches Gewinde   Metric thread</b>					
M6x1.0 <sup>1)</sup>	6.0	1.0	5.00	6.8	6.0
M6x0.75 <sup>2)</sup>	6.0	0.75	5.25	6.8	6.0
M8x1.25 <sup>1)</sup>	8.0	1.25	6.75	8.8	8.0
M8x1.0 <sup>2)</sup>	8.0	1.0	7.00	8.8	8.0
M10x1.5 <sup>1)</sup>	10.0	1.5	8.50	10.8	10.0
M10x1.0 <sup>2)</sup>	10.0	1.0	9.00	10.8	10.0
M12x1.5	12.0	1.5	10.50	12.8	12.0
M16x1.5	16.0	1.5	14.50	16.8	16.0
M20x1.5	20.0	1.5	18.50	21.0	20.0
M25x1.5	25.0	1.5	23.50	26.0	25.0
M32x1.5	32.0	1.5	30.50	33.0	32.0
M40x1.5	40.0	1.5	38.50	41.0	40.2
M50x1.5	50.0	1.5	48.50	51.0	50.2
M63x1.5	63.0	1.5	61.50	64.0	63.2
M75x1.5	75.0	1.5	73.50	76.0	75.2
M80x1.5	80.0	1.5	78.50	81.0	80.2
M85x2.0	85.0	2.0	83.00	86.0	85.2
M95x2.0	95.0	2.0	93.00	96.0	95.2
M100x3.0	100.0	3.0	97.00	101.0	100.2
M105x3.0	105.0	3.0	102.00	106.0	105.2
M115x3.0	115.0	3.0	112.00	116.0	115.2
<b>Pg Gewinde   Pg thread</b>					
Pg 7	12.5	1.27	11.40		12.6
Pg 9	15.2	1.41	14.00		15.3
Pg 11	18.6	1.41	17.25		18.7
Pg 13	20.4	1.41	19.00		20.5
Pg 16	22.5	1.41	21.25		22.6
Pg 21	28.3	1.59	26.75		28.4
Pg 29	37.0	1.59	35.50		37.2
Pg 36	47.0	1.59	45.50		47.2
Pg 42	54.0	1.59	52.50		54.2
Pg 48	59.3	1.59	57.80		59.5
<b>Gasrohr-Gewinde   Gas-pipe thread</b>					
G <sup>1</sup> / <sub>4</sub> "	13.15	1.33	11.60		13.3
G <sup>3</sup> / <sub>8</sub> "	16.66	1.33	15.00		16.8
G <sup>1</sup> / <sub>2</sub> "	20.95	1.81	19.00		21.0
G <sup>5</sup> / <sub>8</sub> "	22.91	1.81	21.00		23.0
G <sup>3</sup> / <sub>4</sub> "	26.44	1.81	24.60		26.5
G1"	33.25	2.30	30.50		33.5
G1 <sup>1</sup> / <sub>4</sub> "	41.91	2.30	39.50		42.2
G1 <sup>1</sup> / <sub>2</sub> "	47.80	2.30	45.00		48.0
G2"	59.61	2.30	57.00		60.0
G2 <sup>1</sup> / <sub>2</sub> "	75.18	2.30	72.50		75.5
G3"	87.88	2.30	84.50		88.0
G4"	113.03	2.30	110.50		113.5
G5"	138.43	2.30	136.00		139.0
<b>NPT Gewinde   NPT thread</b>					
NPT <sup>1</sup> / <sub>8</sub> "	10.29	0.94	8.43		-
NPT <sup>1</sup> / <sub>7</sub> "	13.72	1.41	11.13		-
NPT <sup>3</sup> / <sub>8</sub> "	17.14	1.41	14.27		-
NPT <sup>1</sup> / <sub>2</sub> "	21.34	1.81	17.86		-
NPT <sup>3</sup> / <sub>4</sub> "	26.67	1.81	23.28		-
NPT 1"	33.40	2.20	28.98		-
NPT 1 <sup>1</sup> / <sub>4</sub> "	42.16	2.20	37.69		-
NPT 1 <sup>1</sup> / <sub>2</sub> "	48.26	2.20	43.66		-
NPT 2"	60.32	2.20	55.58		-

1) Metrisches Regelgewinde  
2) Metrisches Gewinde nach EN60423

1) Metric ISO thread  
2) Metric thread according to EN 60423

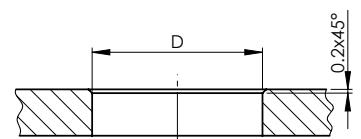
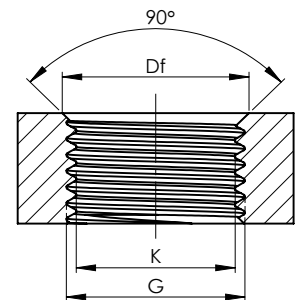
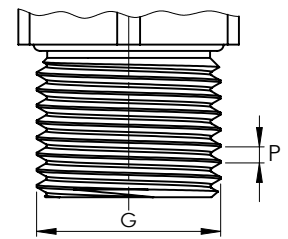
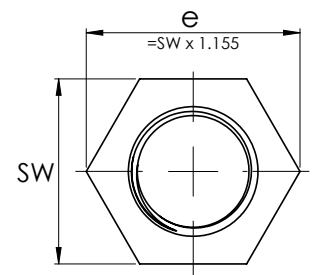







**1. Ziffer:**

Schutzgrad für Berührungs- und Fremdkörperchutz

**1st figure:**

Degree of protection against access to hazardous parts and the ingress of solid foreign objects

Definitionen Definitions	
<b>IP 0x</b>	<b>Kein Schutz</b> No protection
<b>IP 1x</b> 	Schutz gegen Eindringen von festen Fremdkörpern grösser als 50 mm (unbeabsichtigtes Berühren mit der Hand) Protection against penetration by solid foreign objects larger than 50 mm (accidental touching by hand)
<b>IP 2x</b> 	Schutz gegen Eindringen von festen Fremdkörpern grösser als 12.5 mm (unbeabsichtigtes Berühren mit den Fingern, z.B. Prüffinger 12 mm Durchmesser und Länge 80 mm) Protection against penetration by solid foreign objects larger than 12.5 mm (accidental contact with fingers, e.g. test finger 12 mm diameter, length 80 mm).
<b>IP 3x</b> 	Schutz gegen Eindringen von festen Fremdkörpern grösser als 2.5 mm (unbeabsichtigtes Berühren mit Werkzeugen, Drähten usw., dicker als 2.5 mm) Protection against penetration by solid foreign objects larger than 2.5 mm (accidental touching with tools, wires etc. larger than 2.5 mm)
<b>IP 4x</b> 	Schutz gegen Eindringen von festen Fremdkörpern grösser als 1 mm (Berühren mit Werkzeugen, Drähten usw., dicker als 1 mm) Protection against penetration by solid foreign objects larger than 1 mm (touching with tools, wires etc. larger than 1 mm)
<b>IP 5x</b> 	Vollständiger Schutz gegen Berühren, Schutz gegen schädliche Staubablagerung – Eindringen von Staub wird nicht vollkommen verhindert Complete protection from being touched. Protection from harmful dust deposits - dust penetration is not completely prevented
<b>IP 6x</b> 	Vollständiger Schutz gegen Berühren, Schutz gegen Eindringen von Staub Complete protection from being touched. Protection against penetration by dust.









Genauere Erläuterungen finden sich in den aktuellen Normen.  
More detailed explanations can be found in the current standards.

**2. Ziffer:**

Schutzgrad für Wasserschutz

**2nd figure:**

Liquid ingress protection

Definitionen Definitions	
<b>IP x0</b>	<b>Kein Schutz</b> No protection
<b>IP x1</b> 	Senkrecht fallende Tropfen dürfen keine schädigende Wirkung haben Dripping water (vertically falling drops) shall have no harmful effect
<b>IP x2</b> 	Senkrecht fallende Tropfen dürfen keine schädigende Wirkung haben, wenn das Gehäuse um einen Winkel von bis zu 15° beiderseits der Senkrechten geneigt ist Vertically dripping water shall have no harmful effect when the enclosure is tilted at an angle up to 15° from its upright position
<b>IP x3</b> 	Sprühwasser, das in einem Winkel bis zu 60° beiderseits der Senkrechten gesprüht wird, darf keine schädliche Wirkung haben Water spray sprayed at any angle of up to 60° from the vertical shall have no harmful effect
<b>IP x4</b> 	Spritzwasser, das aus jeder Richtung gegen das Gehäuse spritzt, darf keine schädliche Wirkung haben Splash water splashing against the enclosure from any direction shall have no harmful effect
<b>IP x5</b> 	Strahlwasser, das aus jeder Richtung als Strahl gegen das Gehäuse gerichtet ist, darf keine schädliche Wirkung haben Water jets directed against the enclosure from any direction shall have no harmful effects
<b>IP x6</b> 	Starkes Strahlwasser, das aus jeder Richtung als starker Strahl gegen das Gehäuse spritzt, darf keine schädliche Wirkung haben Strong jets of water projected in powerful jets against the enclosure from any direction shall have no harmful effects
<b>IP x7</b> 	Wasser darf nicht in einer Menge eintreten, die schädliche Wirkungen verursacht, wenn das Gehäuse unter genormten Druck- und Zeitbedingungen zeitweilig in Wasser getaucht ist Ingress of water in harmful quantity shall not be possible when the enclosure is immersed in water under defined conditions of pressure and time
<b>IP x8</b> 	Wasser darf nicht in einer Menge eintreten, die schädliche Wirkungen verursacht, wenn das Gehäuse dauernd unter Wasser getaucht ist unter Bedingungen, die zwischen Hersteller und Anwender vereinbart werden müssen; die Bedingungen müssen jedoch schwieriger sein als für Kennziffer 7 Water must not enter in a quantity causing harmful effects when the enclosure is continuously submerged in water under conditions to be agreed between the manufacturer and the user; however, the conditions must be more demanding than for code number 7
<b>IP x9</b>	Schutz gegen Eindringen von Wasser unter Hochdruck (80-100 bar) mit einer Temperatur bis 80°C (z. B. Dampfstrahlreinigung) Protection against ingress of water under high pressure (80-100 bar) with a temperature of up to 80°C (e. g. steam jet cleaning)

# Materialübersichtstabelle – Metalle

## Materials overview – Metals

Produkt Product	Messing vernickelt Nickel-plated brass	Messing bleifrei Lead-free brass	Stahl A2 Stainless steel A2	Stahl A4 Stainless steel A4	Aluminium Aluminium	Aluminium Aluminium
<b>Materialbezeichnung</b> Material designation	CuZn39Pb3	CuZn21Si3P CW724R	X8CrNiS 18 9 DIN 1.4305/ AISI 303	X2CrNiMo 18 14 3 DIN 1.4435/AISI 316 L	AlMgSi0.5 DIN 3.3206	AlMg4,5Mn0.7 DIN 3.3547
<b>Bezeichnung</b> Designation	Kupfer/Zinklegierung Oberfläche galvanisch vernickelt Copper/zinc alloy Surface galvanically nickel-plated	Si-haltiges, bleifreies Sondermessing Oberfläche galvanisch vernickelt Si-containing, lead-free special brass Surface galvanically nickel-plated	Rostbeständiger Stahl Stainless steel	Rost- und säurebeständiger Stahl Acid-resistant stainless steel	Aluminium Aluminium	Aluminium Aluminium
<b>Korrosionsverhalten</b> <b>Chem. Beständigkeit</b> <b>Corrodibility</b> <b>Chemical resistance</b>	Gut beständig in trockener Atmosphäre, Süßwasser, Wasserdampf, Mineralölen, Kraftstoffen, Kühl-/Schmierstoffen und vielen organischen Emulsionen High resistance in dry atmosphere, freshwater, water vapour, mineral oils, motor fuels, coolants/lubricants and many other organic emulsions	Gut beständig in normaler trockener Atmosphäre, gegen Süßwasser, Mineralöle, Kraftstoffe, Kühl- und Schneidflüssigkeiten, in Meeres- und Industrieatmosphäre, gegen neutrale und alkalische Salzlösungen sowie organische Verbindungen Good resistance in a normal, dry atmosphere, against fresh water, mineral oils, fuels, cooling and cutting fluids, in marine and industrial atmospheres, against neutral and alkaline saline solutions and organic compounds	Gut beständig gegen verdünnte organische und oxidierende Säuren, Laugen, neutrale und alkalische Salzlösungen sowie organische Verbindungen High resistance against diluted organic and oxidizing acids, bases, neutral and alkaline saline solutions, as well as against organic compounds	Gute Beständigkeit gegen organische Säuren, z.B. Zitronen-, Milch-, Ameisen-, Wein- und Essigsäure, bei hoher Konzentration und Temperatur. Anorganische Säuren, z.B. Bor-Phosphor- und Salpetersäure sowie schweflige Säure, bei mässiger Konzentration und Temperatur Good resistance against organic acids such as citric, lactic, formic, tartaric and acetic acids, in high concentrations and at high temperatures. Good resistance against inorganic acids such as boric, phosphoric, nitric and sulphurous acids, at moderate concentrations and temperatures	Gut beständig in trockener Atmosphäre, Mineralölen, Kraftstoffen Good resistance in dry atmosphere, mineral oils, motor fuels	Sehr gute Korrosionsbeständigkeit in Süß-, Brack- und Meerwasser sowie in trockener Atmosphäre Very good corrosion resistance in freshwater, brackwater, seawater and dry atmosphere
<b>Bedingt bzw. nicht beständig</b> <b>Non-resistant or only partially resistant</b>	Meer-, Brackwasser, feuchte Atmosphären, Säuren, Laugen, Chloride, Ammoniak Seawater, brackwater, humid atmospheres, acids, alkaline solutions, chlorides, ammonia	Unbeständig gegen Säuren, Halogene, Chloride und chloridhaltige Lösungen in Atmosphären mit hoher Feuchte und erhöhten Temperaturen Not resistant to acids, halogens, chlorides and chloride-containing solutions in atmospheres with high humidity and elevated temperatures	Anorganische Säuren, Halogene, Chloride und chloridhaltige Lösungen oder Atmosphären Inorganic acids, halogens, chlorides and chloride-containing solutions or atmospheres	Salzsäure, Halogene, Chloride und chloridhaltige Lösungen oder Atmosphären Hydrochloric acid, halogens, chlorides and chloride-containing solutions or atmospheres	Süß-, Meer-, Brackwasser, feuchte Atmosphären, Säuren, Laugen Freshwater, seawater, brackwater, humid atmospheres, acids, alkaline solutions	Bedingt beständig gegen Säuren und Laugen Partial resistance to acids and alkaline solutions
<b>Witterungsbeständigkeit</b> <b>Resistance to weathering</b>	Sehr gute Witterungs- und Alterungsbeständigkeit Very good resistance to weathering and ageing	Sehr gute Witterungs- und Alterungsbeständigkeit Very good resistance to weathering and ageing	Sehr gute Witterungs- und Alterungsbeständigkeit Very good resistance to weathering and ageing	Sehr gute Witterungs- und Alterungsbeständigkeit Very good resistance to weathering and ageing	Gute Witterungs- und Alterungsbeständigkeit Good resistance to weathering and ageing	Sehr gute Witterungsbeständigkeit Very good resistance to weathering
<b>Thermische Werte dauernd</b> Permanent thermal conditions	-60°C / +200°C	-60°C / +200°C	-60°C / +200°C	-60°C / +200°C	-60°C / +200°C	-30°C / +105°C
<b>Brennbarkeit</b> Combustibility	Nicht brennbar Non-combustible	Nicht brennbar Non-combustible	Nicht brennbar Non-combustible	Nicht brennbar Non-combustible	Nicht brennbar Non-combustible	Nicht brennbar Non-combustible

Bei speziellen Anwendungen bitten wir um Ihre schriftliche Anfrage.

In case of special applications, we kindly ask you to send us your written request.



# Materialübersichtstabelle – Kunststoffe

## Materials overview – Elastomeric materials

Produkt Product	Agromid	PA GFK PA GFK (GRP)	PA	Polyester
<b>Bezeichnung</b>	Polyamid PA6 GF30, glasfaserverstärkt, schlagzäh, wärmestabilisiert	Polyamid PA6 GF30, glasfaserverstärkt	Polyamid PA6	Polyester PET
<b>Designation</b>	Polyamide PA6 GF30, glass-fiber reinforced, impact resistant, heat-stabilized	Polyamide PA6 GF30, glass-fibre reinforced	Polyamide PA6	Polyester PET
<b>Farbe</b> <b>Colour</b>	Nach Katalog See catalogue	Nach Katalog See catalogue	Nach Katalog See catalogue	Nach Katalog See catalogue
<b>Chem. Beständigkeit</b>	Beständig gegen verdünnte organische Säuren, Laugen, wässrige Lösungen von anorganischen Salzen, Mineralöle, Kraftstoffe, Kühl- und Schneideöle			Gute Beständigkeit gegen Wasser (bei Raumtemperatur), verdünnte Säuren, neutrale und saure Salze, Alkohol, Ether, Öle, Fette, perchlorierte und aromatische Kohlenwasserstoffe
<b>Chemical resistance</b>	Resistant against diluted organic acids, alkaline solutions, aqueous inorganic saline solutions, mineral oils, motor fuels, cooling and cutting oils			Good resistance to water (room temperature), diluted acids, neutral and acid salts, alcohol, ethers, oils, greases, perchlorinated and aromatic hydrocarbons
<b>Bedingt bzw. nicht beständig</b>	Mineralsäuren, konzentrierte organische Säuren, Ameisensäure, Phenole, Halogene			Alkalien, überhitzten Dampf, Ketone, Phenole, Ester, oxidierende Säuren und Kohlenwasserstoffe, Ammoniak
<b>Non-resistant or only partially resistant</b>	Mineral acids, concentrated organic acids, formic acids, phenols, halogens			Alkalis, superheated steam, ketones, phenols, esters, oxidising acids and hydrocarbons, ammonia
<b>Witterungsbeständigkeit</b>	Gute Witterungs- und Alterungsbeständigkeit	Gute Witterungsbeständigkeit	Gute Witterungsbeständigkeit, in schwarz UV-beständig (getestet nach EN ISO 4892-2)	Gute Witterungsbeständigkeit
<b>Resistance to weathering</b>	Good resistance to weathering and ageing	Good resistance to weathering	Good weather resistance, in black UV-resistant (tested according to EN ISO 4892-2)	Good resistance to weathering
<b>Thermische Werte dauernd</b> <b>Permanent thermal conditions</b>	-30°C / +100°C	-20°C / +100°C	-30°C / +100°C	-50°C / +150°C
<b>Brennbarkeit</b>	Vergleichbar UL 94 HB Halogenfrei	Vergleichbar UL 94 HB Halogenfrei	UL 94 V-2 Halogenfrei	EN 45545-2 (R22/R23) HL3 Halogenfrei
<b>Combustibility</b>	Comparable UL 94 HB Halogen-free	Comparable UL 94 HB Halogen-free	UL 94 V-2 Halogen-free	EN 45545-2 (R22/R23) HL3 Halogen-free

Bei speziellen Anwendungen bitten wir um Ihre schriftliche Anfrage.

In case of special applications, we kindly ask you to send us your written enquiry.

# Materialübersichtstabelle – Elastomere

## Materials overview – Elastomeric materials

Produkt Product	TPE	Spezial AGRO TPE Special AGRO TPE	NBR	FPM / FKM
<b>Bezeichnung</b>	Thermoplastisches Elastomer	Thermoplastisches Elastomer, Spezial Compound	Acrylnitril-Butadien-Kautschuk	Fluor-Kautschuk
<b>Designation</b>	Thermoplastic elastomers	Thermoplastic elastomers, special compound	Acrylonitrile-butadiene rubber	Fluorine-rubber
<b>Farbe Colour</b>	Schwarz Black	Hellgrau RAL 7035 Light grey RAL 7035	Schwarz Black	Grün Green
<b>Chem. Beständigkeit</b>	Beständig gegen verdünnte Säuren und Laugen, wässrige Lösungen von anorganischen Salzen	Gut beständig gegen verdünnte Säuren und Laugen, wässrige Lösungen von anorganischen Salzen, Heisswasser sowie Meereswasser	Beständig gegen verdünnte Säuren und Laugen, wässrige Lösungen von anorganischen Salzen, Mineralöle, Kraftstoffe, Kühl- und Schneidöle	Beständig gegen die meisten Säuren und Laugen, wässrige Lösungen von anorganischen Salzen, Mineralöle, Kraftstoffe, Kühl- und Schneidöle
<b>Chemical resistance</b>	Resistant against diluted acids and alkaline solutions and against aqueous solutions of inorganic salts	High resistance against diluted acids and alkaline solutions, aqueous solutions of inorganic salts, hot water and seawater	Resistant against diluted acids and alkaline solutions, aqueous solutions of inorganic salts, mineral oils, motor fuels, cooling and cutting oils	Resistant against most acids and alkaline solutions, aqueous solutions of inorganic salts, mineral oils, motor fuels, cooling and cutting oils
<b>Bedingt bzw. nicht beständig</b>	Konzentrierte Säuren und Laugen, Lösungsmittel, Kraftstoffe, Mineral-, Kühl- und Schneidöle	Nicht beständig gegen konzentrierte Säuren und Laugen, Lösungsmittel und Kraftstoffe	Konzentrierte Säuren und Laugen, Lösungsmittel, Ozon	Konzentrierte Laugen
<b>Non-resistant or only partially resistant</b>	Concentrated acids and alkaline solutions, solvents, motor fuels, mineral, cooling and cutting oils	Not resistant to concentrated acids and alkaline solutions, solvents and motor fuels	Concentrated acids and alkaline solutions, solvents, ozone	Concentrated alkaline solutions
<b>Witterungsbeständigkeit</b>	Gute Witterungs-, Ozon- und Alterungsbeständigkeit	Gute Witterungs-, Ozon- und Alterungsbeständigkeit	Gute Witterungsbeständigkeit	Sehr gute Witterungs-, Ozon- und Alterungsbeständigkeit
<b>Resistance to weathering</b>	Good resistance to weathering, ozone and ageing	Good resistance to weathering, ozone and ageing	Good resistance to weathering	Very good resistance to weathering, ozone and ageing
<b>Thermische Werte dauernd Permanent thermal conditions</b>	-40°C / + 100°C - 60°C (Ex)	-50°C / +105°C	-40°C / +100°C -60°C (Ex)	-40°C / +200°C
<b>Brennbarkeit</b>	UL 94 HB halogenfrei	EN 45545-2 / HL3 (R22/R23) EN 45545-3 / E30 halogenfrei	vergleichbar UL 94 HB halogenfrei	vergleichbar UL 94 V-2
<b>Combustibility</b>	UL 94 HB Halogen-free	EN 45545-2 / HL3 (R22/R23) EN 45545-3 / E30 Halogen-free	comparable UL 94 HB Halogen-free	comparable UL 94 V-2

Bei speziellen Anwendungen bitten wir um Ihre schriftliche Anfrage.

In case of special applications, we kindly ask you to send us your written enquiry.

# Materialübersichtstabelle – Elastomere

## Materials overview – Elastomeric materials

Produkt Product	FPM / FKM	EPDM	CR
<b>Bezeichnung</b> Designation	Fluor-Kautschuk Fluorine rubber	Ethylen-Propylen-Terpolymere-Kautschuk ethylene propylene diene monomer rubber	Chloropren-Kautschuk Chloroprene rubber
<b>Farbe</b> Colour	Blau Blue	Nach Katalog See catalogue	Schwarz Black
<b>Chem. Beständigkeit</b> Chemical resistance	Beständig gegen die meisten Säuren und Laugen, wässrige Lösungen von anorganischen Salzen, Mineralöle, Kraftstoffe, Kühl- und Schneidöle FDA konform Resistant against most acids and alkaline solutions, aqueous solutions of inorganic salts, mineral oils, motor fuels, cooling and cutting oils In conformity with FDA requirements.	Heisswasser, wässrige Lösungen von anorganischen Salzen, verdünnte Säuren und Laugen Hot water, aqueous solutions of inorganic salts, diluted acids and alkaline solutions	Beständig gegen verdünnte Säuren und Laugen, wässrige Lösungen von anorganischen Salzen, Mineral-, Kühl- und Schneidöle Resistant against diluted acids and alkaline solutions, aqueous solutions of inorganic salts, mineral oils, cooling oils and cutting oils
<b>Bedingt bzw. nicht beständig</b> Non-resistant or only partially resistant	Konzentrierte Laugen Concentrated alkaline solutions	Mineralöle, Kraft- und Treibstoffe, konzentrierte Säuren und Laugen, Ester Mineral oils, motor fuels and propellants, concentrated acids and alkaline solutions, esters	Konzentrierte Säuren und Laugen, Lösungsmittel, Kraftstoffe, Heisswasser, Ozon Concentrated acids and alkaline solutions, solvents, motor fuels, hot water, ozone
<b>Witterungsbeständigkeit</b> Resistance to weathering	Sehr gute Witterungs-, Ozon- und Alterungsbeständigkeit Very good resistance to weathering, ozone and ageing	Gute Witterungs-, Ozon- und Alterungsbeständigkeit Good resistance to weathering, ozone and ageing	Gute Witterungsbeständigkeit Good resistance to weathering
<b>Thermische Werte dauernd</b> Permanent thermal conditions	-40°C / +200°C	-40°C / +80°C (KTW W270) -40°C / +100°C -40°C / +110°C	-30°C / +100°C
<b>Brennbarkeit</b> Combustibility	Vergleichbar UL94 V-2 Comparable UL 94 V-2 Halogen-free	Vergleichbar UL 94 HB halogenfrei Comparable UL 94 HB Halogen-free	Vergleichbar UL 94 HB Comparable UL 94 HB

Bei speziellen Anwendungen bitten wir um Ihre schriftliche Anfrage.  
In case of special applications, we kindly ask you to send us your written enquiry.

# Vergleich rostfreier und säurebeständiger Stahl A4

## Comparison of stainless and acid-resistant steel A4



Edelstahl rostfrei ist der Sammelbegriff für nichtrostende Stähle, die sich durch besondere Beständigkeit gegen chemisch angreifende Stoffe auszeichnen. Sie haben einen Massenanteil von 10,5 % Chrom (Cr) und von höchstens 1,2 % Kohlenstoff (C). Ein höherer Chromgehalt und der Zusatz weiterer Legierungselemente wie Nickel (Ni), Molybdän (Mo), Mangan (Mn) und Kupfer (Cu) verbessern die Korrosionsstabilität, verändern aber auch die mechanischen Eigenschaften.

Wir vergleichen hier die beiden rostfreien und säurebeständigen Stähle DIN EN 1.4404 und DIN EN 1.4435. Beide sind eine beliebte Wahl für Kabelverschraubungen mit hohen Ansprüchen an die Korrosionsbeständigkeit.

Der von AGRO AG verwendete Stahl A4 mit der Werkstoffnummer DIN EN 1.4435 (AISI 316L) ist eine höher legierte Variante des DIN EN 1.4404. Er weist in natürlichen Umweltmedien wie Salzwasser, ländlichen und städtischen Atmosphären, in Industriegebieten mit gemäßigten Chlor- und Salzkonzentrationen sowie im Bereich der Nahrungsmittelproduktion eine ausgezeichnete Korrosionsbeständigkeit auf. Aufgrund des höheren Chrom-, Nickel- und Molybdän-Anteils ist der DIN EN 1.4435 im Vergleich zu anderen A4 Stählen in der Säurebeständigkeit unübertroffen. Der massgebende Molybdän-Anteil verbessert besonders die Beständigkeit gegen Chlorid, Schwefelsäure und organische Säuren.

### Technische Daten

Stahl Steel	C (%)	Cr (%)	Ni (%)	Mo (%)	Mn (%)	Cu (%)	Si (%)	P (%)	S (%)
<b>DIN 1.4435 (AGRO) (AISI 316L)</b>	≤ 0.03	17.0 - 19.0	12.5 - 15.0	2.5 - 3.5	≤ 2.0	0.11	≤ 1.0	≤ 0.045	≤ 0.015
<b>DIN 1.4404 (AISI 316L)</b>	≤ 0.03	16.5 - 18.5	10.0 - 13.0	2.0 - 2.5	≤ 2.0	0	≤ 1.0	≤ 0.045	≤ 0.015

### Anwendungsgebiete

Der Werkstoff DIN EN 1.4435 kann sehr gut in chemischen Anlagen, für medizinischen Anwendungen, in der pharmazeutischen Industrie, der Lebensmittelherstellung sowie der Vakuumtechnik eingesetzt werden. Dank seiner aussergewöhnlichen Korrosionsbeständigkeit ist dieser Stahl auch optimal für die Schwimmbadtechnik und in Kläranlagen geeignet.

Stainless steel is a general term for non-rusting steels that are characterised by particularly good resistance against chemically aggressive substances. They contain minimum 10.5% chromium (Cr) by weight, and maximum 1.2% carbon (C). A higher chromium content and the addition of further alloying elements such as nickel (Ni), molybdenum (Mo), manganese (Mn) and copper (Cu) improve corrosion resistance, but also change the material's mechanical properties.

Here, we compare two rust- and acid-proof steels: DIN EN 1.4404 and DIN EN 1.4435. Both are widely used for cable glands with high demands in relation to corrosion resistance.

The A4 steel used by AGRO AG, with the material number DIN EN 1.4435 (AISI 316L), is a more highly alloyed variation of type DIN EN 1.4404. It exhibits excellent corrosion resistance in natural environmental media such as saltwater, in rural and urban atmospheres, in industrial areas with moderate concentrations of chlorine and salt, and in the field of food production. Due to its higher chromium, nickel and molybdenum contents, type DIN EN 1.4435 is unsurpassed by other A4 steels in terms of resistance to acids. The significant presence of molybdenum particularly improves the resistance to chlorides, sulphuric acid and organic acids.

### Technical details

### Application areas

The material DIN EN 1.4435 finds good application in chemical facilities, for medical uses, in the pharmaceutical industry, in food production and in vacuum technology. Thanks to its exceptional corrosion resistance, this type of steel is also ideally suited to use in swimming pool technology and in wastewater treatment or water purification plants.

Art.-No. Art.-No.	Seite Page	Art.-No. Art.-No.	Seite Page	Art.-No. Art.-No.	Seite Page
<b>10...</b>		1000.10.98.30.03	293	1000.16.25.30.91	41
1000.06.025	16	1000.100.30.03	292	1000.16.30	40
1000.06.030	16	1000.100.850	16	1000.16.30.91	41
1000.06.035	16	1000.105.30.03	292	1000.16.85.120	110
1000.06.30	40	1000.105.900	16	1000.16.85.150	110
1000.06.30.03	292	1000.11	23	1000.16.91.150	32
1000.06.30.91	41	1000.11.055	22	1000.16.92	32
1000.06.91.025	30	1000.11.085	22	1000.17	17
1000.06.91.030	30	1000.11.120	22	1000.17.045	16
1000.06.91.035	30	1000.11.20.30	40	1000.17.045LF	200
1000.06.98.30.03	293	1000.11.20.30.91	41	1000.17.060	16
1000.07.050	22	1000.11.30	40	1000.17.060LF	200
1000.07.065	22	1000.11.30.03	292	1000.17.080	16
1000.07.080	22	1000.11.30.91	41	1000.17.080LF	200
1000.07.30	40	1000.11.85.080	110	1000.17.105	16
1000.07.30.91	41	1000.11.85.120	110	1000.17.105LF	200
1000.07.91.050	32	1000.11.91.120	32	1000.17.30	40
1000.07.91.065	32	1000.11.92	32	1000.17.30.03	292
1000.07.91.080	32	1000.11.98.30.03	293	1000.17.30.91	41
1000.08.035	16	1000.11/2G	29	1000.17.85.045	109
1000.08.050	16	1000.11/2NPT	28	1000.17.85.080	109
1000.08.30	40	1000.11/2NPT.330	28	1000.17.85.100	109
1000.08.30.03	292	1000.11/2NPT.370	28	1000.17.91.105	30
1000.08.30.91	41	1000.11/2NPT.410	28	1000.17.92	30
1000.08.91.035	30	1000.11/4NPT	28	1000.17.98.30.03	293
1000.08.91.050	30	1000.11/4NPT.240	28	1000.17LF	200
1000.08.98.30.03	293	1000.11/4NPT.285	28	1000.1G	29
1000.085.30.03	292	1000.11/4NPT.330	28	1000.1NPT	28
1000.09	23	1000.115.30.03	292	1000.1NPT.170	28
1000.09.00.08	294	1000.115.950	16	1000.1NPT.210	28
1000.09.045	22	1000.12.050	16	1000.1NPT.255	28
1000.09.060	22	1000.12.050LF	200	1000.20	17
1000.09.080	22	1000.12.065	16	1000.20.045G	18
1000.09.105	22	1000.12.065LF	200	1000.20.065G	18
1000.09.30	40	1000.12.080	16	1000.20.080	16
1000.09.30.91	41	1000.12.080LF	200	1000.20.080G	18
1000.09.91.105	32	1000.12.30	40	1000.20.080LF	200
1000.09.92	32	1000.12.30.03	292	1000.20.110	16
1000.095.30.03	292	1000.12.30.91	41	1000.20.110LF	200
1000.1/2G	29	1000.12.91.050	30	1000.20.150	16
1000.1/2NPT	28	1000.12.91.065	30	1000.20.150LF	200
1000.1/2NPT.080	28	1000.12.91.080	30	1000.20.30	40
1000.1/2NPT.110	28	1000.12.98.30.03	293	1000.20.30.03	292
1000.1/2NPT.150	28	1000.13	23	1000.20.30.91	41
1000.1/4NPT.050	28	1000.13.080	22	1000.20.85.120	109
1000.1/4NPT.065	28	1000.13.110	22	1000.20.85.140	109
1000.1/4NPT.080	28	1000.13.150	22	1000.20.91.150	30
1000.1/8NPT.040	28	1000.13.30	40	1000.20.92	30
1000.1/8NPT.060	28	1000.13.30.91	41	1000.20.98.30.03	293
1000.10.040	16	1000.13.91.150	32	1000.20LF	200
1000.10.060	16	1000.13.92	32	1000.21	23
1000.10.30	40	1000.16	23	1000.21.125	22
1000.10.30.03	292	1000.16.080	22	1000.21.160	22
1000.10.30.91	41	1000.16.110	22	1000.21.205	22
1000.10.91.040	30	1000.16.150	22	1000.21.30	40
1000.10.91.060	30	1000.16.25.30	40	1000.21.30.91	41

Art.-No. Art.-No.	Seite Page	Art.-No. Art.-No.	Seite Page	Art.-No. Art.-No.	Seite Page
1000.21.32.30	40	1000.3/8NPT.105	28	1000.42.330	22
1000.21.32.30.91	41	1000.32	17	1000.42.370	22
1000.21.85.160	110	1000.32.045G	18	1000.42.420	22
1000.21.85.190	110	1000.32.065G	18	1000.42.91.420	32
1000.21.91.205	32	1000.32.080G	18	1000.42.92	32
1000.21.92	32	1000.32.170	16	1000.48	23
1000.21/2G.500	29	1000.32.170LF	200	1000.48.00.08	294
1000.21/2G.560	29	1000.32.210	16	1000.48.30	40
1000.25	17	1000.32.210LF	200	1000.48.30.03	292
1000.25.045G	18	1000.32.255	16	1000.48.30.91	41
1000.25.065G	18	1000.32.255LF	200	1000.48.370	22
1000.25.080G	18	1000.32.30	40	1000.48.430	22
1000.25.125	16	1000.32.30.03	292	1000.48.490	22
1000.25.125LF	200	1000.32.30.91	41	1000.48.91.490	32
1000.25.160	16	1000.32.85.220	109	1000.48.92	32
1000.25.160LF	200	1000.32.85.250	109	1000.48.98.30.03	293
1000.25.205	16	1000.32.91.255	30	1000.50	17
1000.25.205LF	200	1000.32.92	30	1000.50.00.08	294
1000.25.30	40	1000.32.98.30.03	293	1000.50.30	40
1000.25.30.03	292	1000.32LF	200	1000.50.30.03	292
1000.25.30.91	41	1000.36	23	1000.50.30.91	41
1000.25.85.160	109	1000.36.260	22	1000.50.330	16
1000.25.85.190	109	1000.36.30	40	1000.50.330LF	200
1000.25.91.205	30	1000.36.30.03	292	1000.50.370	16
1000.25.92	30	1000.36.30.91	41	1000.50.370LF	200
1000.25.98.30.03	293	1000.36.305	22	1000.50.420	16
1000.25LF	200	1000.36.350	22	1000.50.420LF	200
1000.29	23	1000.36.50.30	40	1000.50.85.380	109
1000.29.190	22	1000.36.50.30.91	41	1000.50.91.420	30
1000.29.230	22	1000.36.91.350	32	1000.50.92	30
1000.29.275	22	1000.36.92	32	1000.50.98.30.03	293
1000.29.30	40	1000.36.98.30.03	293	1000.50LF	200
1000.29.30.03	292	1000.3G.630	29	1000.63	17
1000.29.30.91	41	1000.3G.700	29	1000.63.00.08	294
1000.29.40.30	40	1000.40	17	1000.63.30	40
1000.29.40.30.91	41	1000.40.00.08	294	1000.63.30.03	292
1000.29.85.220	110	1000.40.065G	18	1000.63.30.91	41
1000.29.85.250	110	1000.40.080G	18	1000.63.400	16
1000.29.91.275	32	1000.40.240	16	1000.63.400LF	200
1000.29.92	32	1000.40.240LF	200	1000.63.460	16
1000.29.98.30.03	293	1000.40.285	16	1000.63.460LF	200
1000.2G	29	1000.40.285LF	200	1000.63.520	16
1000.2NPT	28	1000.40.30	40	1000.63.520LF	200
1000.2NPT.400	28	1000.40.30.03	292	1000.63.85.380	109
1000.2NPT.460	28	1000.40.30.91	41	1000.63.85.440	109
1000.2NPT.520	28	1000.40.330	16	1000.63.91.520	30
1000.3/4G	29	1000.40.330LF	200	1000.63.92	30
1000.3/4NPT	28	1000.40.85.300	109	1000.63.98.30.03	293
1000.3/4NPT.125	28	1000.40.91.330	30	1000.63LF	200
1000.3/4NPT.160	28	1000.40.92	30	1000.75	17
1000.3/4NPT.205	28	1000.40.98.30.03	293	1000.75.00.08	294
1000.3/8G	29	1000.40LF	200	1000.75.30.03	292
1000.3/8NPT	28	1000.42	23	1000.75.500	16
1000.3/8NPT.045	28	1000.42.00.08	294	1000.75.560	16
1000.3/8NPT.060	28	1000.42.30	40	1000.75.630	16
1000.3/8NPT.080	28	1000.42.30.91	41	1000.85.700	16

Art.-No. Art.-No.	Seite Page	Art.-No. Art.-No.	Seite Page	Art.-No. Art.-No.	Seite Page
1000.95.750	16	1025.00.19	298	1045.32.210	238
1000.95.800	16	1025.45.16	297	1045.40.230	238
1005.00.08	294	1025.52	47	1045.40.280	238
1006.00.08	294	1025.80.10	112	1045.50.290	238
1006.00.16	296	1029.00.08	294	1045.50.350	238
1006.06.08	294	1029.00.16	296	1045.63.390	238
1007.00.08	294	1029.00.19	298	1045.63.480	238
1007.00.16	296	1029.45.16	297	1048.00.16	296
1007.45.16	297	1029.80.10	112	1050.00.16	296
1007.52	47	1032.00.16	296	1050.00.19	298
1007.80.10	112	1032.00.19	298	1050.45.16	297
1008.00.16	296	1032.45.16	297	1050.80.10	112
1008.52	47	1032.80.10	112	1060.06.025	17
1009.00.16	296	1036.00.08	294	1060.06.030	17
1009.45.16	297	1036.00.16	296	1060.07.050	24
1009.52	47	1036.00.19	298	1060.07.065	24
1010.00.16	296	1036.45.16	297	1060.07.075	24
1010.52	47	1036.80.10	112	1060.07.52.050	49
1011.00.08	294	1040.00.16	296	1060.07.52.065	49
1011.00.16	296	1040.00.19	298	1060.07.52.075	49
1011.00.19	298	1040.17.40.065	74	1060.08.030	17
1011.45.16	297	1040.17.40.080	74	1060.08.040	17
1011.52	47	1040.17.96.30.065	75	1060.08.52.030	48
1011.80.10	112	1040.17.96.30.080	75	1060.08.52.040	48
1012.00.16	296	1040.17.96.70.065	75	1060.09	24
1012.00.19	298	1040.17.96.70.080	75	1060.09.060	24
1012.45.16	297	1040.20.40.080	74	1060.09.080	24
1012.52	47	1040.20.40.105	74	1060.09.105	24
1013.00.16	296	1040.20.96.30.080	75	1060.09.52	49
1013.00.22.08	294	1040.20.96.30.105	75	1060.09.52.060	49
1013.45.16	297	1040.20.96.70.080	75	1060.09.52.080	49
1013.51	47	1040.20.96.70.105	75	1060.09.52.105	49
1013.52	47	1040.25.40.110	74	1060.10.040	17
1016.00.08	294	1040.25.40.150	74	1060.10.060	17
1016.00.16	296	1040.25.96.30.110	75	1060.10.52.040	48
1016.00.25.08	294	1040.25.96.30.150	75	1060.10.52.060	48
1016.45.16	297	1040.25.96.70.110	75	1060.11	24
1016.51	47	1040.25.96.70.150	75	1060.11.055	24
1016.52	47	1040.32.40.160	74	1060.11.085	24
1016.80.10	112	1040.32.40.205	74	1060.11.120	24
1017.00.16	296	1040.32.96.30.160	75	1060.11.52	49
1017.00.19	298	1040.32.96.30.205	75	1060.11.52.060	49
1017.45.16	297	1040.32.96.70.160	75	1060.11.52.080	49
1017.52	47	1040.32.96.70.205	75	1060.11.52.105	49
1017.80.10	112	1040.45.16	297	1060.12.050	17
1020.00.19	298	1040.80.10	112	1060.12.065	17
1020.45.16	297	1042.00.16	296	1060.12.075	17
1020.51	47	1045.12.050	238	1060.12.52.050	48
1020.52	47	1045.12.070	238	1060.12.52.065	48
1020.80.10	112	1045.17.060	238	1060.12.52.075	48
1021.00.16	296	1045.17.100	238	1060.13	24
1021.00.30.08	294	1045.20.080	238	1060.13.080	24
1021.45.16	297	1045.20.130	238	1060.13.110	24
1021.51	47	1045.25.110	238	1060.13.145	24
1021.80.10	112	1045.25.170	238	1060.13.52	49
1025.00.16	296	1045.32.150	238	1060.13.52.080	49

Art.-No. Art.-No.	Seite Page	Art.-No. Art.-No.	Seite Page	Art.-No. Art.-No.	Seite Page
1060.13.52.110	49	1060.40.330	17	1080.13.52.110	107
1060.13.52.145	49	1060.42	24	1080.13.52.140	107
1060.16	24	1060.42.370	24	1080.13.91.110	105
1060.16.080	24	1060.42.420	24	1080.13.91.140	105
1060.16.110	24	1060.48	24	1080.16.110	102
1060.16.145	24	1060.48.430	24	1080.16.140	102
1060.16.52	49	1060.48.490	24	1080.16.52.110	107
1060.16.52.080	49	1060.50	18	1080.16.52.140	107
1060.16.52.110	49	1060.50.370	17	1080.16.91.110	105
1060.16.52.145	49	1060.50.420	17	1080.16.91.140	105
1060.17	18	1060.63	18	1080.17.080	100
1060.17.060	17	1060.63.460	17	1080.17.080LF	203
1060.17.080	17	1060.63.520	17	1080.17.100	100
1060.17.105	17	1060.75	18	1080.17.100LF	203
1060.17.52	48	1060.75.560	17	1080.17.52.080	106
1060.17.52.060	48	1060.75.630	17	1080.17.52.100	106
1060.17.52.080	48	1063.00.16	296	1080.17.91.080	104
1060.17.52.105	48	1063.00.19	298	1080.17.91.100	104
1060.20	18	1063.45.16	297	1080.20.110	100
1060.20.080	17	1063.80.10	112	1080.20.110LF	203
1060.20.110	17	1080.07.060	102	1080.20.140	100
1060.20.145	17	1080.07.075	102	1080.20.140LF	203
1060.20.52	48	1080.07.52.060	107	1080.20.52.110	106
1060.20.52.080	48	1080.07.52.075	107	1080.20.52.140	106
1060.20.52.110	48	1080.08.035	100	1080.20.91.110	104
1060.20.52.145	48	1080.08.040	100	1080.20.91.140	104
1060.21	24	1080.08.52.035	106	1080.21.160	102
1060.21.125	24	1080.08.52.040	106	1080.21.190	102
1060.21.160	24	1080.09.080	102	1080.21.52.160	107
1060.21.190	24	1080.09.100	102	1080.21.52.190	107
1060.21.52	49	1080.09.52.080	107	1080.21.91.160	105
1060.21.52.125	49	1080.09.52.100	107	1080.21.91.190	105
1060.21.52.160	49	1080.09.91.080	105	1080.25.160	100
1060.21.52.190	49	1080.09.91.100	105	1080.25.160LF	203
1060.25	18	1080.10.040	100	1080.25.190	100
1060.25.125	17	1080.10.060	100	1080.25.190LF	203
1060.25.160	17	1080.10.52.040	106	1080.25.52.160	106
1060.25.190	17	1080.10.52.060	106	1080.25.52.190	106
1060.25.52	48	1080.10.91.040	104	1080.25.91.160	104
1060.25.52.125	48	1080.10.91.060	104	1080.25.91.190	104
1060.25.52.160	48	1080.11.085	102	1080.29.230	102
1060.25.52.190	48	1080.11.120	102	1080.29.255	102
1060.29	24	1080.11.52.080	107	1080.29.91.230	105
1060.29.230	24	1080.11.52.100	107	1080.29.91.255	105
1060.29.275	24	1080.11.91.085	105	1080.32.210	100
1060.32	18	1080.11.91.120	105	1080.32.210LF	203
1060.32.210	17	1080.12.060	100	1080.32.250	100
1060.32.255	17	1080.12.060LF	203	1080.32.250LF	203
1060.32.52	48	1080.12.075	100	1080.32.52.210	106
1060.32.52.210	48	1080.12.075LF	203	1080.32.52.245	106
1060.32.52.245	48	1080.12.52.060	106	1080.32.91.210	104
1060.36	24	1080.12.52.075	106	1080.32.91.250	104
1060.36.305	24	1080.12.91.060	104	1080.36.305	102
1060.36.350	24	1080.12.91.075	104	1080.36.350	102
1060.40	18	1080.13.110	102	1080.40.285	100
1060.40.285	17	1080.13.140	102	1080.40.285LF	203

Art.-No. Art.-No.	Seite Page	Art.-No. Art.-No.	Seite Page	Art.-No. Art.-No.	Seite Page
1080.40.320	100	1083.25LF	202	1089.20.97.098.03	118
1080.40.320LF	203	1083.32	95	1089.20.97.103.03	118
1080.42.370	102	1083.32.96	96	1089.20.97.114.03	118
1080.42.410	102	1083.32LF	202	1089.20.97.124.03	118
1080.48.430	102	1083.40	95	1089.20.97.132.03	118
1080.48.465	102	1083.40.96	96	1089.20.97.139.03	118
1080.50.370	100	1083.40LF	202	1089.20.97.146.03	118
1080.50.370LF	203	1083.50	95	1089.200.05.R1	121
1080.50.410	100	1083.50.96	96	1089.210.05.R1	121
1080.50.410LF	203	1083.50LF	202	1089.227.05.R1	121
1080.63.460	100	1083.63	95	1089.231.05.R1	121
1080.63.460LF	203	1083.63.96	96	1089.25.01LF	118
1080.63.500	100	1083.63LF	202	1089.25.02LF	119
1080.63.500LF	203	1084.17	108	1089.25.132.04.R1	120
1080.75.560	100	1084.20	108	1089.25.132.SETAR1	116
1080.80.650	100	1084.25	108	1089.25.139.04.R1	120
1080.85.700	100	1084.32	108	1089.25.139.SETAR1	116
1080.95.750	100	1084.40	108	1089.25.146.04.R1	120
1081.07.060	99	1084.50	108	1089.25.146.SETAR1	116
1081.07.075	99	1084.63	108	1089.25.154.04.R1	120
1081.09.080	99	1084.75	108	1089.25.154.SETAR1	116
1081.09.100	99	1084.80.650	108	1089.25.160.04.R1	120
1081.11.085	99	1084.85.700	108	1089.25.160.SETAR1	116
1081.11.120	99	1089.090.05.R1	121	1089.25.168.04.R1	120
1081.12.060	98	1089.098.05.R1	121	1089.25.168.SETAR1	116
1081.12.075	98	1089.103.05.R1	121	1089.25.175.04.R1	120
1081.13.110	99	1089.114.05.R1	121	1089.25.175.SETAR1	116
1081.13.140	99	1089.124.05.R1	121	1089.25.184.04.R1	120
1081.16.110	99	1089.132.05.R1	121	1089.25.184.SETAR1	116
1081.16.140	99	1089.139.05.R1	121	1089.25.25	119
1081.17.080	98	1089.146.05.R1	121	1089.25.97.132.03	118
1081.17.100	98	1089.154.05.R1	121	1089.25.97.139.03	118
1081.20.110	98	1089.160.05.R1	121	1089.25.97.146.03	118
1081.20.140	98	1089.168.05.R1	121	1089.25.97.154.03	118
1081.21.160	99	1089.175.05.R1	121	1089.25.97.160.03	118
1081.21.190	99	1089.184.05.R1	121	1089.25.97.168.03	118
1081.25.160	98	1089.20.01LF	118	1089.25.97.175.03	118
1081.25.190	98	1089.20.02LF	119	1089.25.97.184.03	118
1081.29.230	99	1089.20.090.04.R1	120	1089.32.01LF	118
1081.29.255	99	1089.20.090.SETAR1	116	1089.32.02LF	119
1081.32.210	98	1089.20.098.04.R1	120	1089.32.175.04.R1	120
1081.32.250	98	1089.20.098.SETAR1	116	1089.32.175.SETAR1	116
1083.12.050	95	1089.20.103.04.R1	120	1089.32.184.04.R1	120
1083.12.050LF	202	1089.20.103.SETAR1	116	1089.32.184.SETAR1	116
1083.12.065	95	1089.20.114.04.R1	120	1089.32.200.04.R1	120
1083.12.065LF	202	1089.20.114.SETAR1	116	1089.32.200.SETAR1	116
1083.12.96.050	96	1089.20.124.04.R1	120	1089.32.210.04.R1	120
1083.12.96.065	96	1089.20.124.SETAR1	116	1089.32.210.SETAR1	116
1083.17	95	1089.20.132.04.R1	120	1089.32.227.04.R1	120
1083.17.96	96	1089.20.132.SETAR1	116	1089.32.227.SETAR1	116
1083.17LF	202	1089.20.139.04.R1	120	1089.32.231.04.R1	120
1083.20	95	1089.20.139.SETAR1	116	1089.32.231.SETAR1	116
1083.20.96	96	1089.20.146.04.R1	120	1089.32.32	119
1083.20LF	202	1089.20.146.SETAR1	116	1089.32.97.175.03	118
1083.25	95	1089.20.20	119	1089.32.97.184.03	118
1083.25.96	96	1089.20.97.090.03	118	1089.32.97.200.03	118

Art.-No. Art.-No.	Seite Page	Art.-No. Art.-No.	Seite Page	Art.-No. Art.-No.	Seite Page
1089.32.97.210.03	118	1100.10.96.040	64	1100.16.94.150	63
1089.32.97.227.03	118	1100.10.96.060	64	1100.16.96	65
1089.32.97.231.03	118	1100.10.98.040	66	1100.16.96.150	65
1089.40.40	119	1100.10.98.060	66	1100.16.98	67
<b>11...</b>		1100.11	26	1100.16.98.150	67
1100.06.025	19	1100.11.055	25	1100.17	20
1100.06.030	19	1100.11.085	25	1100.17.045	19
1100.06.035	19	1100.11.120	25	1100.17.045LF	201
1100.06.91.025	31	1100.11.50	45	1100.17.060	19
1100.06.91.030	31	1100.11.91.120	33	1100.17.060LF	201
1100.06.91.035	31	1100.11.92	33	1100.17.080	19
1100.07.050	25	1100.11.94	63	1100.17.080LF	201
1100.07.065	25	1100.11.94.120	63	1100.17.105	19
1100.07.080	25	1100.11.96	65	1100.17.105LF	201
1100.07.91.050	33	1100.11.96.120	65	1100.17.50	45
1100.07.91.065	33	1100.11.98	67	1100.17.51	45
1100.07.91.080	33	1100.11.98.120	67	1100.17.91.105	31
1100.07.94.050	63	1100.12.050	19	1100.17.92	31
1100.07.94.065	63	1100.12.050LF	201	1100.17.94	62
1100.07.94.080	63	1100.12.065	19	1100.17.94.105	62
1100.07.96.050	65	1100.12.065LF	201	1100.17.96	64
1100.07.96.065	65	1100.12.080	19	1100.17.96.105	64
1100.07.96.080	65	1100.12.080LF	201	1100.17.98	66
1100.07.98.050	67	1100.12.91.050	31	1100.17.98.105	66
1100.07.98.065	67	1100.12.91.065	31	1100.17LF	201
1100.07.98.080	67	1100.12.91.080	31	1100.20	20
1100.08.035	19	1100.12.94.050	62	1100.20.045G	20
1100.08.050	19	1100.12.94.065	62	1100.20.065G	20
1100.08.91.035	31	1100.12.94.080	62	1100.20.080	19
1100.08.91.050	31	1100.12.96.050	64	1100.20.080G	20
1100.08.94.035	62	1100.12.96.065	64	1100.20.080LF	201
1100.08.94.050	62	1100.12.96.080	64	1100.20.110	19
1100.08.96.035	64	1100.12.98.050	66	1100.20.110LF	201
1100.08.96.050	64	1100.12.98.065	66	1100.20.150	19
1100.08.98.035	66	1100.12.98.080	66	1100.20.150LF	201
1100.08.98.050	66	1100.13	26	1100.20.50	45
1100.09	26	1100.13.080	25	1100.20.51	45
1100.09.045	25	1100.13.110	25	1100.20.91.150	31
1100.09.060	25	1100.13.150	25	1100.20.92	31
1100.09.080	25	1100.13.50	45	1100.20.94	62
1100.09.105	25	1100.13.91.150	33	1100.20.94.150	62
1100.09.91.105	33	1100.13.92	33	1100.20.96	64
1100.09.92	33	1100.13.94	63	1100.20.96.150	64
1100.09.94	63	1100.13.94.150	63	1100.20.98	66
1100.09.94.105	63	1100.13.96	65	1100.20.98.150	66
1100.09.96	65	1100.13.96.150	65	1100.20LF	201
1100.09.96.105	65	1100.13.98	67	1100.21	26
1100.09.98	67	1100.13.98.150	67	1100.21.125	25
1100.09.98.08	295	1100.16	26	1100.21.160	25
1100.09.98.105	67	1100.16.080	25	1100.21.205	25
1100.10.040	19	1100.16.110	25	1100.21.50	45
1100.10.060	19	1100.16.150	25	1100.21.91.205	33
1100.10.91.040	31	1100.16.50	45	1100.21.92	33
1100.10.91.060	31	1100.16.91.150	33	1100.21.94	63
1100.10.94.040	62	1100.16.92	33	1100.21.94.205	63
1100.10.94.060	62	1100.16.94	63	1100.21.96	65

# Suchhilfe

## Search help

Art.-No. Art.-No.	Seite Page	Art.-No. Art.-No.	Seite Page	Art.-No. Art.-No.	Seite Page
1100.21.96.205	65	1100.32.98.255	66	1100.48.98	67
1100.21.98	67	1100.32LF	201	1100.48.98.490	67
1100.21.98.205	67	1100.36	26	1100.50	20
1100.25	20	1100.36.260	25	1100.50.330	19
1100.25.045G	20	1100.36.305	25	1100.50.330LF	201
1100.25.065G	20	1100.36.350	25	1100.50.370	19
1100.25.080G	20	1100.36.91.350	33	1100.50.370LF	201
1100.25.125	19	1100.36.92	33	1100.50.420	19
1100.25.125LF	201	1100.36.94	63	1100.50.420LF	201
1100.25.160	19	1100.36.94.350	63	1100.50.91.420	31
1100.25.160LF	201	1100.36.96	65	1100.50.92	31
1100.25.205	19	1100.36.96.350	65	1100.50.94	62
1100.25.205LF	201	1100.36.98	67	1100.50.94.420	62
1100.25.50	45	1100.36.98.350	67	1100.50.96	64
1100.25.51	45	1100.40	20	1100.50.96.420	64
1100.25.91.205	31	1100.40.065G	20	1100.50.98	66
1100.25.92	31	1100.40.080G	20	1100.50.98.08	295
1100.25.94	62	1100.40.240	19	1100.50.98.420	66
1100.25.94.205	62	1100.40.240LF	201	1100.50LF	201
1100.25.96	64	1100.40.285	19	1100.63	20
1100.25.96.205	64	1100.40.285LF	201	1100.63.400	19
1100.25.98	66	1100.40.330	19	1100.63.400LF	201
1100.25.98.205	66	1100.40.330LF	201	1100.63.460	19
1100.25LF	201	1100.40.50	45	1100.63.460LF	201
1100.29	26	1100.40.91.330	31	1100.63.520	19
1100.29.190	25	1100.40.92	31	1100.63.520LF	201
1100.29.230	25	1100.40.94	62	1100.63.91.520	31
1100.29.275	25	1100.40.94.330	62	1100.63.92	31
1100.29.50	45	1100.40.96	64	1100.63.94	62
1100.29.91.275	33	1100.40.96.330	64	1100.63.94.520	62
1100.29.92	33	1100.40.98	66	1100.63.96	64
1100.29.94	63	1100.40.98.08	295	1100.63.96.520	64
1100.29.94.275	63	1100.40.98.330	66	1100.63.98	66
1100.29.96	65	1100.40LF	201	1100.63.98.08	295
1100.29.96.275	65	1100.42	26	1100.63.98.520	66
1100.29.98	67	1100.42.330	25	1100.63LF	201
1100.29.98.275	67	1100.42.370	25	1100.75	20
1100.32	20	1100.42.420	25	1100.75.500	19
1100.32.045G	20	1100.42.91.420	33	1100.75.560	19
1100.32.065G	20	1100.42.92	33	1100.75.630	19
1100.32.080G	20	1100.42.94	63	1100.75.98.08	295
1100.32.170	19	1100.42.94.420	63	1105.98.08	295
1100.32.170LF	201	1100.42.96	65	1106.06.98.08	295
1100.32.210	19	1100.42.96.420	65	1106.98.08	295
1100.32.210LF	201	1100.42.98	67	1107.98.08	295
1100.32.255	19	1100.42.98.420	67	1111.98.08	295
1100.32.255LF	201	1100.48	26	1113.98.22.08	295
1100.32.50	45	1100.48.370	25	1116.98.08	295
1100.32.51	45	1100.48.430	25	1116.98.25.08	295
1100.32.91.255	31	1100.48.490	25	1121.98.30.08	295
1100.32.92	31	1100.48.91.490	33	1129.98.08	295
1100.32.94	62	1100.48.92	33	1136.98.08	295
1100.32.94.255	62	1100.48.94	63	1145.12.050	238
1100.32.96	64	1100.48.94.490	63	1145.12.070	238
1100.32.96.255	64	1100.48.96	65	1145.17.060	238
1100.32.98	66	1100.48.96.490	65	1145.17.100	238

Art.-No. Art.-No.	Seite Page	Art.-No. Art.-No.	Seite Page	Art.-No. Art.-No.	Seite Page
1145.20.080	238	1160.75	21	1165.84.20.15	219
1145.20.130	238	1160.75.630	21	1165.84.25.21	219
1145.25.110	238	1165.07	213	1165.84.32.34	219
1145.25.170	238	1165.09	213	1165.84.40.34	219
1145.32.150	238	1165.10	212	1165.84.50.42	219
1145.32.210	238	1165.11	213	1165.84.63.54	219
1145.40.230	238	1165.12	212	1180.07.060	103
1145.40.280	238	1165.13	213	1180.07.075	103
1145.50.290	238	1165.16	213	1180.08.035	101
1145.50.350	238	1165.17	212	1180.08.040	101
1145.63.390	238	1165.20	212	1180.09.080	103
1145.63.480	238	1165.21	213	1180.09.100	103
1145.63.550	238	1165.25	212	1180.09.91.080	105
1160.06.025	21	1165.29	213	1180.09.91.100	105
1160.06.030	21	1165.32	212	1180.10.040	101
1160.07.065	27	1165.36	213	1180.10.060	101
1160.07.075	27	1165.40	212	1180.10.91.040	104
1160.08.030	21	1165.48	213	1180.10.91.060	104
1160.08.040	21	1165.50	212	1180.11.085	103
1160.09	27	1165.63	212	1180.11.120	103
1160.09.105	27	1165.80.07.060	218	1180.11.91.085	105
1160.10.040	21	1165.80.07.075	218	1180.11.91.120	105
1160.10.060	21	1165.80.09.080	218	1180.12.060	101
1160.11	27	1165.80.09.100	218	1180.12.060LF	204
1160.11.120	27	1165.80.10.040	217	1180.12.075	101
1160.12.050	21	1165.80.10.060	217	1180.12.075LF	204
1160.12.065	21	1165.80.11.085	218	1180.12.91.060	104
1160.12.075	21	1165.80.11.120	218	1180.12.91.075	104
1160.13	27	1165.80.12.060	217	1180.13.110	103
1160.13.145	27	1165.80.12.075	217	1180.13.140	103
1160.16	27	1165.80.13.110	218	1180.13.91.110	105
1160.16.145	27	1165.80.13.140	218	1180.13.91.140	105
1160.17	21	1165.80.16.110	218	1180.16.110	103
1160.17.105	21	1165.80.16.140	218	1180.16.140	103
1160.20	21	1165.80.17.080	217	1180.16.91.110	105
1160.20.145	21	1165.80.17.100	217	1180.16.91.140	105
1160.21	27	1165.80.20.110	217	1180.17.080	101
1160.21.190	27	1165.80.20.140	217	1180.17.080LF	204
1160.25	21	1165.80.21.160	218	1180.17.100	101
1160.25.190	21	1165.80.21.190	218	1180.17.100LF	204
1160.29	27	1165.80.25.160	217	1180.17.91.080	104
1160.29.275	27	1165.80.25.190	217	1180.17.91.100	104
1160.32	21	1165.80.29.230	218	1180.20.110	101
1160.32.255	21	1165.80.29.255	218	1180.20.110LF	204
1160.36	27	1165.80.32.210	217	1180.20.140	101
1160.36.350	27	1165.80.32.250	217	1180.20.140LF	204
1160.40	21	1165.80.36.305	218	1180.20.91.110	104
1160.40.330	21	1165.80.36.350	218	1180.20.91.140	104
1160.42	27	1165.80.40.285	217	1180.21.160	103
1160.42.420	27	1165.80.40.320	217	1180.21.190	103
1160.48	27	1165.80.48.430	218	1180.21.91.160	105
1160.48.490	27	1165.80.48.465	218	1180.21.91.190	105
1160.50	21	1165.80.50.370	217	1180.25.160	101
1160.50.420	21	1165.80.50.410	217	1180.25.160LF	204
1160.63	21	1165.80.63.460	217	1180.25.190	101
1160.63.520	21	1165.80.63.500	217	1180.25.190LF	204

# Suchhilfe

## Search help

Art.-No. Art.-No.	Seite Page	Art.-No. Art.-No.	Seite Page	Art.-No. Art.-No.	Seite Page
1180.25.91.160	104	1183.12.065	97	1300.16.150.050	44
1180.25.91.190	104	1183.12.065LF	202	1300.17.090.042	42
1180.29.230	103	1183.17	97	1300.20.130.050	42
1180.29.255	103	1183.17LF	202	1300.20.150.050	42
1180.29.91.230	105	1183.20	97	1300.21.190.070	44
1180.29.91.255	105	1183.20LF	202	1300.21.220.060	44
1180.32.210	101	1183.25	97	1300.21.220.080	44
1180.32.210LF	204	1183.25LF	202	1300.25.190.070	42
1180.32.250	101	1183.32	97	1300.29.260.070	44
1180.32.250LF	204	1183.32LF	202	1300.29.265.090	44
1180.32.91.210	104	1183.40	97	1300.29.280.060	44
1180.32.91.250	104	1183.40LF	202	1300.29.300.100	44
1180.36.305	103	1183.50	97	1300.29.320.090	44
1180.36.350	103	1183.50LF	202	1300.29.330.065	44
1180.40.285	101	1183.63	97	1300.32.220.060	42
1180.40.285LF	204	1183.63LF	202	1300.32.220.080	42
1180.40.320	101	1184.17	108	1300.40.260.070	42
1180.40.320LF	204	1184.20	108	1300.40.265.090	42
1180.42.370	103	1184.25	108	1300.40.280.060	42
1180.42.410	103	1184.32	108	1300.40.300.100	42
1180.48.430	103	1184.40	108	1300.40.320.090	42
1180.48.465	103	1184.50	108	1300.40.330.065	42
1180.50.370	101	1184.63	108	1300.42.340.115	44
1180.50.370LF	204	1184.75	108	1300.42.370.070	44
1180.50.410	101	1184.80.650	108	1300.42.400.060	44
1180.50.410LF	204	1184.85.700	108	1300.42.400.135	44
1180.63.460	101	1189.20.02LF	119	1300.42.420.140	44
1180.63.460LF	204	1189.20.090.SETAR1	117	1300.48.460.140	44
1180.63.500	101	1189.20.098.SETAR1	117	1300.48.465.060	44
1180.63.500LF	204	1189.20.103.SETAR1	117	1300.50.340.115	42
1181.07.060	99	1189.20.114.SETAR1	117	1300.50.370.070	42
1181.07.075	99	1189.20.124.SETAR1	117	1300.50.400.060	42
1181.09.080	99	1189.20.132.SETAR1	117	1300.50.400.135	42
1181.09.100	99	1189.20.139.SETAR1	117	1300.50.420.140	42
1181.11.085	99	1189.20.146.SETAR1	117	1300.63.460.140	42
1181.11.120	99	1189.25.02LF	119	1300.63.465.060	42
1181.12.060	98	1189.25.132.SETAR1	117	1301.09.090.042	44
1181.12.075	98	1189.25.139.SETAR1	117	1301.13.130.050	44
1181.13.110	99	1189.25.146.SETAR1	117	1301.13.150.050	44
1181.13.140	99	1189.25.154.SETAR1	117	1301.16.130.050	44
1181.16.110	99	1189.25.160.SETAR1	117	1301.16.150.050	44
1181.16.140	99	1189.25.168.SETAR1	117	1301.17.090.042	43
1181.17.080	98	1189.25.175.SETAR1	117	1301.20.130.050	43
1181.17.100	98	1189.25.184.SETAR1	117	1301.20.150.050	43
1181.20.110	98	1189.32.02LF	119	1301.21.190.070	44
1181.20.140	98	1189.32.175.SETAR1	117	1301.21.220.060	44
1181.21.160	99	1189.32.184.SETAR1	117	1301.21.220.080	44
1181.21.190	99	1189.32.200.SETAR1	117	1301.25.190.070	43
1181.25.160	98	1189.32.210.SETAR1	117	1301.29.260.070	44
1181.25.190	98	1189.32.227.SETAR1	117	1301.29.265.090	44
1181.29.230	99	1189.32.231.SETAR1	117	1301.29.280.060	44
1181.29.255	99	<b>13...</b>		1301.29.300.100	44
1181.32.210	98	1300.09.090.042	44	1301.29.320.090	44
1181.32.250	98	1300.13.130.050	44	1301.29.330.065	44
1183.12.050	97	1300.13.150.050	44	1301.32.220.060	43
1183.12.050LF	202	1300.16.130.050	44	1301.32.220.080	43

Art.-No. Art.-No.	Seite Page	Art.-No. Art.-No.	Seite Page	Art.-No. Art.-No.	Seite Page
1301.40.260.070	43	1310.17.2.030	34	1311.13.4.050	39
1301.40.265.090	43	1310.17.2.040	34	1311.13.4.060	39
1301.40.280.060	43	1310.17.2.050	34	1311.16.2.050	39
1301.40.300.100	43	1310.20.2.050	34	1311.16.2.060	39
1301.40.320.090	43	1310.20.2.060	34	1311.16.2.075	39
1301.40.330.065	43	1310.20.2.075	34	1311.16.2.090	39
1301.42.340.115	44	1310.20.3.050	34	1311.16.3.050	39
1301.42.370.070	44	1310.20.3.060	34	1311.16.3.060	39
1301.42.400.060	44	1310.20.3.065	34	1311.16.3.070	39
1301.42.400.135	44	1310.20.4.050	34	1311.16.4.050	39
1301.42.420.140	44	1310.20.4.060	34	1311.16.4.060	39
1301.48.460.140	44	1310.21.2.070	38	1311.16.4.070	39
1301.48.465.060	44	1310.21.2.090	38	1311.17.2.030	36
1301.50.340.115	43	1310.21.2.100	38	1311.17.2.040	36
1301.50.370.070	43	1310.21.2.115	38	1311.17.2.050	36
1301.50.400.060	43	1310.21.3.070	38	1311.20.2.050	36
1301.50.400.135	43	1310.21.3.090	38	1311.20.2.060	36
1301.50.420.140	43	1310.21.3.105	38	1311.20.2.075	36
1301.63.460.140	43	1310.21.4.070	38	1311.20.3.050	36
1301.63.465.060	43	1310.21.4.090	38	1311.20.3.060	36
1310.020.07	299	1310.21.6.060	38	1311.20.3.065	36
1310.030.07	299	1310.21.6.070	38	1311.20.4.050	36
1310.040.07	299	1310.25.2.070	34	1311.20.4.060	36
1310.050.07	299	1310.25.2.090	34	1311.21.2.070	39
1310.060.07	299	1310.25.2.100	34	1311.21.2.090	39
1310.070.07	299	1310.25.3.070	34	1311.21.2.100	39
1310.080.07	299	1310.25.3.090	34	1311.21.2.115	39
1310.09.2.030	38	1310.25.4.070	34	1311.21.3.070	39
1310.09.2.040	38	1310.25.6.060	34	1311.21.3.090	39
1310.09.2.050	38	1310.29.3.090	38	1311.21.3.105	39
1310.090.07	299	1310.32.2.115	34	1311.21.4.070	39
1310.100.07	299	1310.32.3.090	34	1311.21.4.090	39
1310.11.2.050	38	1310.32.3.105	34	1311.21.6.060	39
1310.11.2.060	38	1310.32.4.090	34	1311.21.6.070	39
1310.11.2.075	38	1310.32.6.070	34	1311.25.2.070	36
1310.11.3.050	38	1310.40.2.140	35	1311.25.2.090	36
1310.110.07	299	1310.40.4.120	35	1311.25.2.100	36
1310.120.07	299	1310.40.6.080	35	1311.25.3.070	36
1310.13.2.050	38	1310.50.4.100	35	1311.25.3.090	36
1310.13.2.060	38	1310.50.7.080	35	1311.25.4.070	36
1310.13.2.075	38	1310.63.4.150	35	1311.25.6.060	36
1310.13.3.050	38	1310.63.8.100	35	1311.29.3.090	39
1310.13.3.060	38	1310.75.6.180	35	1311.32.2.115	36
1310.13.3.065	38	1311.09.2.030	39	1311.32.3.090	36
1310.13.4.050	38	1311.09.2.040	39	1311.32.3.105	36
1310.13.4.060	38	1311.09.2.050	39	1311.32.4.090	36
1310.16.2.050	38	1311.11.2.050	39	1311.32.6.070	36
1310.16.2.060	38	1311.11.2.060	39	1311.40.2.140	37
1310.16.2.075	38	1311.11.2.075	39	1311.40.4.120	37
1310.16.2.090	38	1311.11.3.050	39	1311.40.6.080	37
1310.16.3.050	38	1311.13.2.050	39	1311.50.4.100	37
1310.16.3.060	38	1311.13.2.060	39	1311.50.7.080	37
1310.16.3.070	38	1311.13.2.075	39	1311.63.4.150	37
1310.16.4.050	38	1311.13.3.050	39	1311.63.8.100	37
1310.16.4.060	38	1311.13.3.060	39	1311.75.6.180	37
1310.16.4.070	38	1311.13.3.065	39	1370.15	82

# Suchhilfe

## Search help

Art.-No. Art.-No.	Seite Page	Art.-No. Art.-No.	Seite Page	Art.-No. Art.-No.	Seite Page
1370.15.30	82	1540.11.120	234	1540.48.430	234
1370.15.49.04	82	1540.12.050	229	1540.48.490	234
1370.15.49.45	82	1540.12.065	229	1540.50	229
1370.15.63.12	82	1540.12.080	229	1540.50.330	229
<b>14...</b>		1540.13	234	1540.50.370	229
14.582.33	251	1540.13.080	234	1540.50.420	229
14.582.34	251	1540.13.110	234	1540.63	229
14.582.35	251	1540.13.150	234	1540.63.400	229
14.582.36	251	1540.16	234	1540.63.460	229
14.582.37	251	1540.16.080	234	1540.63.520	229
14.582.38	251	1540.16.110	234	1545.07.06	241
14.582.39	251	1540.16.150	234	1545.09.08	241
14.582.93	251	1540.17	229	1545.11.07	241
14.582.94	251	1540.17.060	229	1545.11.10	241
14.582.95	251	1540.17.080	229	1545.12.06	239
14.582.96	251	1540.17.105	229	1545.12.1.06	240
14.582.97	251	1540.20	229	1545.13.07	241
14.582.98	251	1540.20.080	229	1545.13.12	241
14.582.99	251	1540.20.110	229	1545.16.11	241
14.583.03	251	1540.20.150	229	1545.16.14	241
14.583.04	251	1540.21	234	1545.17.06	239
14.583.05	251	1540.21.125	234	1545.17.1.06	240
14.583.06	251	1540.21.160	234	1545.17.1.10	240
14.583.07	251	1540.21.205	234	1545.17.10	239
14.583.08	251	1540.25	229	1545.20.08	239
14.583.09	251	1540.25.125	229	1545.20.1.08	240
1400.11	46	1540.25.160	229	1545.20.1.13	240
1400.16	46	1540.25.205	229	1545.20.13	239
1400.17	46	1540.29	234	1545.21.14	241
1400.20	46	1540.29.190	234	1545.21.18	241
1400.21	46	1540.29.230	234	1545.25.1.11	240
1400.25	46	1540.29.275	234	1545.25.1.17	240
<b>15...</b>		1540.32	229	1545.25.11	239
1520.17	230	1540.32.170	229	1545.25.17	239
1520.20	230	1540.32.210	229	1545.29.25	241
1520.20.080	230	1540.32.255	229	1545.32.1.25	240
1520.20.110	230	1540.36	234	1545.32.25	239
1520.25	230	1540.36.260	234	1545.36.33	241
1520.4.20	73	1540.36.305	234	1545.40.1.33	240
1520.4.20	224	1540.36.350	234	1545.42.38	241
1520.4.25	73	1540.4.20	73	1545.48.44	241
1520.4.25	224	1540.4.20	224	1545.50.1.38	240
1540.07.050	234	1540.4.25	73	1545.63.1.44	240
1540.07.065	234	1540.4.25	224	1545.N0375.08	242
1540.07.080	234	1540.4.32	73	1545.N0500.07	242
1540.08.035	229	1540.4.32	224	1545.N0500.12	242
1540.08.050	229	1540.40	229	1545.N0750.14	242
1540.09	234	1540.40.240	229	1545.N0750.18	242
1540.09.060	234	1540.40.285	229	1545.N1000.22	242
1540.09.080	234	1540.40.330	229	1546.07.06	245
1540.09.105	234	1540.42	234	1546.09.08	245
1540.10.040	229	1540.42.330	234	1546.11.07	245
1540.10.060	229	1540.42.370	234	1546.11.10	245
1540.11	234	1540.42.420	234	1546.12.06	243
1540.11.055	234	1540.48	234	1546.12.1.06	244
1540.11.085	234	1540.48.370	234	1546.13.07	245

Art.-No. Art.-No.	Seite Page	Art.-No. Art.-No.	Seite Page	Art.-No. Art.-No.	Seite Page
1546.13.12	245	1571.07.065	231	1571.20.065G	226
1546.16.11	245	1571.07.080	231	1571.20.080	225
1546.16.14	245	1571.08.035	225	1571.20.080G	226
1546.17.08	243	1571.08.050	225	1571.20.110	225
1546.17.1.08	244	1571.09	231	1571.20.150	225
1546.20.07	243	1571.09.060	231	1571.20.2.050	227
1546.20.1.07	244	1571.09.080	231	1571.20.2.060	227
1546.20.1.12	244	1571.09.105	231	1571.20.2.075	227
1546.20.12	243	1571.09.2.030	232	1571.20.3.050	227
1546.N0375.08	246	1571.09.2.040	232	1571.20.3.060	227
1546.N0500.07	246	1571.09.2.050	232	1571.20.3.065	227
1546.N0500.12	246	1571.10.040	225	1571.20.4.050	227
1555.07.06	241	1571.10.060	225	1571.20.4.060	227
1555.09.08	241	1571.11	231	1571.21	231
1555.11.07	241	1571.11.055	231	1571.21.125	231
1555.11.10	241	1571.11.085	231	1571.21.160	231
1555.12.06	239	1571.11.120	231	1571.21.2.070	232
1555.12.1.06	240	1571.11.2.050	232	1571.21.2.090	232
1555.13.07	241	1571.11.2.060	232	1571.21.2.100	232
1555.13.12	241	1571.11.3.050	232	1571.21.205	231
1555.16.11	241	1571.12.050	225	1571.21.3.070	232
1555.16.14	241	1571.12.065	225	1571.21.3.090	232
1555.17.06	239	1571.12.080	225	1571.21.4.070	232
1555.17.1.06	240	1571.13	231	1571.21.6.060	232
1555.17.1.10	240	1571.13.080	231	1571.25	225
1555.17.10	239	1571.13.110	231	1571.25.045G	226
1555.20.08	239	1571.13.150	231	1571.25.065G	226
1555.20.1.08	240	1571.13.2.050	232	1571.25.080G	226
1555.20.1.13	240	1571.13.2.060	232	1571.25.125	225
1555.20.13	239	1571.13.2.075	232	1571.25.160	225
1555.21.14	241	1571.13.3.050	232	1571.25.2.070	227
1555.21.18	241	1571.13.3.060	232	1571.25.2.090	227
1555.25.1.11	240	1571.13.3.065	232	1571.25.2.100	227
1555.25.1.17	240	1571.13.4.050	232	1571.25.205	225
1555.25.11	239	1571.13.4.060	232	1571.25.3.070	227
1555.25.17	239	1571.16	231	1571.25.3.090	227
1555.29.25	241	1571.16.080	231	1571.25.4.070	227
1555.32.1.25	240	1571.16.110	231	1571.25.6.060	227
1555.32.25	239	1571.16.150	231	1571.29	231
1555.36.33	241	1571.16.2.050	232	1571.29.190	231
1555.40.1.33	240	1571.16.2.060	232	1571.29.230	231
1555.42.38	241	1571.16.2.075	232	1571.29.275	231
1555.48.44	241	1571.16.3.050	232	1571.29.3.090	232
1555.50.1.38	240	1571.16.3.060	232	1571.32	225
1555.63.1.44	240	1571.16.3.065	232	1571.32.045G	226
1555.N0375.08	242	1571.16.4.050	232	1571.32.065G	226
1555.N0500.07	242	1571.16.4.060	232	1571.32.080G	226
1555.N0500.12	242	1571.17	225	1571.32.170	225
1555.N0750.14	242	1571.17.060	225	1571.32.2.115	227
1555.N0750.18	242	1571.17.080	225	1571.32.210	225
1555.N1000.22	242	1571.17.105	225	1571.32.255	225
1570.17	230	1571.17.2.030	227	1571.32.3.090	227
1570.20	230	1571.17.2.040	227	1571.32.3.105	227
1570.25	230	1571.17.2.050	227	1571.32.4.090	227
1570.32	230	1571.20	225	1571.32.6.070	227
1571.07.050	231	1571.20.045G	226	1571.36	231

Art.-No. Art.-No.	Seite Page	Art.-No. Art.-No.	Seite Page	Art.-No. Art.-No.	Seite Page
1571.36.260	231	1572.16.150	233	1576.13.12	245
1571.36.305	231	1572.17	228	1576.16.11	245
1571.36.350	231	1572.17.060	228	1576.16.14	245
1571.4.20	73	1572.17.080	228	1576.17.08	243
1571.4.20	224	1572.17.105	228	1576.17.1.08	244
1571.4.25	73	1572.20	228	1576.20.07	243
1571.4.25	224	1572.20.080	228	1576.20.1.07	244
1571.4.32	73	1572.20.110	228	1576.20.1.12	244
1571.4.32	224	1572.20.150	228	1576.20.12	243
1571.40	225	1572.21	233	1576.N0375.08	246
1571.40.065G	226	1572.21.125	233	1576.N0500.07	246
1571.40.080G	226	1572.21.160	233	1576.N0500.12	246
1571.40.240	225	1572.21.205	233	<b>16...</b>	
1571.40.285	225	1572.25	228	1600.17	252
1571.40.330	225	1572.25.125	228	1600.20	252
1571.42	231	1572.25.160	228	1600.25	252
1571.42.330	231	1572.25.205	228	1600.32	252
1571.42.370	231	1572.29	233	1600.40	252
1571.42.420	231	1572.29.190	233	1600.50	252
1571.48	231	1572.29.230	233	1600.63	252
1571.48.370	231	1572.29.275	233	1620.17	252
1571.48.430	231	1572.32	228	1620.20	252
1571.48.490	231	1572.32.170	228	1620.25	252
1571.50	225	1572.32.210	228	1620.32	252
1571.50.330	225	1572.32.255	228	1620.40	252
1571.50.370	225	1572.36	233	1620.50	252
1571.50.420	225	1572.36.260	233	1620.63	252
1571.63	225	1572.36.305	233	<b>17...</b>	
1571.63.400	225	1572.36.350	233	1700.07.10	210
1571.63.460	225	1572.40	228	1700.09.14	210
1571.63.520	225	1572.40.240	228	1700.11.14	210
1572.07.050	233	1572.40.285	228	1700.11.17	210
1572.07.065	233	1572.40.330	228	1700.12.1/4	208
1572.07.080	233	1572.42	233	1700.12.10	208
1572.08.035	228	1572.42.330	233	1700.13.19	210
1572.08.050	228	1572.42.370	233	1700.16.17	210
1572.09	233	1572.42.420	233	1700.16.21	210
1572.09.060	233	1572.48	233	1700.17.14	208
1572.09.080	233	1572.48.370	233	1700.20.1/2	208
1572.09.105	233	1572.48.430	233	1700.20.17	208
1572.10.040	228	1572.48.490	233	1700.20.19	208
1572.10.060	228	1572.50	228	1700.20.21	208
1572.11	233	1572.50.330	228	1700.20.3/8	208
1572.11.055	233	1572.50.370	228	1700.21.27	210
1572.11.085	233	1572.50.420	228	1700.25.21	208
1572.11.120	233	1572.63	228	1700.25.27	208
1572.12.050	228	1572.63.400	228	1700.25.3/4	208
1572.12.065	228	1572.63.460	228	1700.29.36	210
1572.12.080	228	1572.63.520	228	1700.32.1	208
1572.13	233	1576.07.06	245	1700.32.27	208
1572.13.080	233	1576.09.08	245	1700.36.45	210
1572.13.110	233	1576.11.07	245	1700.40.11/4	208
1572.13.150	233	1576.11.10	245	1700.40.36	208
1572.16	233	1576.12.06	243	1700.42.45	210
1572.16.080	233	1576.12.1.06	244	1700.48.56	210
1572.16.110	233	1576.13.07	245	1700.50.45	208

Art.-No. Art.-No.	Seite Page	Art.-No. Art.-No.	Seite Page	Art.-No. Art.-No.	Seite Page
1700.63.2	208	1710.80.25.160.1	214	1800.11.21	56
1700.63.56	208	1710.80.25.160.2	215	1800.11.25	55
1710.60.07.10	210	1710.80.25.190.1	214	1800.11.29	56
1710.60.09.14	210	1710.80.25.190.2	215	1800.11.32	55
1710.60.11.14	210	1710.80.29.230.1	216	1800.11.40	55
1710.60.11.17	210	1710.80.29.255.1	216	1800.12.03.065	50
1710.60.12.1/4	209	1710.80.32.210.1	214	1800.12.03.080	50
1710.60.12.10	209	1710.80.32.210.2	215	1800.12.13.065	51
1710.60.13.19	210	1710.80.32.250.1	214	1800.12.13.080	51
1710.60.16.17	210	1710.80.32.250.2	215	1800.13.03.150	52
1710.60.16.21	210	1710.80.36.305.1	216	1800.13.13.150	53
1710.60.17.14	209	1710.80.36.350.1	216	1800.16.03.150	52
1710.60.20.1/2	209	1710.80.40.285.1	214	1800.16.13.150	53
1710.60.20.17	209	1710.80.40.285.2	215	1800.17.03.105	50
1710.60.20.19	209	1710.80.40.320.1	214	1800.17.13.105	51
1710.60.20.21	209	1710.80.40.320.2	215	1800.20.03.150	50
1710.60.20.3/8	209	1710.80.42.370.1	216	1800.20.13.150	51
1710.60.21.27	210	1710.80.42.410.1	216	1800.21.03.205	52
1710.60.25.21	209	1710.80.48.430.1	216	1800.21.13.205	53
1710.60.25.27	209	1710.80.48.465.1	216	1800.25.03.205	50
1710.60.25.3/4	209	1710.80.50.370.1	214	1800.25.13.205	51
1710.60.29.36	210	1710.80.50.410.1	214	1800.29.03.275	52
1710.60.32.1	209	1710.80.63.460.1	214	1800.29.13.275	53
1710.60.32.27	209	1710.80.63.460.2	215	1800.32.03.255	50
1710.60.36.45	210	1710.80.63.500.1	214	1800.32.13.255	51
1710.60.40.11/4	209	1710.80.63.500.2	215	1800.36.03.350	52
1710.60.40.36	209	<b>18...</b>		1800.36.13.350	53
1710.60.42.45	210	1800.07.03.065	52	1800.40.03.330	50
1710.60.48.56	210	1800.07.03.080	52	1800.40.13.330	51
1710.60.50.45	209	1800.07.13.065	53	1800.42.03.410	52
1710.60.63.2	209	1800.07.13.080	53	1800.42.13.410	53
1710.60.63.56	209	1800.09.03.105	52	1800.48.03.490	52
1710.80.07.060.1	216	1800.09.13.105	53	1800.48.13.490	53
1710.80.09.080.1	216	1800.10.03.040	50	1800.50.03.410	50
1710.80.09.100.1	216	1800.10.03.060	50	1800.50.13.410	51
1710.80.11.085.1	216	1800.10.09	56	1800.63.03.520	50
1710.80.11.120.1	216	1800.10.11	56	1800.63.13.520	51
1710.80.12.060.1	214	1800.10.13	56	1800.75.03.630	50
1710.80.12.060.2	215	1800.10.13.040	51	1800.75.13.630	51
1710.80.13.110.1	216	1800.10.13.060	51	1801.09	86
1710.80.13.140.1	216	1800.10.16	56	1801.10.09	58
1710.80.16.110.1	216	1800.10.17	55	1801.10.11	58
1710.80.16.140.1	216	1800.10.20	55	1801.10.13	58
1710.80.17.080.1	214	1800.10.21	56	1801.10.16	58
1710.80.17.080.2	215	1800.10.25	55	1801.10.17	57
1710.80.17.100.1	214	1800.10.29	56	1801.10.20	57
1710.80.17.100.2	215	1800.10.32	55	1801.10.21	58
1710.80.20.110.1	214	1800.10.40	55	1801.10.25	57
1710.80.20.110.2	214	1800.11.03.120	52	1801.10.29	58
1710.80.20.110.3	215	1800.11.09	56	1801.10.32	57
1710.80.20.110.4	215	1800.11.11	56	1801.10.40	57
1710.80.20.140.1	214	1800.11.13	56	1801.11	86
1710.80.20.140.2	214	1800.11.13.120	53	1801.11.09	58
1710.80.20.140.4	215	1800.11.16	56	1801.11.11	58
1710.80.21.160.1	216	1800.11.17	55	1801.11.13	58
1710.80.21.190.1	216	1800.11.20	55	1801.11.16	58

Art.-No. Art.-No.	Seite Page	Art.-No. Art.-No.	Seite Page	Art.-No. Art.-No.	Seite Page
1801.11.17	57	181NPT.21.26	158	1852.25.19	87
1801.11.20	57	181NPT.21.27	158	1852.25.20	87
1801.11.21	58	1820.02	54	1852.29.20	87
1801.11.25	57	1820.11.26	157	1852.29.23	87
1801.11.29	58	1820.16.26	157	1852.29.25	87
1801.11.32	57	1821.02	54	1852.32.23	87
1801.11.40	57	1821.26	157	1852.32.25	87
1801.13	86	1821.27	157	1852.36.26	87
1801.16	86	1825.02	54	1852.36.30	87
1801.17	86	1825.21.26	157	1852.36.33	87
1801.20.10	86	1825.21.27	157	1852.36.35	87
1801.20.12	86	1829.02	54	1852.40.26	87
1801.20.14	86	1829.26	157	1852.40.30	87
1801.21	86	1829.27	157	1852.40.33	87
1801.25	86	183/4G.21.26	158	1852.40.35	87
1801.29	86	183/4G.21.27	158	1852.42.35	87
1801.32	86	183/4NPT.11.26	158	1852.42.38	87
1803.07	85	183/4NPT.16.26	158	1852.42.40	87
1803.09	85	183/4NPT.21.26	158	1863.48.26	157
1803.11	85	183/8G.09.26	158	1863.48.27	157
1803.12	85	183/8NPT.09.26	158	<b>19...</b>	
1803.13	85	1832.02	54	1908.20.235.05	132
1803.16	85	1832.29.26	157	1908.25.265.05	132
1803.17	85	1836.02	54	1908.32.343.05	132
1803.20	85	1836.26	157	1908.88.03.012	130
1803.21	85	1836.27	157	1908.88.03.022	130
1803.25	85	1840.02	54	1908.88.03.83.103	131
1803.29	85	1840.29.27	157	1908.88.03.83.113	131
1803.32	85	1848.26	158	1908.88.08.010	130
1803.36	85	1848.27	158	1908.88.08.011	130
1803.40	85	1848.48.26	157	1908.88.08.020	130
1803.42	85	1848.48.27	157	1908.88.08.021	130
1803.48.48	85	1850.36.26	157	1908.88.08.83.101	131
1807.02	54	1850.36.27	157	1908.88.08.83.102	131
1809.02	54	1852.07.05	87	1908.88.08.83.111	131
1809.26	157	1852.09.07	87	1908.88.08.83.112	131
181/2G.11.26	158	1852.11.07	87	1988.88.001	132
181/2G.16.26	158	1852.11.09	87	<b>20...</b>	
181/2NPT.11.26	158	1852.12.05	87	2000-00	308
181/2NPT.16.26	158	1852.13.09	87	2000-80	309
1811.02	54	1852.13.11	87	2000-90	309
1811.26	157	1852.13.13	87	<b>21...</b>	
1811/2G.36.26	158	1852.16.07	87	2111.00.08	294
1811/2NPT.36.26	158	1852.16.13	87	2111.98.08	295
1811/2NPT.36.27	158	1852.16.15	87	<b>24...</b>	
1811/4G.29.27	158	1852.20.07	87	2410.17	261
1811/4NPT.29.26	158	1852.20.09	87	2410.20	261
1811/4NPT.29.27	158	1852.20.11	87	2410.25	261
1812.02	54	1852.20.13	87	2410.32	261
1813.02	54	1852.20.15	87	2410.40	261
1813.26	157	1852.21.15	87	2410.50	261
1816.02	54	1852.21.17	87	2445.12	256
1816.26	157	1852.21.19	87	2450.07.32	259
1817.02	54	1852.21.20	87	2450.07.34	257
1817.09.26	157	1852.25.15	87	2450.11.32	259
181G.29.26	158	1852.25.17	87	2450.11.34	257

Art.-No. Art.-No.	Seite Page	Art.-No. Art.-No.	Seite Page	Art.-No. Art.-No.	Seite Page	
2450.12.32	259	3455.63.32	282	3500.42.50	277	1
2450.12.34	257	3455.63.40	282	3500.48.40	277	—
2450.12.36	260	3455.63.50	282	3500.48.50	277	
2450.17.32	259	3463.48	284	3500.50.29	276	2
2450.17.34	257	<b>35...</b>		3500.50.32	272	—
2450.17.36	260	3500.07.06	277	3500.50.40	272	
2450.20.32	259	3500.07.08	277	3500.63.36	276	
2450.20.34	257	3500.07.10	277	3500.63.40	272	3
2450.20.36	260	3500.08.06	272	3500.63.50	272	—
2455.12	256	3500.09.06	277	3500.75.50	272	
2460.12.97.34	258	3500.09.08	277	3500.75.63	272	
<b>34...</b>		3500.09.10	277	3509.07	273	4
3409.07	282	3500.09.12	277	351/2G.09	280	—
3411.07	282	3500.10.06	272	351/2NPT.09	281	
3411.09	282	3500.10.08	272	3511.07	273	
3413.09	282	3500.11.06	277	3511.09	273	5
3413.11	282	3500.11.08	277	3511/4G.29	280	—
3416.09	282	3500.11.10	277	3513.07	273	
3416.11	282	3500.11.12	277	3513.09	273	
3416.13	282	3500.11.17	277	3513.11	273	6
3417.09	284	3500.12.08	272	35133/8G	280	—
3420.11	284	3500.12.10	272	3516.09	273	
3421.13	282	3500.13.12	277	3516.11	273	
3421.16	282	3500.13.17	277	3516.13	273	7
3425.16	284	3500.16.12	277	351G.21	280	—
3429.21	282	3500.16.17	277	351NPT.16	281	
3436.29	282	3500.16.20	277	3521.11	273	
3440.29	284	3500.17.07	276	3521.13	273	8
3450.36	284	3500.17.10	272	3521.16	273	—
3455.09.12	285	3500.17.12	272	3529.13	273	
3455.11.17	285	3500.20.07	276	3529.16	273	
3455.13.17	285	3500.20.09	276	3529.21	273	9
3455.13.20	285	3500.20.11	276	352G.36	280	—
3455.16.20	285	3500.20.12	272	352G.42	280	
3455.17.12	282	3500.20.17	272	353/4G.09	280	
3455.20.12	282	3500.21.17	277	353/4G.11	280	10
3455.20.17	282	3500.21.20	277	353/4G.16	280	—
3455.21.25	285	3500.21.25	277	353/4NPT.11	281	
3455.25.12	282	3500.25.09	276	353/4NPT.13	281	
3455.25.17	282	3500.25.11	276	353/8G.07	280	11
3455.25.20	282	3500.25.13	276	3536.21	273	—
3455.29.32	285	3500.25.16	276	3536.29	273	
3455.32.12	282	3500.25.17	272	3542.29	273	
3455.32.17	282	3500.25.20	272	3542.36	273	12
3455.32.20	282	3500.29.25	277	3545.11.17	279	—
3455.32.25	282	3500.29.32	277	3545.16.20	279	
3455.36.40	285	3500.32.20	272	3545.17.12	273	
3455.40.17	282	3500.32.21	276	3545.20.12	273	
3455.40.20	282	3500.32.25	272	3545.20.17	273	13
3455.40.25	282	3500.36.32	277	3545.21.20	279	—
3455.40.32	282	3500.36.40	277	3545.21.25	279	
3455.50.20	282	3500.40.25	272	3545.25.17	273	
3455.50.25	282	3500.40.29	276	3545.25.20	273	14
3455.50.32	282	3500.40.32	272	3545.29.25	279	—
3455.50.40	282	3500.42.32	277	3545.29.32	279	
3455.63.25	282	3500.42.40	277	3545.32.20	273	

Art.-No. Art.-No.	Seite Page
3545.32.25	273
3545.36.40	279
3545.40.25	273
3545.40.32	273
3545.50.32	273
3545.50.40	273
3545.63.40	273
3545.63.50	273
3548.48.36	273
<b>36...</b>	
3600.06.08	274
3600.06.10	274
3600.07.12	278
3600.07.17	278
3600.08.10	274
3600.08.12	274
3600.09.17	278
3600.09.20	278
3600.10.07	276
3600.10.09	276
3600.10.12	274
3600.10.17	274
3600.11.20	278
3600.11.25	278
3600.12.09	276
3600.12.17	274
3600.12.20	274
3600.13.20	278
3600.13.25	278
3600.16.25	278
3600.16.32	278
3600.17.11	276
3600.17.20	274
3600.20.13	276
3600.20.16	276
3600.20.25	274
3600.21.32	278
3600.21.40	278
3600.25.21	276
3600.25.32	274
3600.29.40	278
3600.29.50	278
3600.32.29	276
3600.32.40	274
3600.36.50	278
3600.36.63	278
3600.40.36	276
3600.40.50	274
3600.42.63	278
3600.42.75	278
3600.48.63	278
3600.48.75	278
3600.50.42	276
3600.50.48	276
3600.50.63	274
3600.63.75	274

Art.-No. Art.-No.	Seite Page
3607.09.08	275
3609.11.08	275
3609.13.08	275
361/2G.11.08	280
361/2G.13.08	280
361/2G.16.08	280
361/2NPT.11	281
361/2NPT.13	281
361/2NPT.16	281
3611.13.08	275
3611.16.08	275
3611.21.08	275
3611/2G.36.08	280
3613.16.08	275
3613.21.08	275
3616.21.08	275
3616.29.08	275
36161/2G.08	280
361G.29.08	280
3621.29.08	275
36213/4G.08	280
3629.36.08	275
363/4G.21.08	280
363/4NPT.21	281
363/8G.11.08	280
3636.42.08	275
3636.48.08	280
3636.48.48.08	275
3642.48.08	280
3645.07.12	279
3645.09.17	279
3645.11.20	279
3645.12.17	274
3645.13.20	279
3645.16.25	279
3645.17.20	274
3645.20.25	274
3645.21.32	279
3645.25.32	274
3645.29.40	279
3645.32.40	274
3645.40.50	274
3645.50.63	274
365/8G.16.08	280
367/8G.29.08	280
<b>37...</b>	
3707.09	283
3709.11	283
3711.13	283
3712.09	284
3713.16	283
3716.21	283
3720.13	284
3720.16	284
3721.29	283
3725.21	284

Art.-No. Art.-No.	Seite Page
3729.36	283
3732.29	284
3736.42	283
3742.48	283
3750.42	284
3755.07.12	285
3755.07.17	285
3755.09.17	285
3755.09.20	285
3755.11.20	285
3755.12.17	283
3755.13.25	285
3755.16.25	285
3755.17.20	283
3755.20.25	283
3755.21.32	285
3755.25.32	283
3755.29.40	285
3755.32.40	283
3755.40.50	283
3755.42.50	285
3755.48.63	285
3755.50.63	283
<b>48...</b>	
4800.24	300
4800.36	300
4801.00.01	122
4801.00.02	122
4801.00.03	122
4801.00.04	122
4801.01	124
4801.01USA	124
4801.02EU	124
4801.090.01	123
4801.098.01	123
4801.103.01	123
4801.114.01	123
4801.124.01	123
4801.132.01	123
4801.139.146.01	123
4801.154.01	123
4801.160.01	123
4801.168.01	123
4801.175.01	123
4801.184.01	123
4801.20.01	123
4801.200.01	123
4801.210.01	123
4801.227.01	123
4801.231.01	123
4801.25.01	123
4801.250.01	123
4801.32.01	123
4801.40.01	123
4801.EU	124
4801.USA	124

Art.-No. Art.-No.	Seite Page	Art.-No. Art.-No.	Seite Page	Art.-No. Art.-No.	Seite Page
<b>50...</b>		5215.11.95	249	5612	79
5000.17.50	261	5215.12	78	5613	79
5000.20.50	261	5215.13	78	5616	79
5000.25.50	261	5215.13.105	249	5617	79
5000.32.50	261	5215.13.13	249	5620	79
5030.013.010	220	5215.13.95	249	5621	79
5030.013.014	220	5215.16	78	5625	79
5030.013.017	220	5215.16.105	249	5629	79
5030.013.021	220	5215.16.13	249	5632	79
5030.013.027	220	5215.16.155	249	5636	79
5030.013.036	220	5215.16.95	249	5640	79
5030.013.045	220	5215.17	78	5650	79
5030.013.056	220	5215.17.40.95	249	<b>57...</b>	
5031.034.007	220	5215.17.95	249	5717	80
5031.034.009	220	5215.20	78	5720	80
5031.034.011	220	5215.20.105	249	5725	80
5031.034.013	220	5215.20.13	249	5732	80
5031.034.016	220	5215.20.40.105	249	<b>68...</b>	
5031.034.021	220	5215.20.40.13	249	6850.40.03	305
5031.034.029	220	5215.21	78	6850.40.04	305
5031.034.036	220	5215.25	78	6850.40.05	305
5031.034.048	220	5215.25.155	249	6850.40.06	305
<b>52...</b>		5215.25.40.155	249	6850.40.10	305
5200.07	77	5215.29	78	6850.40.12	305
5200.09	77	5215.32	78	6850.40.16	305
5200.11	77	5215.40	78	6850.40.22	305
5200.12	76	<b>55...</b>		6850.40.24	305
5200.13	77	5500.40.17	250	6850.40.30	305
5200.16	77	5500.40.20	250	6850.40.35	305
5200.17	76	5500.40.25	250	6850.40.45	305
5200.20	76	5500.40.32	250	6850.40.50	305
5200.21	77	5500.40.40	250	6850.40.70	305
5200.25	76	5500.40.50	250	6875.40.03	303
5200.29	77	5516.10	81	6875.40.05	303
5200.32	76	5516.12	81	6875.40.05.10	304
5200.40	76	5516.13	81	6875.40.08	303
5210.07	77	5517	81	6875.40.10	303
5210.09	77	5520	81	6875.40.10.10	304
5210.11	77	5521.10	81	6875.40.15	303
5210.12	76	5525	81	6875.40.18.06	304
5210.13	77	5529.10	81	6875.40.20	303
5210.16	77	5532	81	6875.40.24	303
5210.17	76	5536.10	81	6875.40.30.06	304
5210.20	76	5540	81	6875.40.36	303
5210.21	77	5540.11	250	6875.40.50	303
5210.25	76	5540.16	250	6875.70.03	303
5210.29	77	5540.21	250	6875.70.05	303
5210.32	76	5540.29	250	6875.70.08	303
5210.40	76	5540.36	250	6875.70.10	303
5215.07	78	5540.48.48	250	6875.70.15	303
5215.09	78	5550	81	6875.70.20	303
5215.09.65	249	5563	81	6875.70.24	303
5215.09.95	249	<b>56...</b>		6875.70.36	303
5215.11	78	5607	79	6875.70.50	303
5215.11.105	249	5609	79	6875.80.05	304
5215.11.65	249	5611	79	6875.80.08	304

Art.-No. Art.-No.	Seite Page	Art.-No. Art.-No.	Seite Page	Art.-No. Art.-No.	Seite Page
6875.80.10	304	8000.75	262	8036.96	265
6875.80.12	304	8007	262	8040.85	111
6875.80.16	304	8007.85	111	8040.85LF	205
6875.80.20	304	8007.96	265	8040.96	265
6875.80.25	304	8008.85	111	8040.98	266
6875.80.35	304	8008.96	265	8042	262
6875.80.45	304	8008.98	266	8042.85	111
6879.40.05	306	8009	262	8048	263
6879.40.08	306	8009.85	111	8048.48	262
6879.40.10	306	8009.96	265	8048.85	111
6879.40.13	306	801/2G	263	805/8G	263
6879.40.16	306	8010.85	111	8050	263
6879.40.19	306	8010.96	265	8050.85	111
6879.40.25	306	8010.98	266	8050.85LF	205
6879.40.29	306	8011	262	8050.96	265
6879.40.32	306	8011.85	111	8050.98	266
6879.40.38	306	8011.96	265	8051	263
6879.40.50	306	8011/2G	263	8063.85	111
6879.80.08	307	8011/4G	263	8063.85LF	205
6879.80.13	307	8012.85	111	8063.96	265
6879.80.16	307	8012.85LF	205	8063.98	266
6879.80.19	307	8012.96	265	8075.85	111
6879.80.25	307	8012.98	266	8080.85	111
6879.80.29	307	8013	262	8085.85	111
6879.80.32	307	8013.85	111	<b>82...</b>	
6879.80.38	307	8013.96	265	8200.17.45	271
6879.80.50	307	8016	262	8200.20.45	271
<b>80...</b>		8016.85	111	8200.25.45	271
8000.06	262	8016.96	265	8200.32.45	271
8000.06.1	262	8017.85	111	8200.40.45	271
8000.08	262	8017.85LF	205	8200.50.45	271
8000.08.1	262	8017.96	265	8200.63.45	271
8000.080	262	8017.98	266	8207	268
8000.085	262	801G	263	8207.40	268
8000.095	262	8020.85	111	8209	268
8000.10	262	8020.85LF	205	8209.40	268
8000.10.1	262	8020.96	265	8211	268
8000.100	262	8020.98	266	8211.40	268
8000.105	262	8021	262	8212	267
8000.115	262	8021.85	111	8212.40	267
8000.12	262	8021.96	265	8213	268
8000.12LF	205	8025.85	111	8213.40	268
8000.17	262	8025.85LF	205	8216	268
8000.17LF	205	8025.96	265	8216.40	268
8000.20	262	8025.98	266	8217	267
8000.20LF	205	8029	262	8217.40	267
8000.25	262	8029.85	111	8220	267
8000.25LF	205	8029.96	265	8220.40	267
8000.32	262	803/4G	263	8221	268
8000.32LF	205	803/8G	263	8221.40	268
8000.40	262	8032.85	111	8225	267
8000.40LF	205	8032.85LF	205	8225.40	267
8000.50	262	8032.96	265	8229	268
8000.50LF	205	8032.98	266	8229.40	268
8000.63	262	8036	262	8232	267
8000.63LF	205	8036.85	111	8232.40	267

Art.-No. Art.-No.	Seite Page	Art.-No. Art.-No.	Seite Page	Art.-No. Art.-No.	Seite Page
8236	268	8300.20	263	8716.08	288
8236.40	268	8300.20.1	264	8716.11.08	288
8240	267	8300.21	263	8717.08	286
8240.40	267	8300.25	263	8717.11.08	286
8242	268	8300.25.1	264	8717.96.08	290
8242.40	268	8300.29	263	8717.96.08.70	289
8245.07	270	8300.32	263	8717.96.11.08	290
8245.09	270	8300.32.1	264	8717.96.11.08.70	289
8245.11	270	8300.40	263	8720.08	286
8245.12	269	8300.40.1	264	8720.11.08	286
8245.13	270	8300.50.1	264	8720.96.08	290
8245.16	270	8300.63.1	264	8720.96.08.70	289
8245.17	269	8324.12	260	8720.96.11.08	290
8245.20	269	8324.17	260	8720.96.11.08.70	289
8245.21	270	8324.20	260	8721.08	288
8245.25	269	<b>87...</b>		8721.11.08	288
8245.29	270	8706.08	286	8725.08	286
8245.32	269	8706.11.08	286	8725.11.08	286
8245.36	270	8707.08	288	8725.96.08	290
8245.40	269	8707.11.08	288	8725.96.08.70	289
8245.42	270	8708.08	286	8725.96.11.08	290
8245.48	270	8708.11.08	286	8725.96.11.08.70	289
8245.50	269	8709.08	288	8729.08	288
8245.63	269	8709.11.08	288	8729.11.08	288
8248.48	268	8710.07	162	8732.08	286
8248.48.40	268	8710.08	286	8732.11.08	286
8250	267	8710.09	162	8732.96.08	290
8250.40	267	8710.11	162	8732.96.08.70	289
8255.07	270	8710.11.08	286	8732.96.11.08	290
8255.09	270	8710.12	162	8732.96.11.08.70	289
8255.11	270	8710.13	162	8736.08	288
8255.12	269	8710.16	162	8736.11.08	288
8255.13	270	8710.17	162	8740.08	286
8255.16	270	8710.20	162	8740.11.08	286
8255.17	269	8710.21	162	8740.96.08	290
8255.20	269	8710.25	162	8740.96.08.70	289
8255.21	270	8710.29	162	8740.96.11.08	290
8255.25	269	8710.32	162	8740.96.11.08.70	289
8255.29	270	8710.36	162	8742.08	288
8255.32	269	8710.40	162	8745.12	287
8255.36	270	8710.50	162	8745.12.08	287
8255.40	269	8710.63	162	8745.17	287
8255.42	270	8710.96.08	290	8745.17.08	287
8255.48	270	8710.96.08.70	289	8745.20	287
8255.50	269	8710.96.11.08	290	8745.20.08	287
8255.63	269	8710.96.11.08.70	289	8745.25	287
<b>83...</b>		8711.08	288	8745.25.08	287
8300.07	263	8711.11.08	288	8745.32	287
8300.09	263	8712.08	286	8745.32.08	287
8300.11	263	8712.11.08	286	8745.40	287
8300.12	263	8712.96.08	290	8745.40.08	287
8300.12.1	264	8712.96.08.70	289	8745.50	287
8300.13	263	8712.96.11.08	290	8745.50.08	287
8300.16	263	8712.96.11.08.70	289	8745.63	287
8300.17	263	8713.08	288	8745.63.08	287
8300.17.1	264	8713.11.08	288	8748.08	288

Art.-No. Art.-No.	Seite Page
8748.48.08	288
8750.08	286
8750.11.08	286
8750.96.08	290
8750.96.08.70	289
8750.96.11.08	290
8750.96.11.08.70	289
8763.08	286
8763.11.08	286
8763.96.08	290
8763.96.08.70	289
8763.96.11.08	290
8763.96.11.08.70	289
8775.08	286
8775.11.08	286
8775.96.08	290
8775.96.08.70	289
8775.96.11.08	290
8775.96.11.08.70	289
<b>88...</b>	
8807	291
8809	291
8811	291
8813	291
8816	291
8821	291
8829	291
8836	291
8841.07	195
8841.09	195
8841.11	195
8841.12	195
8841.13	195
8841.16	195
8841.17	195
8841.20	195
8841.21	195
8841.25	195
8841.29	195
8841.32	195
8841.36	195
8841.40	195
8841.42	195
8841.48	195
8841.50	195
8841.63	195
8842	291
8845.12	291
8845.17	291
8845.20	291
8845.25	291
8845.32	291
8845.40	291
8845.50	291
8845.63	291
8855.12	291

Art.-No. Art.-No.	Seite Page
8855.17	291
8855.20	291
8855.25	291
8855.32	291
8855.40	291
8855.50	291
8855.63	291
<b>B...</b>	
B 107	84
B 107.00.03	298
B 109	84
B 109.00.03	298
B 111	84
B 111.00.03	298
B 112	83
B 113	84
B 113.00.03	298
B 116	84
B 116.00.03	298
B 117	83
B 120.10	83
B 120.12	83
B 120.14	83
B 121	84
B 121.00.03	298
B 125	83
B 129	84
B 129.00.03	298
B 132	83
B 136	84
B 136.00.03	298
B 140	83
B 142	84
B 142.00.03	298
B 148.00.03	298
B 148.48	84
B 150	83
B 163	83
B 209	84
B 211	84
B 212	83
B 213	84
B 216	84
B 217	83
B 220.10	83
B 220.12	83
B 220.14	83
B 221	84
B 225	83
B 229	84
B 232	83
B 236	84
B 240	83
B 242	84
B 248.48	84
B 250	83

Art.-No. Art.-No.	Seite Page
B 263	83
<b>EX...</b>	
EX1000.07.065	165
EX1000.07.080	165
EX1000.08.035	163
EX1000.08.050	163
EX1000.09.060	165
EX1000.09.080	165
EX1000.10.040	163
EX1000.10.060	163
EX1000.11.055	165
EX1000.11.085	165
EX1000.12.065	163
EX1000.12.080	163
EX1000.13.080	165
EX1000.13.110	165
EX1000.16.080	165
EX1000.16.110	165
EX1000.17.060	163
EX1000.17.080	163
EX1000.20.080	163
EX1000.20.110	163
EX1000.21.125	165
EX1000.21.160	165
EX1000.25.125	163
EX1000.25.160	163
EX1000.29.190	165
EX1000.29.230	165
EX1000.32.170	163
EX1000.32.210	163
EX1000.36.260	165
EX1000.36.305	165
EX1000.40.240	163
EX1000.40.285	163
EX1080.07.060	175
EX1080.07.075	175
EX1080.08.035	174
EX1080.08.040	174
EX1080.09.080	175
EX1080.09.100	175
EX1080.10.040	174
EX1080.10.060	174
EX1080.11.085	175
EX1080.11.120	175
EX1080.12.060	174
EX1080.12.075	174
EX1080.13.110	175
EX1080.13.140	175
EX1080.16.110	175
EX1080.16.140	175
EX1080.17.080	174
EX1080.17.100	174
EX1080.20.110	174
EX1080.20.140	174
EX1080.21.160	175
EX1080.21.190	175

Art.-No. Art.-No.	Seite Page	Art.-No. Art.-No.	Seite Page	Art.-No. Art.-No.	Seite Page
EX1080.25.160	174	EX1100.32.170	164	EX1310.120.07	299
EX1080.25.190	174	EX1100.32.210	164	EX1310.13.2.050	168
EX1080.29.230	175	EX1100.36.260	166	EX1310.13.3.040	168
EX1080.29.255	175	EX1100.36.305	166	EX1310.150.07	180
EX1080.32.210	174	EX1100.40.240	164	EX1310.150.07	299
EX1080.36.305	175	EX1100.40.285	164	EX1310.16.2.060	168
EX1080.40.285	174	EX1126.1/2NPT.110	161	EX1310.16.3.060	168
EX1081.07.060	173	EX1126.1/2NPT.140	161	EX1310.16.6.030	168
EX1081.07.075	173	EX1126.11/2NPT.360 161		EX1310.16.6.040	168
EX1081.09.080	173	EX1126.11/4NPT.320 161		EX1310.17.2.030	167
EX1081.09.100	173	EX1126.17.070	159	EX1310.17.4.015	167
EX1081.11.085	173	EX1126.17.100	159	EX1310.180.07	180
EX1081.11.120	173	EX1126.1NPT.230	161	EX1310.180.07	299
EX1081.12.060	173	EX1126.1NPT.260	161	EX1310.20.2.050	167
EX1081.12.075	173	EX1126.20.110	159	EX1310.20.2.075	167
EX1081.13.110	173	EX1126.20.140	159	EX1310.20.3.060	167
EX1081.13.140	173	EX1126.25.150	159	EX1310.20.4.050	167
EX1081.16.110	173	EX1126.25.180	159	EX1310.20.6.030	167
EX1081.16.140	173	EX1126.2NPT.440	161	EX1310.21.3.090	168
EX1081.17.080	173	EX1126.3/4NPT.150	161	EX1310.21.4.070	168
EX1081.17.100	173	EX1126.3/4NPT.180	161	EX1310.25.2.100	167
EX1081.20.110	173	EX1126.3/8NPT.070	161	EX1310.25.3.070	167
EX1081.20.140	173	EX1126.3/8NPT.100	161	EX1310.25.3.090	167
EX1081.21.160	173	EX1126.32.230	159	EX1310.25.4.070	167
EX1081.21.190	173	EX1126.32.260	159	EX1310.25.6.060	167
EX1081.25.160	173	EX1126.40.260	159	EX1310.29.3.090	168
EX1081.25.190	173	EX1126.40.320	159	EX1310.29.6.065	168
EX1081.29.230	173	EX1126.50.360	159	EX1310.32.4.090	167
EX1081.29.255	173	EX1126.50.420	159	EX1310.32.6.070	167
EX1081.32.210	173	EX1126.63.440	159	EX1310.36.2.150	168
EX1100.07.065	166	EX1126.63.500	159	EX1310.36.4.100	168
EX1100.07.080	166	EX1310.015.07	180	EX1310.40.2.150	167
EX1100.08.035	164	EX1310.015.07	299	EX1310.40.7.090	167
EX1100.08.050	164	EX1310.030.07	180	EX1310.48.3.180	168
EX1100.09.060	166	EX1310.030.07	299	EX1310.48.6.120	168
EX1100.09.080	166	EX1310.040.07	180	EX1310.50.4.100	167
EX1100.10.040	164	EX1310.040.07	299	EX1310.63.3.180	167
EX1100.10.060	164	EX1310.050.07	180	EX1310.63.6.120	167
EX1100.11.055	166	EX1310.050.07	299	EX1530.09.060	189
EX1100.11.085	166	EX1310.060.07	180	EX1530.09.080	189
EX1100.12.065	164	EX1310.060.07	299	EX1530.11.055	189
EX1100.12.080	164	EX1310.070.07	180	EX1530.11.085	189
EX1100.13.080	166	EX1310.070.07	299	EX1530.13.080	189
EX1100.13.110	166	EX1310.09.2.030	168	EX1530.13.110	189
EX1100.16.080	166	EX1310.09.4.015	168	EX1530.16.080	189
EX1100.16.110	166	EX1310.090.07	180	EX1530.16.110	189
EX1100.17.060	164	EX1310.090.07	299	EX1530.17.060	188
EX1100.17.080	164	EX1310.100.07	180	EX1530.17.080	188
EX1100.20.080	164	EX1310.100.07	299	EX1530.20.080	188
EX1100.20.110	164	EX1310.11.2.040	168	EX1530.20.110	188
EX1100.21.125	166	EX1310.11.2.050	168	EX1530.21.125	189
EX1100.21.160	166	EX1310.11.3.030	168	EX1530.21.160	189
EX1100.25.125	164	EX1310.12.3.010	167	EX1530.21.190	189
EX1100.25.160	164	EX1310.120.07	180	EX1530.21.205	189
EX1100.29.190	166			EX1530.25.125	188
EX1100.29.230	166			EX1530.25.160	188

Art.-No. Art.-No.	Seite Page	Art.-No. Art.-No.	Seite Page	Art.-No. Art.-No.	Seite Page
EX1530.25.190	188	EX1540.20.2.050	185	EX1540.63.3.180	185
EX1530.25.205	188	EX1540.20.6.030	185	EX1540.63.440	182
EX1530.29.210	189	EX1540.21.125	184	EX1540.63.460	182
EX1530.29.230	189	EX1540.21.160	184	EX1540.63.480	182
EX1530.29.250	189	EX1540.21.190	184	EX1540.63.520	182
EX1530.29.275	189	EX1540.21.205	184	EX1540.63.6.120	185
EX1530.32.210	188	EX1540.21.3.090	187	EX1571.09.060	183
EX1530.32.220	188	EX1540.21.4.070	187	EX1571.09.080	183
EX1530.32.230	188	EX1540.25.125	182	EX1571.09.2.030	186
EX1530.32.255	188	EX1540.25.160	182	EX1571.09.4.015	186
EX1530.36.285	189	EX1540.25.190	182	EX1571.11.055	183
EX1530.36.305	189	EX1540.25.2.100	185	EX1571.11.085	183
EX1530.36.325	189	EX1540.25.205	182	EX1571.11.2.050	186
EX1530.36.350	189	EX1540.25.3.090	185	EX1571.11.3.030	186
EX1530.40.270	188	EX1540.25.4.070	185	EX1571.13.080	183
EX1530.40.285	188	EX1540.25.6.060	185	EX1571.13.110	183
EX1530.40.300	188	EX1540.29.210	184	EX1571.13.2.050	186
EX1530.40.330	188	EX1540.29.230	184	EX1571.13.3.040	186
EX1530.42.350	189	EX1540.29.250	184	EX1571.16.080	183
EX1530.42.370	189	EX1540.29.275	184	EX1571.16.110	183
EX1530.42.390	189	EX1540.29.3.090	187	EX1571.16.3.060	186
EX1530.42.420	189	EX1540.29.6.065	187	EX1571.16.6.030	186
EX1530.48.430	189	EX1540.32.210	182	EX1571.17.060	181
EX1530.48.450	189	EX1540.32.220	182	EX1571.17.080	181
EX1530.48.470	189	EX1540.32.230	182	EX1571.17.2.030	185
EX1530.48.490	189	EX1540.32.255	182	EX1571.17.4.015	185
EX1530.50.350	188	EX1540.32.4.090	185	EX1571.20.080	181
EX1530.50.370	188	EX1540.32.6.070	185	EX1571.20.110	181
EX1530.50.390	188	EX1540.36.2.150	187	EX1571.20.2.050	185
EX1530.50.420	188	EX1540.36.285	184	EX1571.20.6.030	185
EX1530.63.440	188	EX1540.36.305	184	EX1571.21.125	183
EX1530.63.460	188	EX1540.36.325	184	EX1571.21.160	183
EX1530.63.480	188	EX1540.36.350	184	EX1571.21.190	183
EX1530.63.520	188	EX1540.36.4.100	187	EX1571.21.205	183
EX1540.09.060	184	EX1540.40.2.150	185	EX1571.21.3.090	186
EX1540.09.080	184	EX1540.40.270	182	EX1571.21.4.070	186
EX1540.09.2.030	187	EX1540.40.285	182	EX1571.25.125	181
EX1540.09.4.015	187	EX1540.40.300	182	EX1571.25.160	181
EX1540.11.055	184	EX1540.40.330	182	EX1571.25.190	181
EX1540.11.085	184	EX1540.40.7.090	185	EX1571.25.2.100	185
EX1540.11.2.050	187	EX1540.42.350	184	EX1571.25.205	181
EX1540.11.3.030	187	EX1540.42.370	184	EX1571.25.3.090	185
EX1540.13.080	184	EX1540.42.390	184	EX1571.25.4.070	185
EX1540.13.110	184	EX1540.42.4.100	187	EX1571.25.6.060	185
EX1540.13.2.050	187	EX1540.42.420	184	EX1571.29.210	183
EX1540.13.3.040	187	EX1540.48.3.180	187	EX1571.29.230	183
EX1540.16.080	184	EX1540.48.430	184	EX1571.29.250	183
EX1540.16.110	184	EX1540.48.450	184	EX1571.29.275	183
EX1540.16.3.060	187	EX1540.48.470	184	EX1571.29.3.090	186
EX1540.16.6.030	187	EX1540.48.490	184	EX1571.29.6.065	186
EX1540.17.060	182	EX1540.48.6.120	187	EX1571.32.210	181
EX1540.17.080	182	EX1540.50.350	182	EX1571.32.220	181
EX1540.17.2.030	185	EX1540.50.370	182	EX1571.32.230	181
EX1540.17.4.015	185	EX1540.50.390	182	EX1571.32.255	181
EX1540.20.080	182	EX1540.50.4.100	185	EX1571.32.4.090	185
EX1540.20.110	182	EX1540.50.420	182	EX1571.32.6.070	185

Art.-No. Art.-No.	Seite Page	Art.-No. Art.-No.	Seite Page	Art.-No. Art.-No.	Seite Page
EX1571.36.2.150	186	EX1801.11	172	EX1803.80.40.285	176
EX1571.36.285	183	EX1801.13	172	EX1803.80.40.320	176
EX1571.36.305	183	EX1801.16	172	EX1803.80.42.370	177
EX1571.36.325	183	EX1801.17	171	EX1803.80.42.410	177
EX1571.36.350	183	EX1801.20	171	EX1803.80.48.430	177
EX1571.36.4.100	186	EX1801.21	172	EX1803.80.48.465	177
EX1571.40.2.150	185	EX1801.25	171	EX1803.80.50.370	176
EX1571.40.270	181	EX1801.29	172	EX1803.80.50.410	176
EX1571.40.285	181	EX1801.32	171	EX1803.80.63.460	176
EX1571.40.300	181	EX1801.40	171	EX1803.80.63.500	176
EX1571.40.330	181	EX1803.07.03.065	170	EX1803.83.12.065	178
EX1571.40.7.090	185	EX1803.07.03.080	170	EX1803.83.17	178
EX1571.42.350	183	EX1803.09	170	EX1803.83.20	178
EX1571.42.370	183	EX1803.11	170	EX1803.83.25	178
EX1571.42.390	183	EX1803.12.03.065	169	EX1803.83.32	178
EX1571.42.4.100	186	EX1803.12.03.080	169	EX1803.83.40	178
EX1571.42.420	183	EX1803.13	170	EX1803.83.50	178
EX1571.48.3.180	186	EX1803.16	170	EX1803.83.63	178
EX1571.48.430	183	EX1803.17	169	EX1811.09	172
EX1571.48.450	183	EX1803.20	169	EX1811.11	172
EX1571.48.470	183	EX1803.21	170	EX1811.13	172
EX1571.48.490	183	EX1803.25	169	EX1811.16	172
EX1571.48.6.120	186	EX1803.29	170	EX1811.17	171
EX1571.50.350	181	EX1803.32	169	EX1811.20	171
EX1571.50.370	181	EX1803.36	170	EX1811.21	172
EX1571.50.390	181	EX1803.40	169	EX1811.25	171
EX1571.50.4.100	185	EX1803.42	170	EX1811.29	172
EX1571.50.420	181	EX1803.48	170	EX1811.32	171
EX1571.63.3.180	185	EX1803.50	169	EX1811.40	171
EX1571.63.440	181	EX1803.63	169	EX1813.83.12.065	178
EX1571.63.460	181	EX1803.80.07.060	177	EX1813.83.17	178
EX1571.63.480	181	EX1803.80.07.075	177	EX1813.83.20	178
EX1571.63.520	181	EX1803.80.09.080	177	EX1813.83.25	178
EX1571.63.6.120	185	EX1803.80.09.100	177	EX1813.83.32	178
EX1700.12.10.065	179	EX1803.80.11.085	177	EX1813.83.40	178
EX1700.17.14.060	179	EX1803.80.11.120	177	EX1813.83.50	178
EX1700.17.14.080	179	EX1803.80.12.060	176	EX1813.83.63	178
EX1700.17.14.105	179	EX1803.80.12.075	176	EX1826.17.070	160
EX1700.20.17.080	179	EX1803.80.13.110	177	EX1826.17.100	160
EX1700.20.17.110	179	EX1803.80.13.140	177	EX1826.20.110	160
EX1700.20.19.080	179	EX1803.80.16.110	177	EX1826.20.140	160
EX1700.20.19.110	179	EX1803.80.16.140	177	EX1826.25.150	160
EX1700.20.19.150	179	EX1803.80.17.080	176	EX1826.25.180	160
EX1700.20.21.080	179	EX1803.80.17.100	176	EX1826.32.230	160
EX1700.20.21.110	179	EX1803.80.20.110	176	EX1826.32.260	160
EX1700.20.21.150	179	EX1803.80.20.140	176	EX1826.40.260	160
EX1700.25.21.125	179	EX1803.80.21.160	177	EX1826.40.320	160
EX1700.25.21.160	179	EX1803.80.21.190	177	EX1826.50.360	160
EX1700.25.27.125	179	EX1803.80.25.160	176	EX1826.50.420	160
EX1700.25.27.160	179	EX1803.80.25.190	176	EX1826.63.440	160
EX1700.25.27.205	179	EX1803.80.29.230	177	EX1826.63.500	160
EX1700.32.27.210	179	EX1803.80.29.255	177	EX2450.12.34	180
EX1700.40.36.285	179	EX1803.80.32.210	176	EX2450.17.34	180
EX1700.50.45.370	179	EX1803.80.32.250	176	EX2450.20.34	180
EX1700.63.56.460	179	EX1803.80.36.305	177	EX3500.07.08	191
EX1801.09	172	EX1803.80.36.350	177	EX3500.07.10	191

Art.-No. Art.-No.	Seite Page	Art.-No. Art.-No.	Seite Page	Art.-No. Art.-No.	Seite Page
EX3500.09.08	191	EX3600.21.32	193	F1000.25	139
EX3500.09.10	191	EX3600.21.40	193	F1000.25.125	138
EX3500.09.12	191	EX3600.25.32	192	F1000.25.160	138
EX3500.10.08	190	EX3600.29.40	193	F1000.25.205	138
EX3500.11.08	191	EX3600.29.50	193	F1000.25.85.160	149
EX3500.11.10	191	EX3600.32.40	192	F1000.25.85.190	149
EX3500.11.12	191	EX3600.36.50	193	F1000.32	139
EX3500.11.17	191	EX3600.36.63	193	F1000.32.170	138
EX3500.12.08	190	EX3600.40.50	192	F1000.32.210	138
EX3500.12.10	190	EX3600.42.63	193	F1000.32.255	138
EX3500.13.12	191	EX3600.48.63	193	F1000.32.85.220	149
EX3500.13.17	191	EX3600.50.63	192	F1000.32.85.250	149
EX3500.16.12	191	EX8707.08	194	F1000.4.20	72
EX3500.16.17	191	EX8708.08	194	F1000.4.25	72
EX3500.16.20	191	EX8709.08	194	F1000.4.32	72
EX3500.17.10	190	EX8710.08	194	F1000.40	139
EX3500.17.12	190	EX8711.08	194	F1000.40.240	138
EX3500.20.12	190	EX8712.08	194	F1000.40.285	138
EX3500.20.17	190	EX8713.08	194	F1000.40.330	138
EX3500.21.17	191	EX8716.08	194	F1000.40.85.300	149
EX3500.21.20	191	EX8717.08	194	F1000.50	139
EX3500.21.25	191	EX8720.08	194	F1000.50.330	138
EX3500.25.17	190	EX8721.08	194	F1000.50.370	138
EX3500.25.20	190	EX8725.08	194	F1000.50.420	138
EX3500.29.25	191	EX8729.08	194	F1000.50.85.380	149
EX3500.29.32	191	EX8732.08	194	F1000.63	139
EX3500.32.20	190	EX8736.08	194	F1000.63.400	138
EX3500.32.25	190	EX8740.08	194	F1000.63.460	138
EX3500.36.32	191	EX8748.08	194	F1000.63.520	138
EX3500.36.40	191	EX8750.08	194	F1000.63.85.380	149
EX3500.40.25	190	EX8763.08	194	F1000.63.85.440	149
EX3500.40.32	190	<b>F1 ...</b>		F1000.75	139
EX3500.42.32	191	F1000.06.025	138	F1000.75.500	138
EX3500.42.40	191	F1000.06.030	138	F1000.75.560	138
EX3500.42.50	191	F1000.06.035	138	F1000.75.630	138
EX3500.48.40	191	F1000.08.035	138	F1060.06.025	137
EX3500.48.50	191	F1000.08.050	138	F1060.06.030	137
EX3500.50.32	190	F1000.10.040	138	F1060.08.030	137
EX3500.50.40	190	F1000.10.060	138	F1060.08.040	137
EX3500.63.40	190	F1000.12.050	138	F1060.08.52.030	145
EX3500.63.50	190	F1000.12.065	138	F1060.08.52.040	145
EX3600.07.12	193	F1000.12.080	138	F1060.10.040	137
EX3600.07.17	193	F1000.17	139	F1060.10.060	137
EX3600.08.10	192	F1000.17.045	138	F1060.10.52.040	145
EX3600.09.17	193	F1000.17.060	138	F1060.10.52.060	145
EX3600.09.20	193	F1000.17.080	138	F1060.12.050	137
EX3600.10.12	192	F1000.17.105	138	F1060.12.065	137
EX3600.11.20	193	F1000.17.85.045	149	F1060.12.075	137
EX3600.11.25	193	F1000.17.85.080	149	F1060.12.52.050	145
EX3600.12.17	192	F1000.17.85.100	149	F1060.12.52.065	145
EX3600.13.20	193	F1000.20	139	F1060.12.52.075	145
EX3600.13.25	193	F1000.20.080	138	F1060.17	137
EX3600.16.25	193	F1000.20.110	138	F1060.17.060	137
EX3600.16.32	193	F1000.20.150	138	F1060.17.080	137
EX3600.17.20	192	F1000.20.85.120	149	F1060.17.105	137
EX3600.20.25	192	F1000.20.85.140	149	F1060.17.52.060	145

Art.-No. Art.-No.	Seite Page	Art.-No. Art.-No.	Seite Page	Art.-No. Art.-No.	Seite Page
F1060.17.52.080	145	F1100.08.050	141	F1160.25.190	140
F1060.17.52.105	145	F1100.10.040	141	F1160.32	140
F1060.20	137	F1100.10.060	141	F1160.32.255	140
F1060.20.080	137	F1100.12.050	141	F1160.40	140
F1060.20.110	137	F1100.12.065	141	F1160.40.330	140
F1060.20.145	137	F1100.12.080	141	F1160.50	140
F1060.20.52.080	145	F1100.17	142	F1160.50.420	140
F1060.20.52.110	145	F1100.17.045	141	F1160.63	140
F1060.20.52.145	145	F1100.17.060	141	F1160.63.520	140
F1060.25	137	F1100.17.080	141	F1160.75	140
F1060.25.125	137	F1100.17.105	141	F1160.75.630	140
F1060.25.160	137	F1100.20	142	F1183.12.050	147
F1060.25.190	137	F1100.20.080	141	F1183.12.065	147
F1060.25.52.125	145	F1100.20.110	141	F1183.17	147
F1060.25.52.160	145	F1100.20.150	141	F1183.20	147
F1060.25.52.190	145	F1100.25	142	F1183.25	147
F1060.32	137	F1100.25.125	141	F1183.32	147
F1060.32.210	137	F1100.25.160	141	F1183.40	147
F1060.32.255	137	F1100.25.205	141	F1183.50	147
F1060.32.52.210	145	F1100.32	142	F1183.63	147
F1060.32.52.245	145	F1100.32.170	141	F1184.17	148
F1060.40	137	F1100.32.210	141	F1184.20	148
F1060.40.285	137	F1100.32.255	141	F1184.25	148
F1060.40.330	137	F1100.4.20	72	F1184.32	148
F1060.50	137	F1100.4.25	72	F1184.40	148
F1060.50.370	137	F1100.4.32	72	F1184.50	148
F1060.50.420	137	F1100.40	142	F1184.63	148
F1060.63	137	F1100.40.240	141	F1184.75	148
F1060.63.460	137	F1100.40.285	141	F1184.80.650	148
F1060.63.520	137	F1100.40.330	141	F1184.85.700	148
F1060.75	137	F1100.50	142	F1310.17.2.030	143
F1060.75.560	137	F1100.50.330	141	F1310.17.2.040	143
F1060.75.630	137	F1100.50.370	141	F1310.17.2.050	143
F1083.12.050	147	F1100.50.420	141	F1310.20.2.050	143
F1083.12.065	147	F1100.63	142	F1310.20.2.060	143
F1083.17	147	F1100.63.400	141	F1310.20.2.075	143
F1083.20	147	F1100.63.460	141	F1310.20.3.050	143
F1083.25	147	F1100.63.520	141	F1310.20.3.060	143
F1083.32	147	F1100.75	142	F1310.20.3.065	143
F1083.40	147	F1100.75.500	141	F1310.20.4.050	143
F1083.50	147	F1100.75.560	141	F1310.20.4.060	143
F1083.63	147	F1100.75.630	141	F1310.25.2.070	143
F1084.17	148	F1160.06.025	140	F1310.25.2.090	143
F1084.20	148	F1160.06.030	140	F1310.25.2.100	143
F1084.25	148	F1160.08.030	140	F1310.25.3.070	143
F1084.32	148	F1160.08.040	140	F1310.25.3.090	143
F1084.40	148	F1160.10.040	140	F1310.25.4.070	143
F1084.50	148	F1160.10.060	140	F1310.25.6.060	143
F1084.63	148	F1160.12.050	140	F1310.32.2.115	143
F1084.75	148	F1160.12.065	140	F1310.32.3.090	143
F1084.80.650	148	F1160.12.075	140	F1310.32.3.105	143
F1084.85.700	148	F1160.17	140	F1310.32.4.090	143
F1100.06.025	141	F1160.17.105	140	F1310.32.6.070	143
F1100.06.030	141	F1160.20	140	F1311.17.2.030	144
F1100.06.035	141	F1160.20.145	140	F1311.17.2.040	144
F1100.08.035	141	F1160.25	140	F1311.17.2.050	144

Art.-No. Art.-No.	Seite Page
F1311.20.2.050	144
F1311.20.2.060	144
F1311.20.2.075	144
F1311.20.3.050	144
F1311.20.3.060	144
F1311.20.3.065	144
F1311.20.4.050	144
F1311.20.4.060	144
F1311.25.2.070	144
F1311.25.2.090	144
F1311.25.2.100	144
F1311.25.3.070	144
F1311.25.3.090	144
F1311.25.4.070	144
F1311.25.6.060	144

Art.-No. Art.-No.	Seite Page
F1311.32.2.115	144
F1311.32.3.090	144
F1311.32.3.105	144
F1311.32.4.090	144
F1311.32.6.070	144
F1731.4.20.16	211
F1731.4.25.16	211
F1731.4.32.25	211
F1800.10.03.040	146
F1800.10.03.060	146
F1800.12.03.065	146
F1800.12.03.080	146
F1800.17.03.105	146
F1800.20.03.150	146
F1800.25.03.205	146

Art.-No. Art.-No.	Seite Page
F1800.32.03.255	146
F1800.40.03.330	146
F1800.50.03.410	146
F1800.63.03.520	146
F1800.75.03.630	146
<b>W1...</b>	
W1100.12.95.050	68
W1100.12.95.065	68
W1100.12.95.080	68
W1100.17.95.105	68
W1100.20.95.150	68
W1100.25.95.205	68
W1100.32.95.255	68
W1100.40.95.330	68



**Ansprechpartner AGRO AG**  
Contacts KAISER GmbH & Co. KG

**Technischer Vertrieb**  
Technical Sales

Tel. +41 (0) 62 889 47 47

Weitere Bezugsquellen und Ansprechpartner finden Sie unter [www.agro.ch](http://www.agro.ch)  
oder auf Anfrage unter [info@agro.ch](mailto:info@agro.ch).  
Further sources of supply and contacts can be found at [www.agro.ch](http://www.agro.ch)  
or on request at [info@agro.ch](mailto:info@agro.ch)

Im AGRO-Newsletter und auf unseren Social-Media-Kanälen versorgen wir Sie laufend mit spannenden News.  
In the AGRO newsletter and on our social media channels, we keep you regularly updated with exciting news.



**DEUTSCHLAND**  
GERMANY

**KAISER GmbH & Co. KG**  
Member of KAISER  
GROUP

Ramsloh 4  
58579 Schalksmühle  
DEUTSCHLAND

+49 (0)2355/809-0  
[www.kaiser-elektro.de](http://www.kaiser-elektro.de)  
[info@kaiser-elektro.de](mailto:info@kaiser-elektro.de)

**SCHWEIZ**  
SWITZERLAND

**AGRO AG**  
Member of KAISER  
GROUP

Korbackerweg 7  
5502 Hunzenschwil  
SCHWEIZ

+41 (0)62/88947-47  
[www.agro.ch](http://www.agro.ch)  
[info@agro.ch](mailto:info@agro.ch)

**NIEDERLANDE**  
NETHERLANDS

**ATTEMA B.V.**  
Member of KAISER  
GROUP

Schelluinsestraat 1  
4203 NJ Gorinchem  
NIEDERLANDE

+31 (0)183/650-650  
[www.attema.com](http://www.attema.com)  
[info@attema.nl](mailto:info@attema.nl)

**BELGIEN**  
BELGIUM

**N.V. PLASTIC COLOR**  
Member of KAISER  
GROUP

Industrielaan 10  
9320 Erembodegem  
BELGIEN

+32 (0)53/8505-20  
[www.helia-elektro.be](http://www.helia-elektro.be)  
[info@helia-elektro.be](mailto:info@helia-elektro.be)

Die Liefer- und Zahlungsbedingungen finden Sie auf der Website der Einzelunternehmen.  
The terms of delivery and payment can be found on the companies' website.

# Systeme und Lösungen für die professionelle Installation.

## Systems and solutions for the professional installation.



### **Elektro-Installation.**

Systeme und Lösungen für die professionelle Elektro-Installation in Unterputz-/Mauerwerk-, Hohlwand- und Betonbauweise.

### **Electrical Installation.**

Systems and solutions for professional electrical installation work with flush-mounting/masonry/cavity wall and concrete constructions.



### **E-Mobility.**

EVolution EMC Kabelverschraubung –  
Geschaffen für die anspruchsvolle Elektromobilität.

### **E-Mobility.**

The EVolution EMC cable gland – developed for the most demanding electromobility applications.

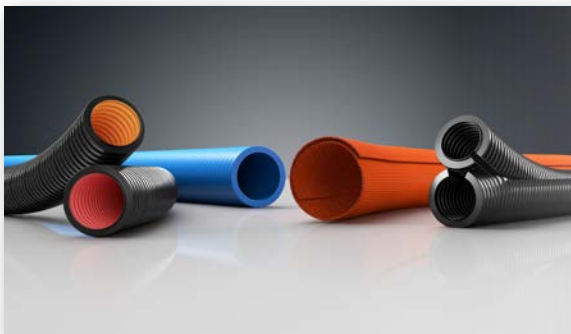

### **Kabelschutzschläuche.**

Produkte für Anwendungen im Maschinen-, Anlagen-, Fahrzeug- und Schienenfahrzeugbau, der Automation oder Energietechnik.

### **Protective cable conduits.**

Products for applications in mechanical engineering, facilities construction, automobile and rolling stock manufacture, automation and energy engineering.

Alle weiterführenden Informationen zu Produkten, Systemlösungen und Kommunikationsmedien finden Sie aktuell auf: [www.agro.ch](http://www.agro.ch).

Please find additional information about products, system solutions and communication media on: [www.agro.ch](http://www.agro.ch).

**AGRO AG**  
CH-5502 Hunzenschwil  
Tel.+41(0)62 889 47 47  
[www.agro.ch](http://www.agro.ch) · [info@agro.ch](mailto:info@agro.ch)  
Member of **KAISER GROUP**

**AGRO**  
Member of **KAISER GROUP**